

/TECHNICAL CATALOGUE/TECHNISCHER KATALOG 2009/

English/Deutsch

2009

TECHNICAL CATALOGUE
TECHNISCHER KATALOG



THE HONEST PRODUCT FOR THE HONEST PRICE



IMPUMP[®]
Intelligent Motor Pumps



IMPPUMPS

THE HONEST PRODUCT FOR THE HONEST PRICE

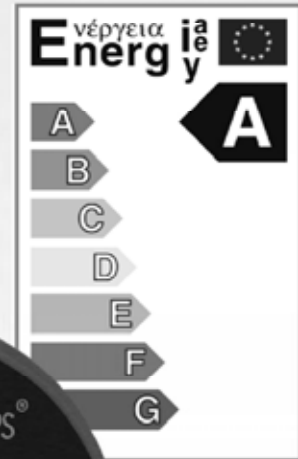

NMT

NEW MOTOR TECHNOLOGY

NMT New Motor Technology circulating pumps / Umwälzpumpen mit New Motor Technology	7
• NMT / Threaded circulation pumps with permanent magnet motor / Verschraubungsumwälzpumpen mit permanent magnet Motor	14
• NMT / Circulation pumps with permanent magnet motor / Umwälzpumpen mit permanent magnet Motor	16
EGHN / EGHN-D / EGHN-L / EGHN-D-L Elektronisch geregelte Heizungsumwälzpumpen / Electronically controlled circulating pumps	23
• EGHN SMART / Variable speed circulating pumps / Elektronisch geregelte Heizungsumwälzpumpen	29
• EGHN / Circulating pumps with built-in frequency converter / Heizungsumwälzpumpen mit stufenloser Differenzdruckregelung - eingebauten Frequenzumformer	30
• EGHN-D / Double circulating pumps with built-in frequency converter / Zwillingsumwälzpumpen mit stufenloser Differenzdruckregelung - eingebauten Frequenzumformer	33
• EGHN-L / Circulating pumps with separated frequency converter / Heizungsumwälzpumpen mit stufenloser Differenzdruckregelung - abwickelbar Frequenzumformer	36
• EGHN-D-L / Double circulating pumps with separated frequency converter / Zwillingsumwälzpumpen mit stufenloser Differenzdruckregelung - abwickelbar Frequenzumformer	38
GHN / GHN-D / GHN-M / GHN-M-D Three speeds circulating pumps / Drehzahlkonstante Heizungsumwälzpumpe	43
• GHN / Threaded circulation pumps with three speeds / Verschraubungsumwälzpumpen mit manueller Drehzahlumschaltung 3 Drehzahlstufe	44
• GHN-D / Threaded twin circulation pumps with three speeds / Dreistufige Zwilling Verschraubungsumwälzpumpen mit manueller Drehzahlumschaltung	48
• GHN / Three speeds circulation pumps with flanges / Flanschumwälzpumpen mit manueller Drehzahlumschaltung 3 Drehzahlstufe	51
• GHN-D / Three speeds double circulation pumps with flanges / Zwillingsumwälzpumpen mit manueller Drehzahlumschaltung 3 Drehzahlstufe	56
• GHN-M / Three speeds circulation pumps with flanges / Flanschumwälzpumpen mit manueller Drehzahlumschaltung 3 Drehzahlstufe	61
• GHN-M-D / Three speeds double circulation pumps with flanges / Zwillingsumwälzpumpen mit manueller Drehzahlumschaltung 3 Drehzahlstufe	64
SAN Circulating pumps for sanitary water / Brauchwasser Zirkulationspumpen	75
• SAN / Threaded pumps for circulation of sanitary water with three speeds / Nassläufer Verschraubungs Brauchwasser - Zirkulationspumpen	77
• SAN / Three speed circulation pumps for sanitary water with flanges / Dreistufige Flanschumwälzpumpen mit manueller Drehzahlumschaltung für Brauchwasser	80
ECL Electronically controlled in-line pumps / Elektronisch geregelte Trockenläuferpumpen	85
• ECL / In-line pumps with separate frequency converter / Elektronisch geregelte Inlinepumpen mit integrierter Differenzdruckregelung mit abwickelbar Frequenzumformer	90
CV / CL / CLD In-line pumps / Trockenläuferpumpen	99
• CV / Standard in-line pumps / Standard - Inline Pumpen	101
• CL / Standard in-line pumps / Standard - Inline Pumpen	103
• CLD / Standard double in-line pumps / Standard - Inline Pumpen - Doppelauslegung	112
CB Block pumps / Trockenläuferpumpen	131
• CB / Block pumps / Blockpumpen	133
PV / CLP Circulating pumps for sanitary water / Brauchwasser Zirkulationspumpen	143
• PV / In-line pumps for circulation of sanitary water / Trockenläufer - Inline - Brauchwasserpumpen	145
• CLP / In-line pumps for circulation of sanitary water / Trockenläufer - Inline - Brauchwasserpumpen	147

MANUFACTURING RANGE OF IMP PUMPS

The major part of the manufacturing range of IMP PUMPS comprises pumps for the forced circulation of hot or cold water in heating, cooling, air conditioning and airing systems. With products from our strategic partners we can also offer customers pumps from other European manufacturers such as submerged and multi-phase pumps and drinking water systems, pumping systems for sewage and other specialist pumps for conveying liquid media.

Pumps from our range are divided with respect to the method of motor drive on the pump into wet-running rotor pumps and dry-running rotor pumps.

Wet-running rotor pumps

In wet-running rotor pumps the rotor of a special electric motor is submerged in the media. A divided insert built into the electric motor protects the stator coil from the media. The insert is made from non-magnetic alloyed steel. The shaft is of stainless material and rotates on graphite bearings. The bush is static. The media pumped under pressure through the system both cools the pump and reduces friction in the bearings.

Wet-running rotor pumps are noiseless and require little maintenance. They can be regulated with an e-commutator motor (NMT) or frequency converter (EGHN). Within the group of wet-running rotor pumps are also three-speed pumps.

Dry-running rotor pumps

In dry-running rotor pumps the rotor is a part of a standard electric motor fixed to the hydraulic pump casing with an O-ring. The electric motor and pump can be connected by a single shaft or split shaft with a clutch. The shaft is made from stainless material and rotates on axial-radial bearings. The bush is dynamic with floating seals. The media pumped under pressure through the system acts as a lubricant for rubbing surfaces on the floating seal that can be of various designs adapted to the kind of media.

HERSTELLUNGSPROGRAMM IMP PUMPS

Der Hauptteil des Herstellungsprogramms von IMP PUMPS umfasst Pumpen für den Zwangsumlauf von Warm- und Kaltwasser in Heiz- und Kühlsystemen und zur Vorbereitung von Luft und Lüftung. Mit unserem Artikelergänzungsprogramm und mit Dienstleistungen strategischer Partner bieten wir auch Pumpen anderer europäischer Hersteller an: Tauchpumpen und mehrstufige Pumpen und Systeme für Trinkwasser, Pumpsysteme für Fäkalien und andere Spezialpumpen für den Transport flüssiger Medien.

Die Pumpen aus unserem Herstellungsprogramm teilen wir hinsichtlich ihrer Motorenantriebsart in Pumpen mit einem nass laufenden Rotor und Pumpen mit einem trocken laufenden Rotor ein.

Pumpen mit nass laufendem Rotor

Bei Pumpen mit nass laufendem Rotor ist der Rotor eines besonderen Elektromotors im Medium versunken. Die Kammerbuchse, die im Gehäuse des Elektromotors eingebaut ist, schützt die Ständerwicklung vor dem Nasswerden. Die Buchse ist aus nichtmagnetischem, hochlegiertem Stahl hergestellt. Die Welle besteht aus rostfreiem Material und ist mit Grafitlagern gelagert. Die Abdichtung ist statisch. Das Medium, das die Pumpe durch das System drückt, funktioniert in der Pumpe auf zwei Arten -es kühlt die Pumpe und verringert die Reibung der Lager.

Pumpen mit nass laufendem Rotor sind geräuschlos und in der Instandhaltung anspruchslos. Hinsichtlich der Regulationsart können sie mit einem e-kommutierten Motor (NMT) oder mit einem Frequenzumspanner (EGHN) reguliert werden. Zu der Gruppe der Pumpen mit nass laufendem Rotor gehören auch Pumpen mit drei Geschwindigkeiten.

Pumpen mit trocken laufendem Rotor

Bei Pumpen mit trocken laufendem Rotor ist der Rotor Teil des Standardelektromotors, der mit einem Flansch am hydraulischen Gehäuse der Pumpe befestigt ist. Der Elektromotor und die Pumpe können durch eine Einheitswelle oder durch eine getrennte Welle mit Kupplung verbunden sein. Die Welle ist aus nicht rostendem Material hergestellt und mit einem Axial-Radiallager gelagert. Die Abdichtung ist dynamisch mit Gleitdichtungen. Das Medium, das die Pumpe durch das System drückt, wirkt in der Pumpe wie ein Schmiermittel für die Gleitoberfläche der Gleitdichtung. Die Pumpe gibt es in verschiedenen Ausführungen, die der Medienart angepasst sind.

SELECTION OF APPROPRIATE PUMP

Selection of three-speed pumps

The characteristics of the pumps are expressed in the curves illustrating the head H , power P and efficiency dependant on the flow Q . Data on the necessary flow and pressure drops in the system can be read from project documentation and compared with the technical characteristics of pump on graphs and the appropriate pump chosen.

The calculated point R with coordinates Q_r and H_r is the basis for choosing a pump. Pumps having three-stage revolutions have three Q-H curves and operate as shown in figure 1. The pump will operate in the actual working point D . This point is the intersection of the system hydraulic resistance curve and Q-H curve of the pump.

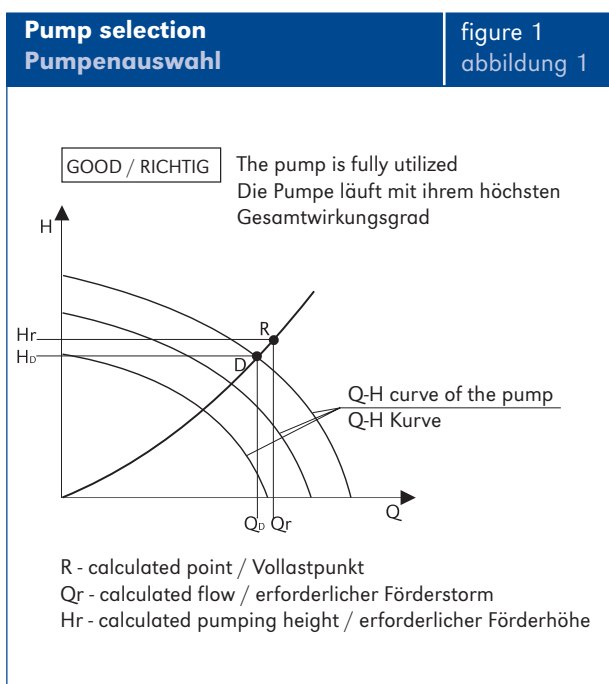

Selection of pump regulation

The operation of electronically regulated pumps is adapted to the requirements of the heating energy consumption in one year. Such an annual consumption can be seen on the graph, figure 2, showing the seasonal profile.

AUSWAHL DER ENTSPRECHENDEN PUMPE

Auswahl der Pumpen mit drei Geschwindigkeiten

Die charakteristischen Eigenschaften der Pumpen sind durch Kurven ausgedrückt und veranschaulichen den Verlauf der Druckhöhe H , der Leistung P und der Ausnutzung in der Abhängigkeit vom Durchfluss Q . Die Angabe über den erforderlichen Durchfluss und über den Druckabfall im System ist aus der Projektdokumentation ersichtlich, wir vergleichen sie mit den technischen Charakteristika der Pumpen auf den Grafen und wählen die entsprechende Pumpe aus.

Der errechnete Punkt R mit den Koordinaten Q_r und H_r ist Grundlage zur Auswahl der Pumpe. Die Pumpe, die drei Umdrehungsstufen hat, hat drei Q-R Kurven und funktioniert wie auf Abb. 1 aufgezeigt. Die Pumpe wird im tatsächlichen Arbeitspunkt D funktionieren. Dieser Punkt ist der Kurvenschnittpunkt des hydraulischen Systemwiderstands und der Q-H Kurve der Pumpe.

Auswahl der regulierten Pumpen

Das Funktionieren der elektronisch regulierten Pumpen ist den Erfordernissen des Verbrauchs der Heizenergie im Jahresabschnitt angepasst. Den Verlauf eines solchen durchschnittlich erforderlichen Verbrauchs sehen wir auf dem Grafen der Abb. 2, der ein saisonbelastetes Profil darstellt.

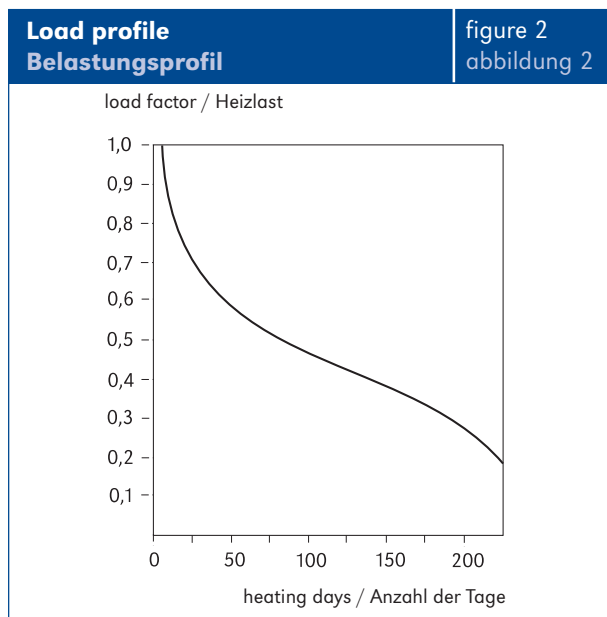

The correct choice of pump regulation (comparing the project requirements of pump characteristics with actual technical characteristics of certain pumps) is shown in figures 3, 4 and 5.

Das richtige Auswählen der regulierten Pumpen (Vergleichen der projektbedingten Charakteristika der Pumpe mit den tatsächlichen technischen Charakteristika einer Pumpe) ist auf Abb. 3, 4 und 5 dargestellt.

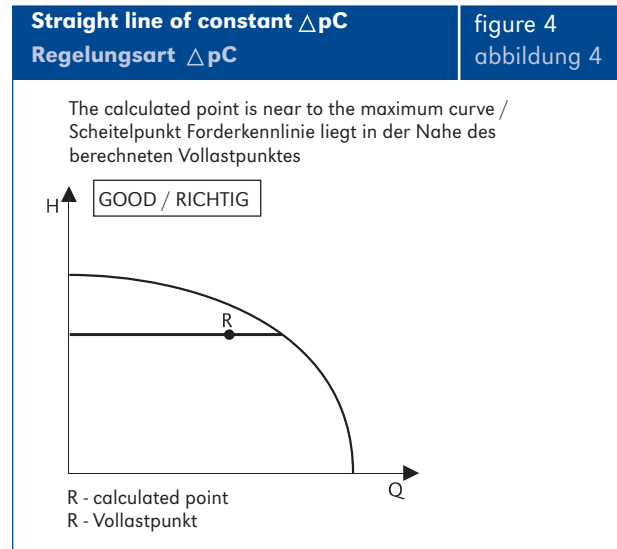
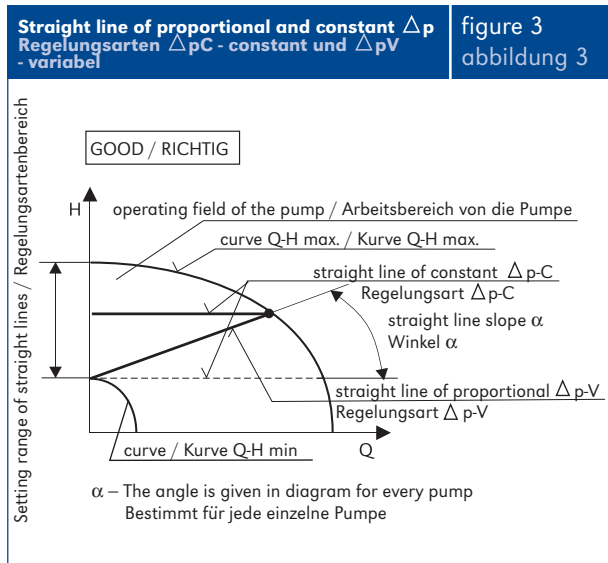

In regulating pumps we have available a complete field of operation of pumps between the maximum and minimum operating curve Q-H. We therefore call these regulations non-stage regulations. The calculated point R should be as close as possible to the maximum operating curve Q-H. From the figure of loading profiles we can read that the heating system operates with full thermal power for only few days in the year with the other days regulation reducing the electricity consumption. In the case of an optimal control system (also using thermostatic valves on the heater) a large part of the electrical energy is saved by regulating pumps. The installation of regulated pumps rather than non-regulated pumps, therefore, provides a great saving.

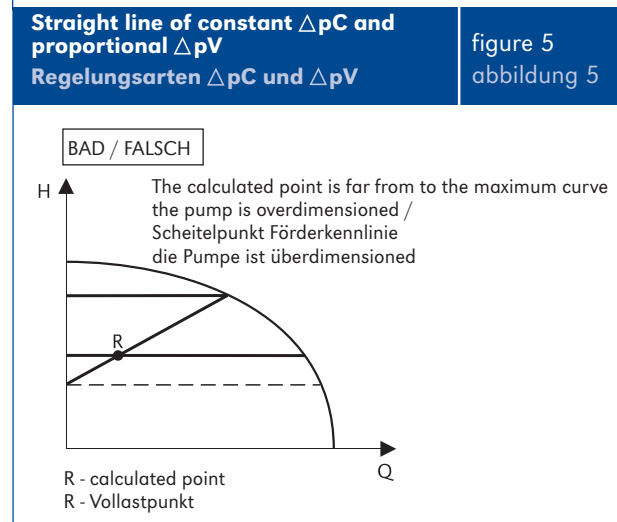

These savings are shown in figure 6.

Tage im Jahr arbeitet, an den übrigen Tagen verringert die Regulierung den Stromverbrauch. Im Falle der optimalen Steuerung des Systems (auch mit Hilfe von Thermostatventilen an den Heizungen) sparen wir mit regulierten Pumpen einen großen Teil der eingebrachten elektrischen Energie. Deshalb ermöglicht der Einbau von regulierten Pumpen anstelle von nicht regulierten eine große Einsparung.

Bei den regulierten Pumpen haben wir das gesamte Funktionsfeld der Pumpe zwischen der maximalen und minimalen Funktionskurve Q-H zur Verfügung. Deshalb nennen wir diese Regulierung stufenlose Stetigkeitsregulierung. Der Rechnungspunkt R sollte möglichst nahe der maximalen Funktionskurve Q-H liegen.

Aus der Abbildung des Belastungsprofils ist ersichtbar, dass das Heizsystem mit voller Wärmeleistung nur einige

Diese Einsparungen sind auf der Abbildung 6 dargestellt.

**Energy savings when using circulating pumps
Anlagenkennlinien bei Teillast**

figure 6
abbildung 6

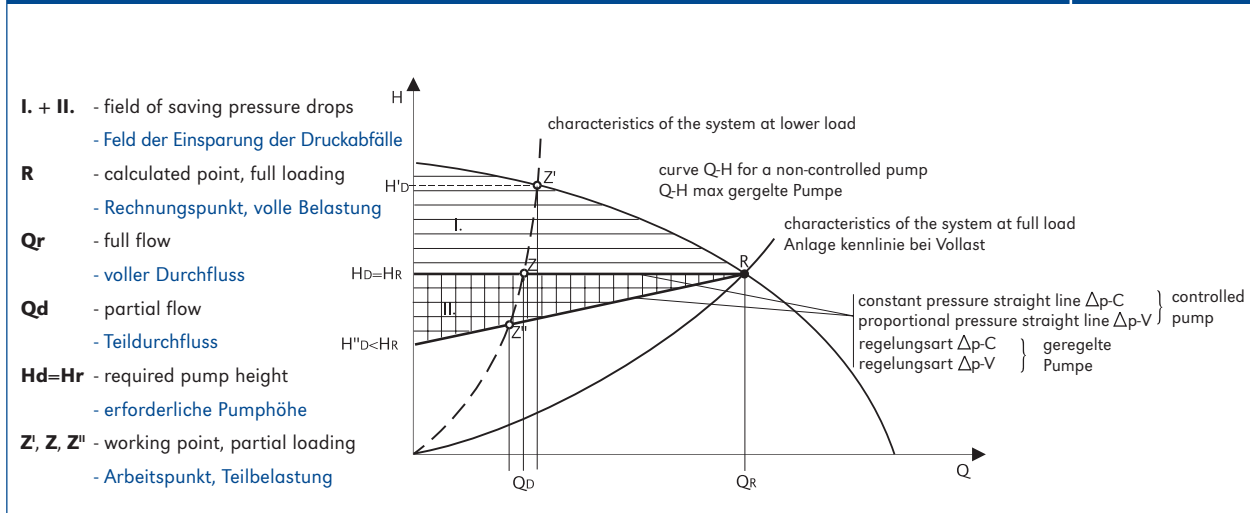

**TECHNICAL CHARACTERISTICS OF
REGULATED PUMPS**

**TECHNISCHE CHARAKTERISTIKA DER
REGULIERTEN PUMPEN**

Media viscosity

Viskosität der Medien

All hydraulic and other data in the technical catalogue apply to the media of water with cinematic viscosity of 1 mm²/s at 18 deg. C.

Alle hydraulischen und anderen Angaben im technischen Katalog gelten für das Medium Wasser mit einer kinematischen Viskosität = 1mm²/s bei einer Temperatur von 18°C.

If not stated for individual pumps, the normal pump operation must be found for the media, which is clean, normally flowing warm water (according to VDI 2035 standard that specifies the hardness and Ph of water), without aggressive or explosive additives, without mixtures of mineral oils or solid or fibrous particles. The cinematic viscosity of the water can be to 10cSt (mm²/s).

Wenn es bei den einzelnen Pumpen nicht besonders angeführt ist, muss für eine normale Funktionsfähigkeit der Pumpen ein Medium garantiert sein, das sauber ist, normales flüssiges Heizwasser (nach VDI 2035 Standard, der die Härte und den PH-Wert des Wassers bestimmt), ohne aggressive oder explosive Zusätze, ohne Beimischungen von Mineralöl und harten oder faserigen Teilen. Die kinematische Viskosität des Wassers kann bis zu 10 cSt (mm²/s) betragen.

If the viscosity of the water is between 1 and 10 cSt (mm²/s), the addition of antifreeze (e.g. glykol) for protecting the heating system does not adversely affect the pump. In planning systems for cooling it is necessary when choosing the pump to take into account changes in hydraulic parameters and power due to increased viscosity and density of the media.

Wenn die Viskosität des Wassers im Bereich von 1 bis 10 cSt (mm²/s) liegt, hat die Zugabe von Antifrostschutzmitteln (z.B. Glykol) keinen größeren Einfluss auf die Pumpe. Bei der Planung von Kühlsystemen sind bei der Auswahl der Pumpen wegen der größeren Viskosität und Dichte des Mediums die Veränderungen der hydraulischen Parameter und der Leistung zu beachten.

Required system pressure

In order that the pump operates without noise and cavitations, in addition to other conditions (choosing appropriate pumps, positions, assembly) the appropriate pressure in the system must be found. IMP PUMPS will provide detailed information on this.

Minimum media flow















The media the pump forces around the system also acts as a coolant for the pump. The minimum flow the pump provides is 5% of the maximum flow for the same pump. We do not recommend running with closed valves.

Erforderlicher Systemdruck

Damit die Pumpe ohne Geräusche und Kavitation funktioniert, müssen wir neben den übrigen Bedingungen (Auswahl der entsprechenden Pumpe, Lage, Montage) einen entsprechenden Druck im System gewährleisten. Ausführlichere Informationen erhalten Sie im Unternehmen IMP Pumps.

Minimaler Durchfluss des Mediums

Das Medium, das die Pumpe durchs System drückt, dient auch der Kühlung der Pumpe. Der minimale Durchfluss, den die Pumpe gewährleisten muss, beträgt 5% des maximalen Durchflusses der gleichen Pumpe. Wir raten vom Betrieb bei geschlossenen Ventilen ab.

LEGEND OF SYMBOLS / BILDZEICHEN	
Electrical voltage / Elektroanschluss	 230 V  400 V
Connection type / Rohranschluss	 screw type / gewind  flanges / flansche
Lenght / Einbaulänge	 110 mm  130 mm  180 mm
Casing type / Werkstoffe	 bronze for sanitary water / bronze - dementsprechend für Brauchwasser
Duble pump / Bautormausführung	 single pump / einzel  double pump / zwillingpumpe
Speed range / Drehzahlbereich	 1500 min ⁻¹  3000 min ⁻¹
Electrical scheme / Elektrische Daten	
Dimensions data / Maße	

IMP PUMPS holds the quality certificates ISO 9001:2000 and SIQ. Most of our pumps carry the CE mark of conformity to EU standards and the national mark SVN in conformity to the IEC standards.



We retain the right to alter technical characteristics of IMP PUMPS products without prior notice and the right to errors in the technical catalogue.

IMP Pumps ist Inhaber des Qualitätsstandards ISO 9001:2000 und des SIQ. Die meisten unserer Pumpen haben das Zertifikat "CE" für die Übereinstimmung der Erzeugnisse mit den EU-Standards und das nationale Zertifikatszeichen SVN für die Übereinstimmung der Erzeugnisse mit dem IEC Standards.

Wir behalten uns das Recht auf Veränderungen der technischen Charakteristika der IMP Pumps Erzeugnisse ohne vorherige Benachrichtigung vor, wie auch das Recht auf Fehler im technischen Katalog.

NMT

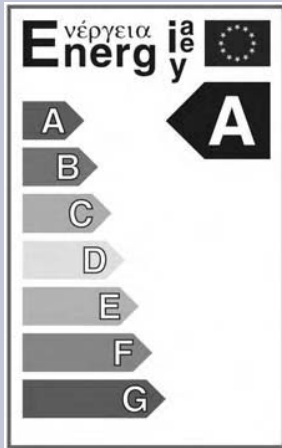

NMT



The New Motor Technology circulating pumps
Umwälzpumpen mit New Motor Technology





IMPUMPMS

THE HONEST PRODUCT FOR THE HONEST PRICE

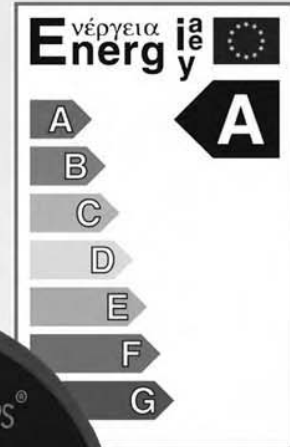

NMT

NEW MOTOR TECHNOLOGY

Circulation pumps with electronically commuted motor Elektronisch geregelte Umwälzpumpen der neuen Technologie

NEW MOTOR TECHNOLOGY PUMP NMT

A new generation of regulated circulation pumps with electronically commuted motor - How does NMT work?

The New Motor Technology (NMT) pumps differ from other similar pumps in that they are driven by an electronically commuted electrical motor with **permanent magnets rotor**. Such electrical motor consumes less energy as asynchronous electrical motor. The electronically commuted electrical motor is driven by frequency converter with integrated PFC filter. Motor is driven by electric current which is rectified and then changed by frequency converter into appropriate shape. Converter measures the motor power consumption and calculates current flow and pressure, which are required data for pump adjustment.

Electronic circuit enables optimal adaptation with power adjustment to the requirements of the hydraulic system and as result energy savings. When there is requirement for low flow operation, the pump could reduce motor power consumption over 5 times and operate at reduced rpm's.

An **ETHERNET communication** provides remote control via HTTP or FTP protocol, ensuring user-friendly environment. The NMT could be self-regulated or could be regulated via PC by WINDOWS application. Optional LonWorks® network connection could be provided.

The NMT pumps achieve significant energy savings compared to other pumps of the same size. The New Motor Technology ensures safe and reliable operation. NMT pumps fulfil the strictest requirements of EU legislation with **"A" energy labelling class**.

Advantages for the investors

NMT pump is designed for energy savings. It saves up to 60% electrical energy compared with three-speed commercial pumps. NMT pumps provide a wide range of operation, and thus simplifying the engineering work, lowering their and installation costs. Low additional installation costs for remote control are ensured by usage of common, non-expensive network devices. Module structure, top quality materials built into the pump and commonly available ETHERNET equipment does not require highly skilled network maintenance personnel.

NMT PUMPEN DER NEUEN MOTORTECHNOLOGIE

Die neue Generation der Umwälzpumpen mit elektronisch komutiertem Motor - Wie funktionieren NMT?

Die Pumpen der neuen Motortechnologie (NMT) unterscheiden sich von den anderen ähnlichen Pumpen durch den Antrieb mittels elektronisch reguliertem **Motor mit Permanentmagneten**. Solcher Motor ist sparsamer im Vergleich zu einem Asynchronmotor, denn zur Rotormagnetisierung wird keine Energie gebraucht.

Der elektronisch regulierte Motor wird durch einen Frequenzrichter mit PFC Netzfilter angetrieben. Der elektrische Strom wird zuerst angesteuert, danach wird er durch den Frequenzrichter in die zum Antrieb des Motors geeignete Form umgewandelt. Der Umrichter misst auch die Motorbelastung und rechnet den Momentdurchfluß und den Druck, als notwendige Regulationsangaben.

Die Elektronik ermöglicht eine optimale Anpassung an die Erfordernisse des hydraulischen Systems durch Regulierung der Leistung und dadurch auch eine Elektroenergieersparnis. Bei niedrigem Durchlaufbedarf können die Pumpen ihre Leistung um 5 x absetzen und bei niedrigerer Drehzahl laufen.

Die angebaute **ETHERNET Kommunikation** gewährleistet eine benutzerfreundliche Anwendung und moderne Fernkontrolle - und Steuerung über HTTP oder FTP Protokoll. Die NMT Pumpe reguliert sich von selbst oder wird über Computer durch die Applikation in WINDOWS-Umfeld gesteuert.

Als Option ist eine LonWorks® Netzverbindung möglich.

Die NMT Pumpen erreichen große Ersparnisse an elektrischer Energie im Vergleich zu anderen Pumpen gleicher Größe. Die neue Motortechnologie ermöglicht vor allem einen sicheren und zuverlässigen Betrieb. Die NMT Pumpen erfüllen die strengsten Forderungen der EU Energie-Gesetzgebung und werden in die **Energie-Klasse "A" rangiert**.

Vorteile für Investoren

Die NMT Pumpe ist für Energieersparnisse projektiert, denn die Pumpen ersparen bis 60% der elektrischen Energie im Vergleich zu klassischen Pumpen.

Die NMT Pumpen gewährleisten eine breite Anwendungspalette und erleichtern dadurch die Arbeit der Projektanten sowie absetzen den Projektierungspreis und die Maschineninstallationskosten. Für Betriebseinstellungen über eine Fernkontrolle werden leicht erhältliche und billige Netzanlagen angewendet, demzufolge können auch die Zusatzeinbaukosten niedrig sein.

Circulation pumps with electronically commuted motor Umwälzpumpen mit elektronisch kommutierten Motor

Mentioned advantages are reasons for the Total Cost of Ownership (TCO) of NMT pumps to be among the lowest for their size.

Advantages for the project engineers

A large range of hydraulic parameter set-ups enable faster pump selection; simplify engineering work and lowering their costs. NMT ensures noiseless operation in the systems with thermostatic valves, fast setting of hydraulic balance and peaceful operation at different system conditions or different operating modes. The hydraulic characteristic of the pump could be set at will. Pump regulation could be done by pressure, speed, electric power or combination of those, so that the pump could be adapted to different hydraulic systems without external regulators.

The pump is using ETHERNET network and Internet protocols for configuration and communication by using existing building network and could be reached to every computer with network connection and internet browser.

There is a configurable relay output and two digital inputs simple remote control.

The pump is overload and over temperature protected. It protects itself from harsh conditions by reducing the power. The pump thereby does not need external overload protection. Potential errors are signalled by a blinking red light. Despite error the pump tries to resume operation until service.

Advantages for the instalers

Due to the NMT pump's fast and simple installation it is technician friendly. Special tools are not required for pump installation. The pump could be connected to network by network maintenance personnel. The pump is installed into hydraulic systems the same way as classic three-speed commercial pumps.

Regular operating shows blue light, while any error is indicated by red light. Setup is simple to make over PC. All setting can be done by common internet tools; as Internet Explorer, Firefox, Netscape, etc.

Moduläre Aufbau, eingebaute Spitzmaterialie und leicht erhältliche ETHERNET Ausrüstung verlangt keine hochspezialisierten Fachleute für Wartung des Netzfeldes, sondern sie kann durch die Servicespezialisten der Computerausrüstung instandgehalten.

Die erwähnten Vorteile begründen einige der niedrigsten Gesamtunterhaltungskosten von NMT Pumpen in der Größenklasse.

Vorteile für Projektanten

Der breite Einstellbereich der hydraulischen Parameter ermöglicht eine schnellere Wahl einer Pumpe, erleichtert die Projektantenarbeit und senkt den Projektierungspreis. Die NMT Pumpe gewährleistet einen lautlosen Betrieb auch im System der zugebauten thermostatischen Ventilen, eine schnelle Aufstellung des hydraulischen Gleichgewichts, ruhige Arbeit in allen Systemangelegenheiten und einen einwandfreien Betrieb in verschiedenen Betriebsarten. Der Pumpe kann eine fast beliebige Kurve eingestellt werden. Zur Verfügung steht eine Druck- und Drehzahlregulierung und Regulierung der Leistung in verschiedenen Kombinationen, damit die Pumpe verschiedenen Systemen ohne externen Regler angepasst werden kann.

Für Einstellungen und Kommunikation verwendet die Pumpe das ETHERNET Netzsystem und Internet Protokolle, damit sie in das schon bestehende Hausnetz verbunden und jedem Rechner mit einer Netzverbindung und Internet-Explorer erreichbar wird.

Ferner werden für eine einfache externe Bedienung auch ein einstellbarer Relaisausgang und zwei Digitaleingänge montiert.

Die Pumpe ist gegen Überbelastung und Überhitzung gesichert. Bei ungünstigen Verhältnissen verringert sie ihre Leistung und sichert sich selbst gegen Beschädigungen. Deswegen wird auch kein Außenschutz gegen Überbelastung benötigt. Die Pumpe meldet eventuelle Defekte durch rote Leuchte. Abgesehen davon setzt die Pumpe nach Möglichkeit den Betrieb fort bis Ankunft des Serviceurs.

Vorteile für Installateure

Dank schneller und einfacher Montage ist die NMT Pumpe ein Installateurfreundliches Gerät. Zu Einbau und Einstellung wird kein spezielles Werkzeug gebraucht. Die Pumpe kann durch jeden, wer mit Computernetzwerk betraut ist, verbunden werden. Die Pumpe wird in das hydraulische System genauso wie die nicht-regulierte Pumpen eingebaut.

Einwandfreier Betrieb wird durch aktivierte blaue Leuchte gemeldet, etwelige Störungen dagegen werden aber durch rote Leuchte signalisiert. Eine einfache Einstellung der Pumpe wird durch Personenrechner gewährleistet. Zur Einstellung genügen gewöhnliche Internetmittel wie Internet Explorer, Firefox, Netscape und andere.

Circulation pumps with electronically commuted motor Umwälzpumpen mit elektronisch kommutierten Motor

Advantages for the environment

The NMT pumps provide significant energy savings and minimum noise to the benefit of the environment compared to other pumps of the same size. NMT pumps satisfy the strictest requirements of EU legislation with "A" energy labelling class.

Design

NMT pumps are in-line designed with motor rotors submerged in the circulated media and inbuilt power electronics, regulator and communications equipment. Single or Twin options are available.

Regulation modes

Automatic regulation of constant pressure difference Δp_C is used in dual pipe systems with thermostatic valves and large user influence such as:

- Devices with working point at low pressure difference
- Devices with strongly choked valves of raised pipes
- Devices with low pressure drops in parts of the system with joint flow (boilers, heat exchangers, joint net works)
- Devices for floor heating with thermostatic valves

By system flow changing the pressure difference will not be changed. By opening TRV valves the pump consumes more electric power.

Automatic regulation of proportional pressure difference Δp_V is used in dual-pipe systems with thermostatic valves and small user influence such as:

- Devices with working point at high pressure difference
- Devices with long pipe network
- Devices with regulated pressure differences in raised pipes
- Devices for floor heating with thermostatic valves and large pressure drops in the primary loop

By increasing of system flow the pressure difference will be increased. By this operating mode in the systems by TRV valves the system flow is increased according to system needs.

Operation by constant speed $N=\text{const}$ provide us pump operation as classic n-speed commercial pumps.

Operation by constant power $P=\text{const}$ provide us limitation of electric consumption. The pressure depends on system flow.

Operation by maximum curve means the pump operates at 100% power.

Umweltvorteile

Die NMT Pumpen gewährleisten große Ersparnisse an elektrischer Energie und eine minimale Umweltschallbelastung im Vergleich zu anderen Pumpen der gleichen Größe. Die NMT Pumpen erfüllen die Erfordernisse strengster Energiegesetzgebung der EU und sind in die "A" Energieklasse klassifiziert.

Ausführung

Die NMT Pumpen haben eine „in-line“ Ausführung mit einem in das Umlaufmedium getauchtem Motorrotor, mit zugebauter Leistungselektronik, Regler und Kommunikationsausrüstung. Sie sind als Einzel- oder Doppelpumpen lieferbar.

Regulationswahl

Die automatische Regulierung der konstanten Druckdifferenz Δp_C wird bei Doppelrohrsystemen mit thermostatischen Ventilen und bei großer Stromverbrauchereinwirkung auf das System angewendet, z.B.:

- Anlagen mit Betriebspunkt bei niedriger Druckdifferenz,
- Anlagen mit stark gedämpften Ventilen in Steigleitungen,
- Anlagen mit niedrigen Druckstürzen in Systemeinzelnheiten mit gemeinsamer Durchführung (Kessel, Wärmeaustauscher, gemeinsames Netzfeld),
- Bodenheizanlagen mit thermostatischen Ventilen.

Durch Durchflußänderung bleibt die Differenz zwischen der Saug- und Druckleitung ungeändert. Die Pumpe reagiert auf ein stärker geöffnetes Ventil mit höherer Leistung.

Die automatische Regulierung der Druckdifferenz Δp_V wird bei Doppelrohrsystemen mit thermostatischen Ventilen und bei kleiner Stromverbrauchereinwirkung auf das System angewendet, z.B.:

- Anlagen mit Betriebspunkt bei hoher Druckdifferenz,
- Anlagen mit langem Abzweignetzfeld,
- Anlagen mit Druckdifferenzregler in Steigleitungen,
- Bodenheizanlagen mit thermostatischen Ventilen und hohen Druckstürzen in primärem Kreis.

Durch höheren Durchfluß steigt auch der Druck zwischen den Anschlüssen. Diese Betriebsart in den Systemen mit thermostatischen Ventilen steigert zusätzlich den Durchfluß nach Bedarf.

Der Betrieb mit konstanter Drehzahl $n=\text{const}$ erlaubt uns einen Betrieb gleichwertig der klassischen nicht regulierten Pumpen mit einer N-Zahl von Geschwindigkeiten.

Die Betriebsart mit konstanter Leistung $P=\text{const}$ erlaubt eine Beschränkung des Pumpenverbrauchs. Der Druck wird stark vom Durchfluß abhängig.

Der Betrieb unter maximaler Kurve bedeutet, daß die Pumpe mit 100% Leistung arbeitet.

Circulation pumps with electronically commuted motor Umwälzpumpen mit elektronisch kommutierten Motor

Standard control functions

Remote control - All parameters could be set-up by ETHERNET communicator. The manual or automatic control by JavaScript programs or similar tools is possible.

- ETHERNET: TCP/IP with HTTP, FTP (the pump is a simple web server)
- Digital inputs for:
 - remote control
 - external power on
 - external regulation
 - operating in pairs (twin pumps)
- Relay output: stand-by, operation, error, etc.

Standard-Steuerungsfunktionen

Fernbedienung / Steuerung - Alle Parameter können über ETHERNET Schnittstelle eingestellt werden. Die Bedienung / Steuerung ist möglich durch Operateur / Handbetrieb oder automatisch durch JavaScript Programme oder durch ähnlichen Werkzeuge.

- ETHERNET: TCP/IP, auf dem HTTP, FTP (die Pumpe ist ein einfacher Web Server)
- Digitaleingänge für:
 - Fernkontrolle
 - Externe Einschaltung
 - Externe Regulierung
 - Einsatz im Doppelpumpenbetrieb
- Relaisausgang: Einsatzbereitschaft, Lauf, Störung / Defekt, anderes

Circulation pumps with electronically commuted motor Umwälzpumpen mit elektronisch kommutierten Motor

TEHNIICAL FEATURES / TECHNISCHE MERKMALE		NMT	NMT	NMTD
Connections / Nenweite	DN (")	15, 20, 25, 32	40 do 80	40 do 80
Connection type / Rohranschluss		Screw Type/Gewind	Flanges / Flansche	Flanges / Flansche
Flow max / Förderstrom max	Q (m³/h)	2,1 / 3,7	65	120
Head max / Förderhöhe	H (m)	3,0 / 5,9	13,5	13,5
Pressure rated / Betriebsdruck	PN (bar)	10	6 / 10	6 / 10
Power max / Leistungsaufnahme max	P (W)	25 / 50	500 - 1600	450 - 1600
Electrical voltage / Elektroanschluss	V	1 x 230 AC	1 x 230 AC	1 x 230 AC
Degree of protection / Schutzart	IP	44	44	44
Regulation / Regelung		Electronically commutated motor/ Permanent magnet motor	Electronically commutated motor/ Permanent magnet motor	Electronically commutated motor/ Permanent magnet motor
Media temperature / Temperaturbereich	T(°C)	+5 do +95	-10 do +110	-10 do +110
Insulating class / Isolationsklasse		H	F	H
Casing type / Werkstoffe		GG / Cast iron	GG / Cast iron	GG / Cast iron
Duble pump / Zwillingspumpe		no / nein	no / nein	yes / ja
APPLICATIONS / EINSATZGEBIETE				
Heating / Warmwasserheizungen		✓	✓	✓
Cooling / Kaltwasseranlagen		✓	✓	✓
Sanitary water / Brauchwasser				
Climate appliances / Klimaanlage		✓	✓	✓
Industry / Industrieanlagen		✓	✓	✓
Process technique / Verfahrenstecnik				
Condensation / Kondensat				
Salt water / Meerwasser				

Pump markings / Typenschlüssel

NMT 25 / 60 – 130 (180)

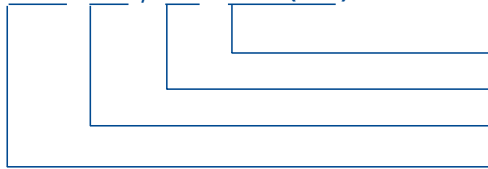

instalation lenght / einbaulänge
max head / förderhöhe
connection size / nennweite **DN**
circulating pump / Umwälzpumpe

Pump markings / Typenschlüssel

NMT (D) 80 – 100 F

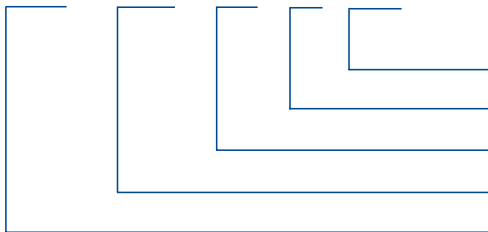

connection type - **Flange** / Rohranschluss - Flansche
max head / förderhöhe
connection size / nennweite **DN**
twin pump - **D** / zwillingsbauform - **D**
pump type / pumpentyp

Permitted mounting positions / Einbaumöglichkeiten

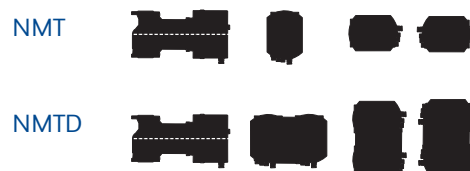
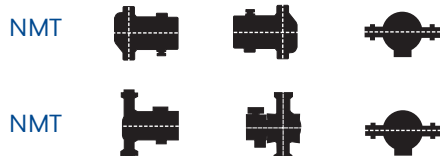

Treated circulation pumps with permanent magnet motor
 Verschraubungsumwälzpumpen mit permanent magnet Motor

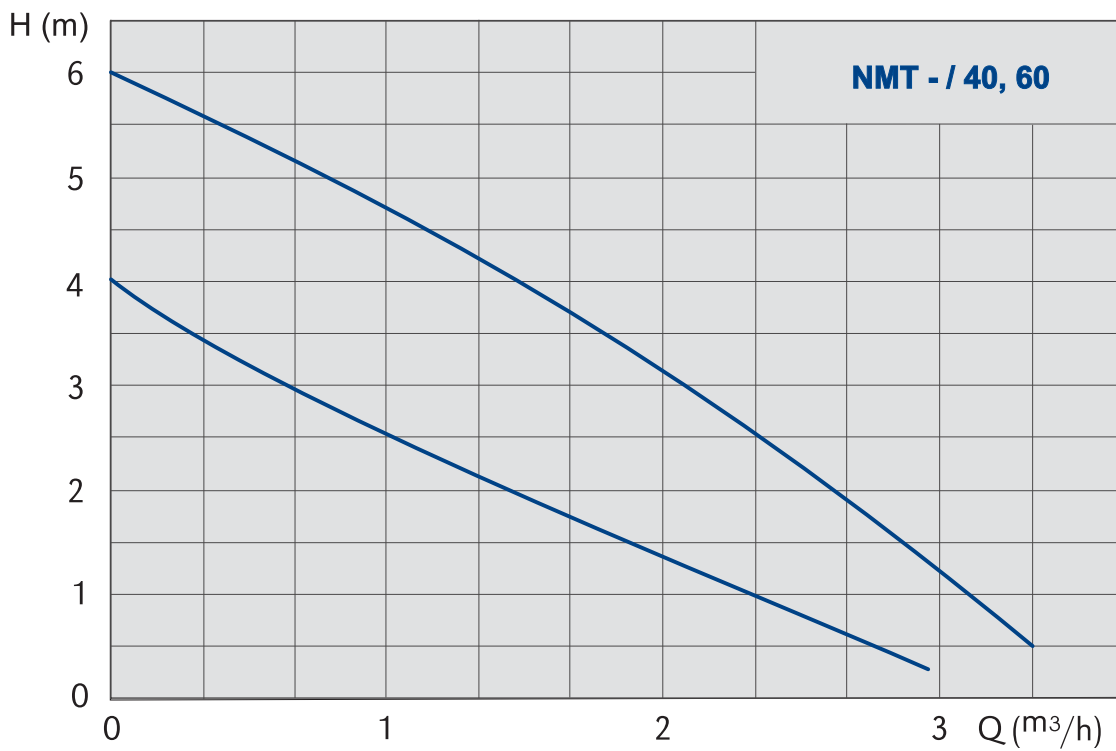
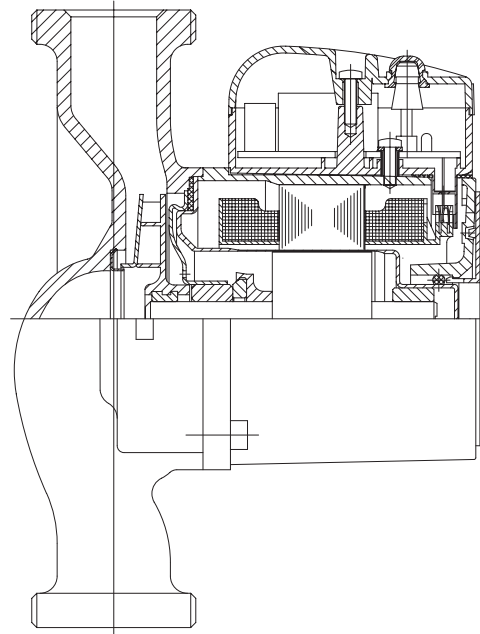
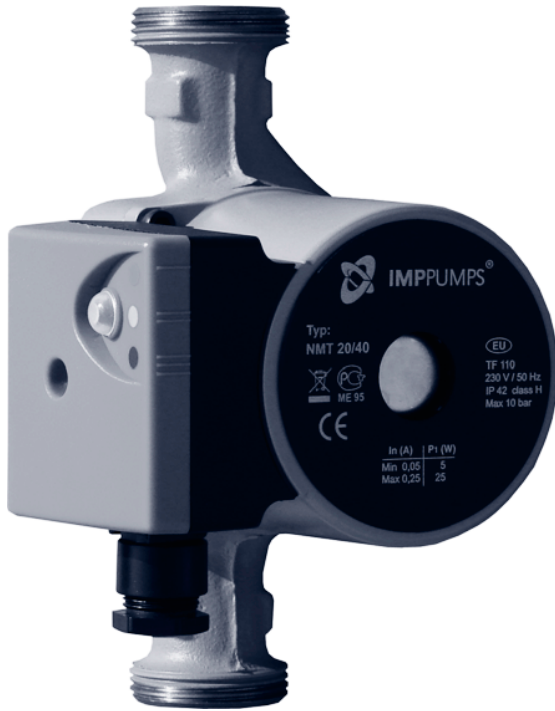

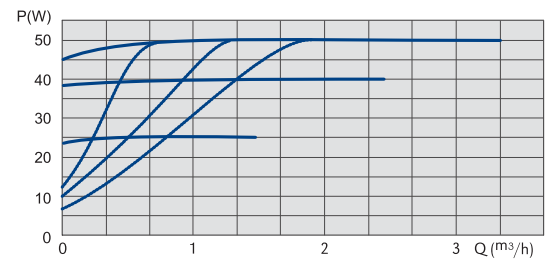
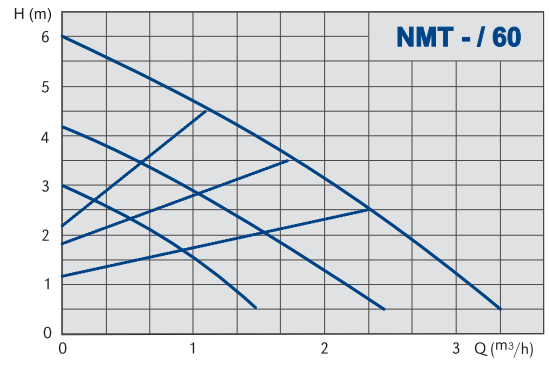
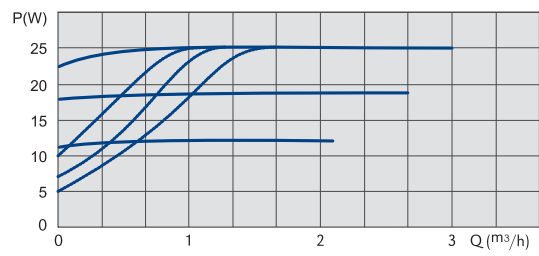
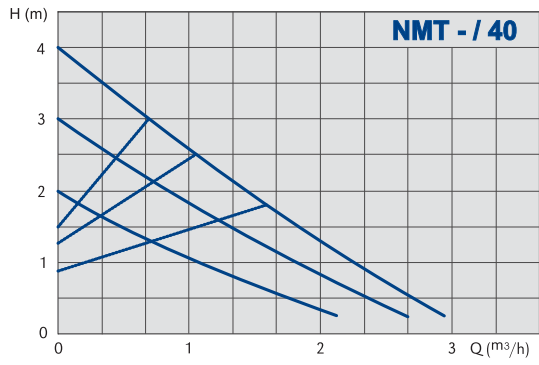

Circulation pumps with permanent magnet motor
Umwälzpumpen mit permanent magnet Motor

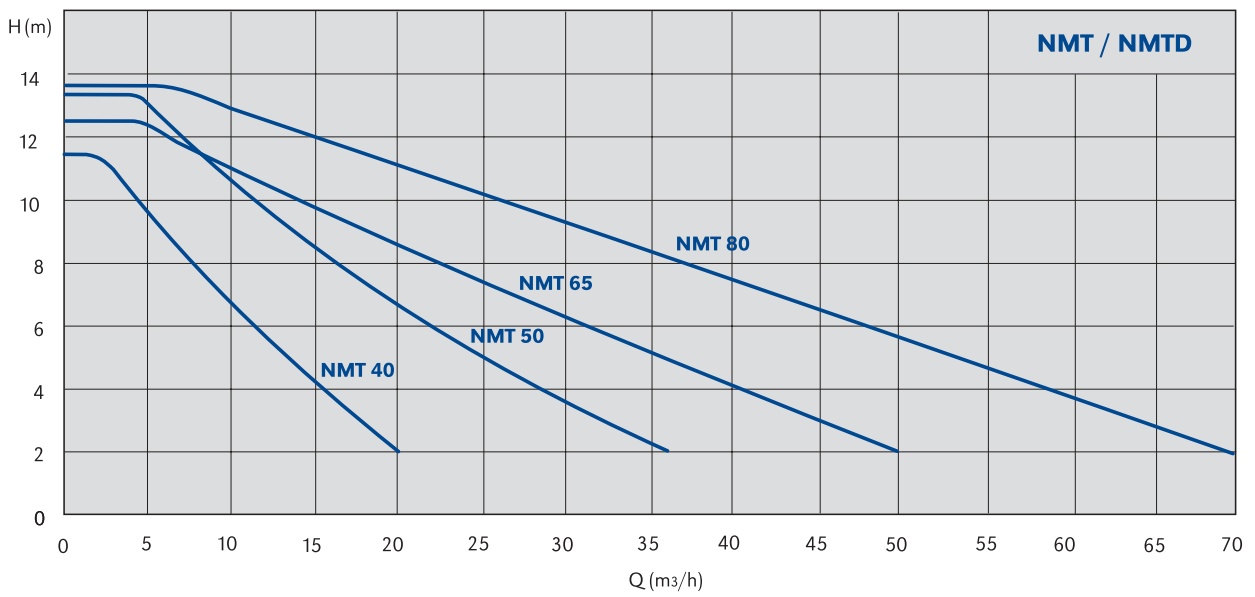
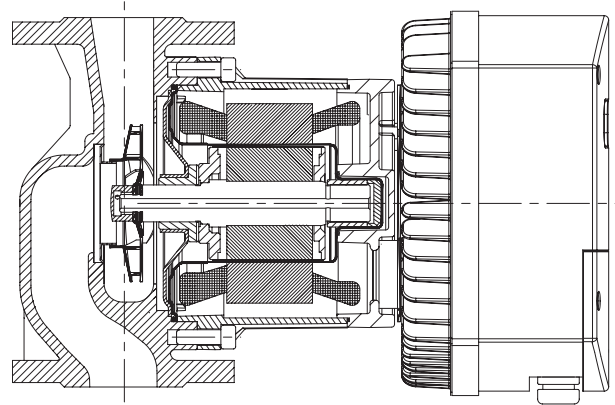

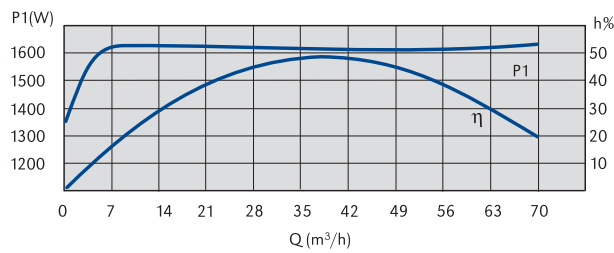
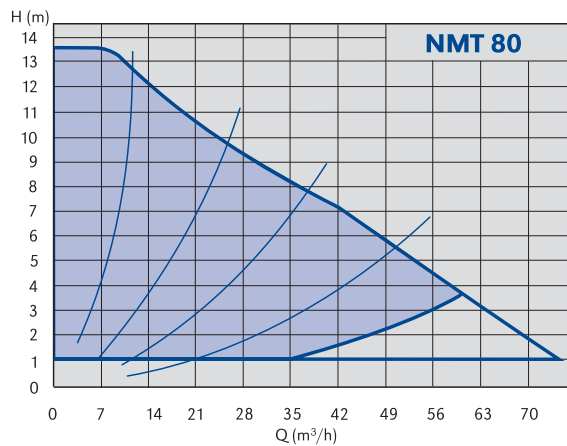
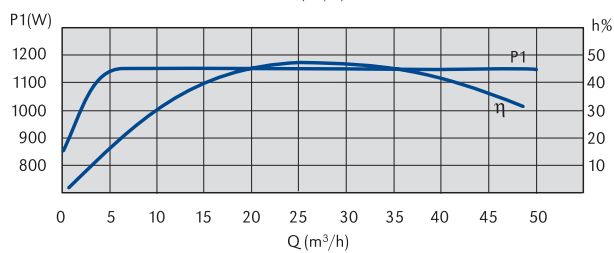
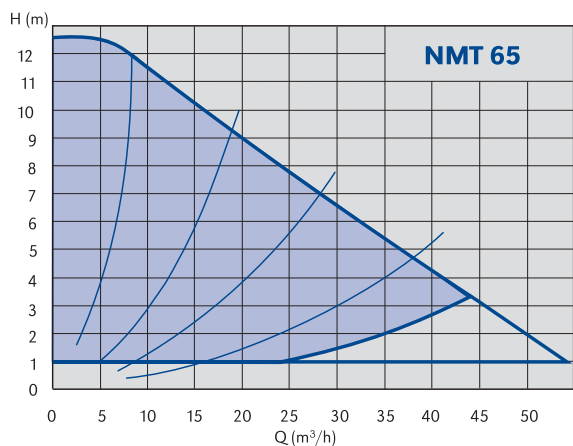
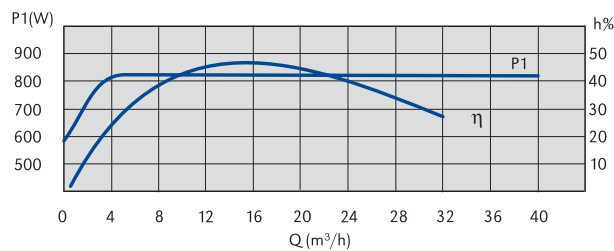
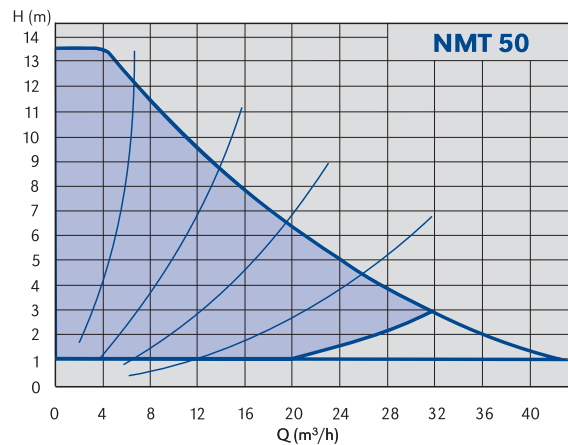
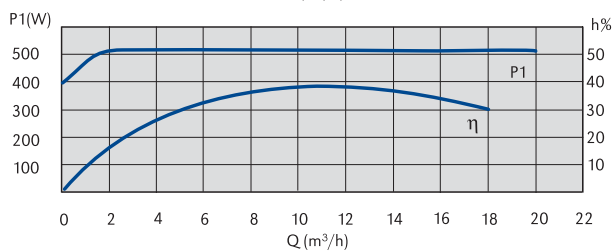
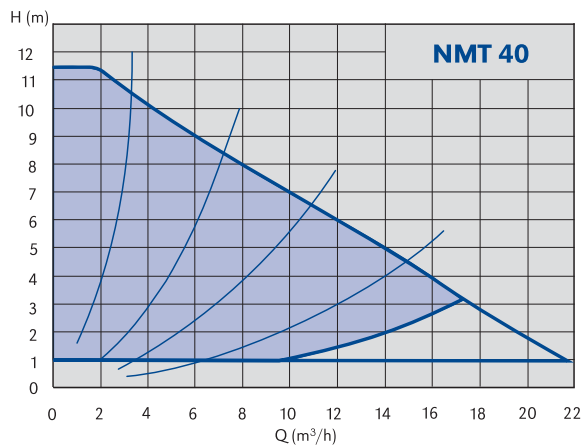

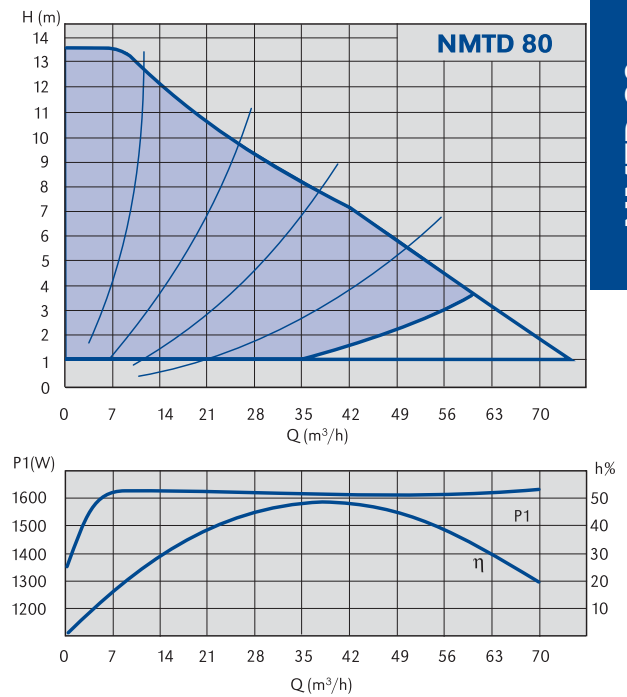
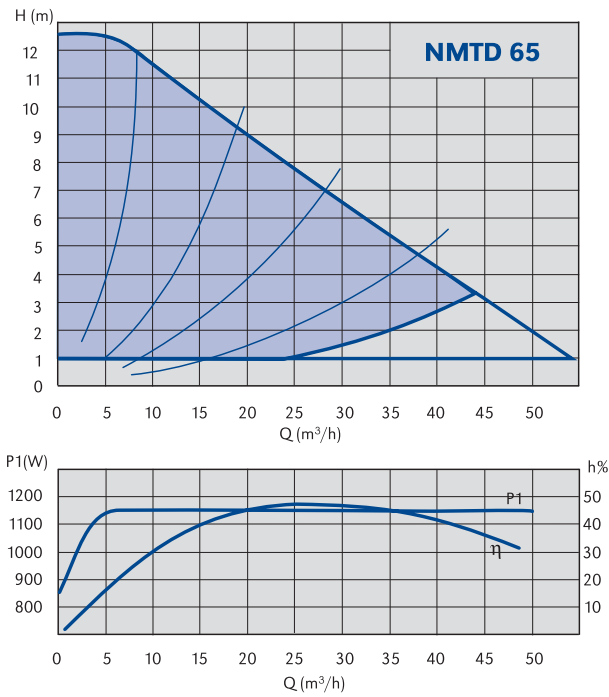
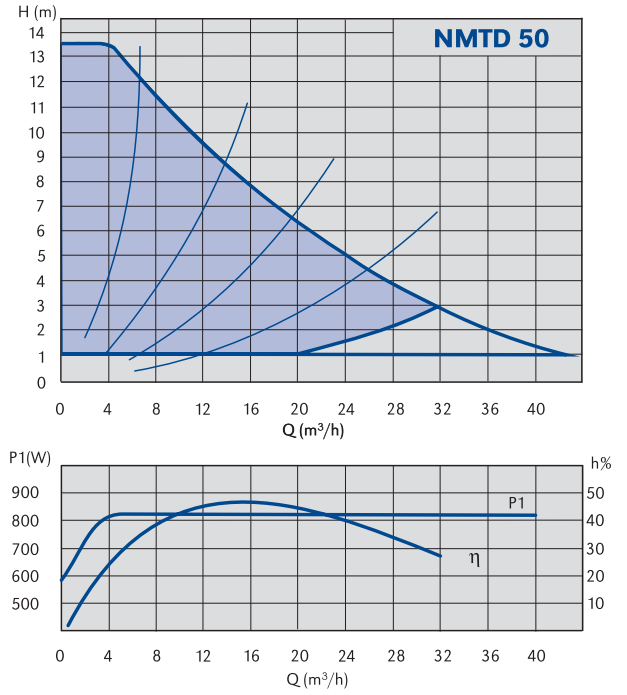
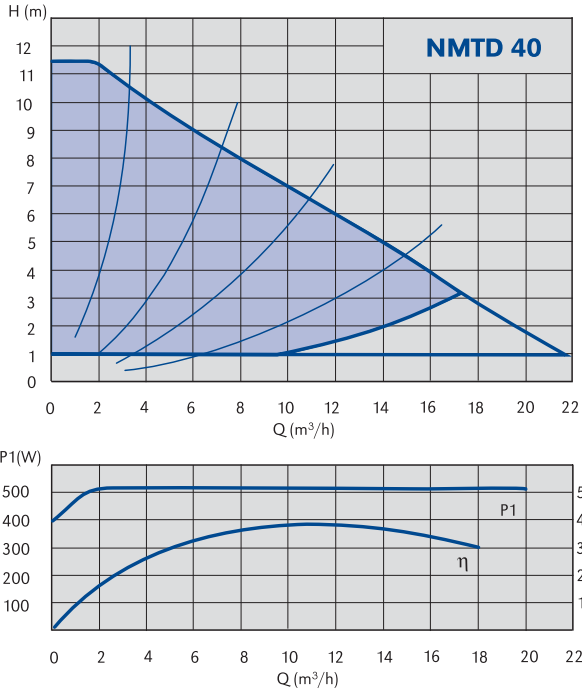

TEHNIICAL DATA / TECHNISCHE DATEN

pump type pumpentyp	code artikelnummer	connection size rohranschluss DN (")	connection type rohranschluss	max. flow durchfluss Q (m ³ /h)	max. head Förder- höhe H (m)	system pressure systemdruck PN (bar)	min. - max. media temperature temp. des medius Tmin-Tmax (°C)	casing type werkstoffe GG / Cast iron	single-S double-D einzelne-E zwillings- bauform-Z	weight gewicht (kg)	regulation geregelt yes / ja no / nein	degree of protection schutzart IP
NMT 15/40 - 130	979522028	DN 15	Flanges/Flansche	2,1	4,2	PN 10	+5 - +95	GG/CI	S / E	1,9	yes/ja	44
NMT 20/40 - 130	979522024	DN 20	Flanges/Flansche	2,1	4,2	PN 10	+5 - +95	GG/CI	S / E	2,1	yes/ja	44
NMT 25/40 - 130	979522025	DN 25	Flanges/Flansche	2,1	4,2	PN 10	+5 - +95	GG/CI	S / E	2,1	yes/ja	44
NMT 15/60 - 130	979522029	DN 15	Flanges/Flansche	3,7	5,9	PN 10	+5 - +95	GG/CI	S / E	1,9	yes/ja	44
NMT 20/60 - 130	979522026	DN20	Flanges/Flansche	3,7	5,9	PN 10	+5 - +95	GG/CI	S / E	2,1	yes/ja	44
NMT 25/60 - 130	979522027	DN 25	Flanges/Flansche	3,7	5,9	PN 10	+5 - +95	GG/CI	S / E	2,1	yes/ja	44
NMT 20/40 - 180	979522042	DN 20	Flanges/Flansche	2,1	4,2	PN 10	+5 - +95	GG/CI	S / E	2,2	yes/ja	44
NMT 25/40 - 180	979522043	DN 25	Flanges/Flansche	2,1	4,2	PN 10	+5 - +95	GG/CI	S / E	2,3	yes/ja	44
NMT 32/40 - 180	979522044	DN 32	Flanges/Flansche	2,1	4,2	PN 10	+5 - +95	GG/CI	S / E	2,7	yes/ja	44
NMT 20/60 - 180	979522046	DN 20	Flanges/Flansche	3,7	5,9	PN 10	+5 - +95	GG/CI	S / E	2,3	yes/ja	44
NMT 25/60 - 180	979522047	DN 25	Flanges/Flansche	3,7	5,9	PN 10	+5 - +95	GG/CI	S / E	2,3	yes/ja	44
NMT 32/60 - 180	979522048	DN 32	Flanges/Flansche	3,7	5,9	PN 10	+5 - +95	GG/CI	S / E	2,7	yes/ja	44
NMT 40	979522736	DN 40	Flanges/Flansche	18	12,5	PN 6/10	-10 - +110	GG/CI	S / E	24	yes/ja	44
NMT 50	979522737	DN 50	Flanges/Flansche	33	16	PN 6/10	-10 - +110	GG/CI	S / E	31	yes/ja	44
NMT 65	979522738	DN 65	Flanges/Flansche	49	14,5	PN 6/10	-10 - +110	GG/CI	S / E	36	yes/ja	44
NMT 80 PN 6	979522739	DN 80	Flanges/Flansche	65	14	PN 6	-10 - +110	GG/CI	S / E	44	yes/ja	44
NMT 80 PN 10	979522740	DN 80	Flanges/Flansche	65	14	PN 10	-10 - +110	GG/CI	S / E	44	yes/ja	44
NMTD 40	979522744	DN 40	Flanges/Flansche	18	12,5	PN 6/10	-10 - +110	GG/CI	D / Z	47	yes/ja	44
NMTD 50	979522745	DN 50	Flanges/Flansche	33	16	PN 6/10	-10 - +110	GG/CI	D / Z	60	yes/ja	44
NMTD 65	979522746	DN 65	Flanges/Flansche	49	14,5	PN 6/10	-10 - +110	GG/CI	D / Z	63	yes/ja	44
NMTD 80 PN 6	979522747	DN 80	Flanges/Flansche	65	14	PN 6	-10 - +110	GG/CI	D / Z	81	yes/ja	44
NMTD 80 PN 10	979522748	DN 80	Flanges/Flansche	65	14	PN 10	-10 - +110	GG/CI	D / Z	81	yes/ja	44

DIMENSIONS / MAßE

	pump type pumpentyp	code artikelnummer	length einbautiefe L (mm)	DN	b1	b2	b3	b4	l	h	h1	a	R	D1	D2	D3	D4	D5	no. hole	
1	NMT 15/40 - 130	979522028	130	15	80	48			108			27			1"					
	NMT 20/40 - 130	979522024	130	20	80	48			108			29			5/4"					
	NMT 25/40 - 130	979522025	130	25	80	48			108			32			6/4"					
	NMT 15/60 - 130	979522029	130	15	80	48			108			27			1"					
	NMT 20/60 - 130	979522026	130	20	80	48			108			29			5/4"					
	NMT 25/60 - 130	979522027	130	25	80	48			108			32			6/4"					
	NMT 20/40 - 180	979522042	180	20	80	48			108			29			5/4"					
	NMT 25/40 - 180	979522043	180	25	80	48			108			32			6/4"					
	NMT 32/40 - 180	979522044	180	32	80	48			108			40			2"					
	NMT 20/60 - 180	979522046	180	20	80	48			108			29			5/4"					
2	NMT 25/60 - 180	979522047	180	25	80	48			108			32			6/4"					
	NMT 32/60 - 180	979522048	180	32	80	48			108			40			2"					
	NMT 40	979522736	250	40	198				321	250		65		40	80	100/110	150	14/19	4	
	NMT 50	979522737	280	50	198				355	280		70		50	90	110/125	165	14/19	4	
	NMT 65	979522738	340	65	198				369	340		80		65	110	130/145	185	14/19	4	
	NMT 80 PN 6	979522739	360	80	198				403	360		100		80	128	150	200	19	4	
3	NMT 80 PN 10	979522740	360	80	198				403	360		100		80	128	160	200	19	8	
	NMTD 40	979522744	250	40	198			403	321	250	110	65		40	80	100/110	150	14/19	4	
	NMTD 50	979522745	280	50	198			403	355	280	121	70		50	90	110/125	165	14/19	4	
	NMTD 65	979522746	340	65	198			452	369	340	141	80		65	110	130/145	185	14/19	4	
	NMTD 80 PN 6	979522747	360	80	198			462	403	360	146	100		80	128	150	200	19	4	
	NMTD 80 PN 10	979522748	360	80	198			462	403	360	146	100		80	128	160	200	19	8	

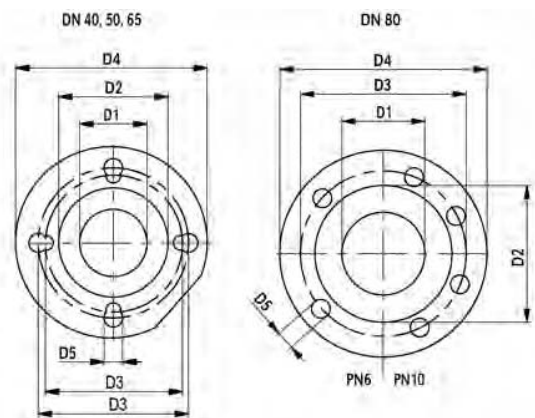
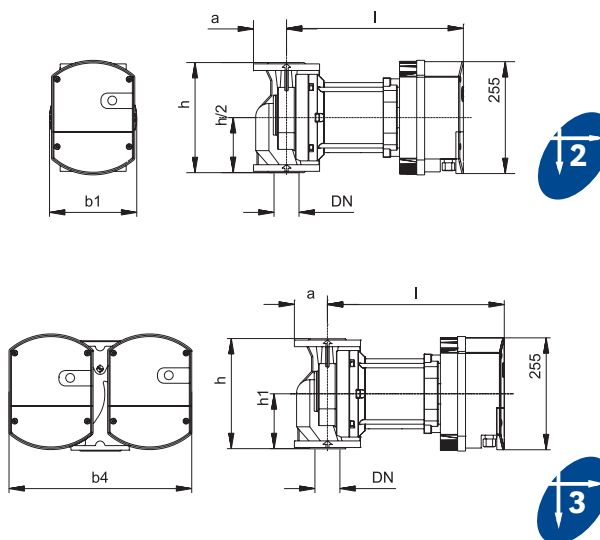
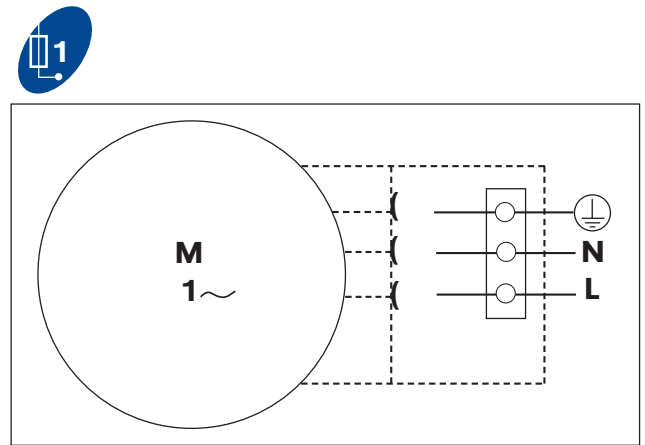
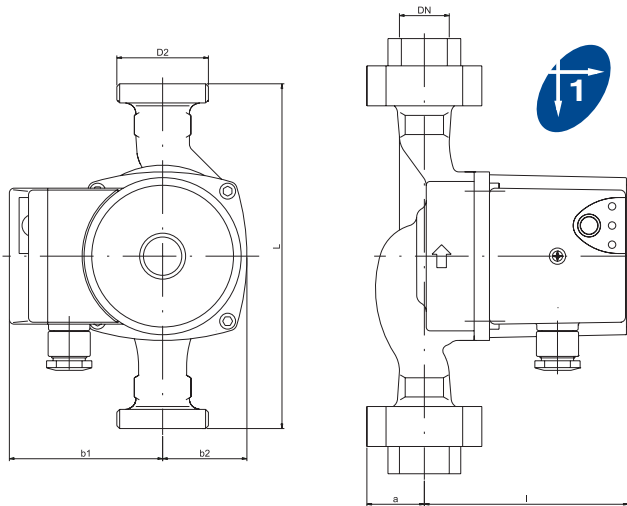



ELECTRICAL DATA / ELEKTRISCHE DATEN							MAX WORKING PRESSURE (bar) MAX ZÜLASSIGER BETRIEBSDRUCK		
pump type pumpentyp	code artikelnummer	power max. leistungsaufnahme P (W)	speed range drehzahlstufe (min-1)	FLC I nennstrom In (A)	electrical voltage elektroanschluss I (V)	insulating class isolationsklasse	temperature / temperatur		
							50°C	80°C	110°C
NMT 15/40 - 130	979522028	25			1 x 230 AC	H			
NMT 20/40 - 130	979522024	25			1 x 230 AC	H			
NMT 25/40 - 130	979522025	25			1 x 230 AC	H			
NMT 15/60 - 130	979522029	50			1 x 230 AC	H			
NMT 20/60 - 130	979522026	50			1 x 230 AC	H			
NMT 25/60 - 130	979522027	50			1 x 230 AC	H			
NMT 20/40 - 180	979522042	25			1 x 230 AC	H			
NMT 25/40 - 180	979522043	25			1 x 230 AC	H			
NMT 32/40 - 180	979522044	25			1 x 230 AC	H			
NMT 20/60 - 180	979522046	50			1 x 230 AC	H			
NMT 25/60 - 180	979522047	50			1 x 230 AC	H			
NMT 32/60 - 180	979522048	50			1 x 230 AC	H			
NMT 40	979522736	500	2720	2,1	1 x 230 AC	H	0,05	0,8	1,4
NMT 50	979522737	900	2870	3,1	1 x 230 AC	H	0,3	1	1,6
NMT 65	979522738	1100	2880	4,2	1 x 230 AC	H	0,3	1	1,6
NMT 80 PN 6	979522739	1600	3200	6,2	1 x 230 AC	H	0,3	1	1,6
NMT 80 PN 10	979522740	1600	3200	6,2	1 x 230 AC	H	0,3	1	1,6
NMTD 40	979522744	500	2720	2,1	1 x 230 AC	H	0,05	0,8	1,4
NMTD 50	979522745	900	2870	3,1	1 x 230 AC	H	0,3	1	1,6
NMTD 65	979522746	1100	2880	4,2	1 x 230 AC	H	0,3	1	1,6
NMTD 80 PN 6	979522747	1600	3200	6,2	1 x 230 AC	H	0,3	1	1,6
NMTD 80 PN 10	979522748	1600	3200	6,2	1 x 230 AC	H	0,3	1	1,6

EGHN / EGHND / EGHN-L / EGHN-L

EGHN / EGHND
EGHN-L / EGHN-L



Electronically controlled circulating pumps /
Elektronisch geregelte Heizungsumwälzpumpen



Electronically controlled circulating pumps Elektronisch geregelte Heizungsumwälzpumpen

ADVANTAGES AND CLARIFICATIONS FOR INSTALLING ELECTRONICALLY REGULATED PUMPS

Saving of energy and money

Due to their regulation of revolutions per minute and power of the motor, electronically regulated pumps attain significantly better conditions of investing energy and work - compared with non-regulated pumps they save on electricity and money.

Optimal adaptation of variables required by the hydraulic system

A wide set-up of hydraulic parameters enables optimal adaptation of the pump to the requirements of the heating system and minimum consumption of electricity.

Noiseless and peaceful operation

The system with electronically regulated pumps runs noiselessly even in the event of heating with thermostatic valves. Due to adapting variables in the system, regulated pumps provide optimal hydraulic balance in the system in all conditions.

Operational safety

Electronically regulated pumps are protected against overloading, short circuits, excessive voltage and excessive temperature.

Reducing environmental pollution

Due to the efficient use of electrical energy, electronically regulated pumps are less burdensome to the environment.

Simplifying projects and reducing costs of mechanical installation

Electronically regulated pumps simplify making projects and the design of mechanical installation.

In some countries the government has legislated to take into account these advantages. For example the German decree of 1994 on heating appliances prescribes circulation pumps for boilers over 50 kW must have at least a three-stage automatic regulation.

VORTEILE UND GRÜNDE FÜR DEN EINBAU ELEKTRONISCH REGULIERTER PUMPEN

Einsparung von Energie und Geld

Die elektronisch regulierten Pumpen erreichen wegen ihrer selbsttätigen Regulierung der Drehzahl und der Motorleistung ein wesentlich besseres Verhältnis zwischen eingebrachter Energie und verrichteter Arbeit, im Vergleich mit nicht regulierten Pumpen ermöglichen sie eine große Einsparung an elektrischer Energie und Geld.

Optimale Anpassung an veränderliche Erfordernisse des hydraulischen Systems

Das weite Feld der Einstellung der hydraulischen Parameter ermöglicht eine optimale Anpassung der Pumpe an die Erfordernisse des Heizsystems bei minimalem Stromverbrauch.

Geräuschloses und ruhiges Funktionieren

Das System mit elektronisch regulierten Pumpen arbeitet geräuschlos auch bei Heizkörpern mit angebauten Thermostatventil. Aufgrund der Anpassung an Veränderungen im System gewährleisten regulierte Pumpen bei allen Verhältnissen ein optimales hydraulisches Gleichgewicht im System.

Funktionsschutz

Elektronisch regulierte Pumpen sind gegen Überlastung, Kurzschluss, Überspannung und gegen zu hohe Temperaturen geschützt.

Verringerung der Umweltverschmutzung

Aufgrund der hohen Auslastung der eingebrachten Energie wird die Umwelt durch elektronisch regulierte Pumpen weniger belastet.

Vereinfachung der Projektierung und Kostenverringerung der Maschineninstallation

Elektronisch regulierte Pumpen vereinfachen dem Projektanten das Projektieren und auch die Ausführung der Maschineninstallation selbst ist einfacher.

Diese Vorteile wurden in einigen Staaten auch von den Regierungen berücksichtigt und eine entsprechende Gesetzgebung vorbereitet. So schreibt die deutsche Verordnung für Heizanlagen aus dem Jahre 1994 vor, dass Umlaufpumpen bei einer Kesselleistung von über 50 kW mit mindestens dreistufigen selbstständigen Regulationen ausgestattet sein müssen.

Electronically controlled circulating pumps Elektronisch geregelte Heizungsumwälzpumpen

ELECTRONICALLY REGULATED PUMPS EGHN

The EGHN electronically regulated pumps provide various media flows in equal or lower heights in changing hydraulic resistances in the system. Changing resistance in the system is normally linked to the operation of hydraulic valves - these changes are recognised by a special pump sensor. A special algorithm in the electronically regulated pump then raises or lowers the rpm of the pump motor with respect to changes in resistance at constant or proportional pressure. Automatic operation of the pump is therefore achieved by setting the pressure for various resistances in the closed loop system of central heating. EGHN electronically regulated pumps are made in two designs - with inbuilt or separate frequency converter.

EGHN pumps with inbuilt frequency converter

These are integrated regulation-drive units that automatically provide the appropriate flow of media in the system. As needed they can be connected to a central controlling system. They are fitted with an electronically protected motor against overheating and a signalisation regime for running and announcing errors.

The EGHN electronically regulated pump with built in frequency converter can perform the following functions:

Automatic regulation of constant pressure difference

The automatic regulation of constant Δp_C is used in dual-pipe systems with thermostatic valves and large user influence such as:

- Devices with working point at low pressure difference
- Devices with strongly choked valves of raised pipes
- Devices with low pressure drops in parts of the system with joint flow (boilers, heat exchangers, joint net works)
- Devices for floor heating with thermostatic valves

ELEKTRONISCH REGULIERTE PUMPEN EGHN

Die elektronisch regulierten Pumpen EGHN gewährleisten verschiedene Durchflüsse von Medien bei gleicher oder niedriger Druckhöhe bei veränderlichen hydraulischen Widerständen im System.

Widerstandsveränderungen im System sind in der Regel mit dem Funktionieren der Thermostatventile verbunden - diese Veränderungen nimmt ein spezieller Fühler der Pumpe wahr. Abhängig von der Widerstandsveränderung im System erhöht oder verringert danach ein besonderer Algorithmus in der Steuerelektronik der Pumpe die Anzahl der Umdrehungen im Pumpenmotor bei konstantem oder proportionalem Druck. Dadurch erreichen wir das selbstständige Funktionieren der Pumpen bei eingestelltem Druck für verschiedene Widerstände im geschlossenen Kreis des Zentralheizungssystems. Wir stellen die elektronisch regulierten Pumpen EGHN in zwei Ausführungen her: mit einem eingebauten oder mit einem getrennten Frequenzumspanner.

EGHN Pumpen mit einem eingebauten Frequenzumspanner

Sie sind eine Regulationsantriebseinheit, die selbstständig für den entsprechenden Durchfluss des Mediums im System sorgt. Bei Bedarf können wir sie mit einem dazugebauten Regulationssystem verbinden. Sie sind mit einem elektronischen Schutz des Motors vor Überhitzung ausgestattet sowie mit einer Betriebssignalisation und einem Fehlermelder.

Die elektronisch regulierten Pumpen EGHN mit eingebautem Frequenzumspanner können folgende Funktionen erfüllen:

Selbstständige Regulierung eines konstanten Druckunterschiedes

Die selbstständig Regulierung eines konstanten Δp_C wird angewandt bei doppelläufigen Systemen mit Thermostatventilen und bei großen autoritären Verbrauchern, wie:

- Anlagen mit einem Arbeitspunkt bei niedrigem Druckunterschied,
- Anlagen mit starken Drosselventilen für Steigleitungen
- Anlagen mit niedrigem Druckabfall in Systemteilen mit einem gemeinsamen Umspanner (Kessel, Wärmeaustauscher, gemeinsames Netz).
- Anlagen für Fußbodenheizungen mit Thermostatventilen

Electronically controlled circulating pumps Elektronisch geregelte Heizungsumwälzpumpen

Automatic regulation of proportional pressure difference

The automatic regulation of proportional ΔpV is used in dual-pipe systems with thermostatic valves and small user influence such as:

- Devices with working point at high pressure difference
- Devices with long pipe network
- Devices with regulated pressure differences in raised pipes
- Devices for floor heating with thermostatic valves and large pressure drops in the primary loop

Operation by maximum curve

Operation by maximum curve is the same as operation of non-regulated pumps at the highest speeds. This method is used in attempting to start the device or when regulation has broken down.

Operation by minimum curve

Operation by minimum curve is the same as operation of non-regulated pumps at the lowest speeds. This method is used in nightly reduction of heating power, at reduced use over weekends or during holidays (in schools, institutions, etc.) and is switched on using a switching timer.

Optional modul for temperature management and for connection to central controlling system could be added to the pump on special request.

EGHN pumps with separate frequency converter

The design of the EGHN pump with separate frequency converter comprises pump, pressure difference measurer (inbuilt into the pump) and separately installed frequency converter (placed on the wall inside or outside the room with the pump).

The advantage of the EGHN pump with separate frequency converter over the EGHN pump with built-in frequency converter is that it can also be used in rooms where the surrounding temperature is over 50 degrees Celsius, increased damp or high dust levels.

Selbstständige Regulierung des proportionalen Druckunterschiedes

Die selbstständige Regulierung des proportionalen ΔpV wird angewandt bei doppelläufigen Systemen mit Thermostatventilen und kleinen autoritären

Verbrauchern, wie:

- Anlagen mit einem Arbeitspunkt mit höheren Druckunterschieden,
- Anlagen mit einem langen Wegenetz,
- Anlagen mit Regulatoren der Druckunterschiede bei Steigleitungen
- Anlagen für Fußbodenheizungen mit Thermostatventilen und mit großem Druckabfall im Primärkreis.

Funktionieren gemäß maximaler Kurve

Das Funktionieren gemäß der maximalen Kurve entspricht dem Funktionieren nicht regulierter Pumpen bei höchster Geschwindigkeit. Diese Art wird angewandt bei versuchsweisem Anfahren von Anlagen oder bei Störungen der Regulierung.

Funktionieren gemäß minimaler Kurve

Das Funktionieren gemäß der minimalen Kurve entspricht dem Funktionieren bei niedrigster Geschwindigkeit. Diese Art wird angewandt bei nächtlicher Verringerung der Heizleistung, bei Bedarfsverringern an Wochenenden oder in Urlaubszeiten (in Schulen, in Institutionen...). Es wird mithilfe einer Schaltuhr eingeschaltet.

EGHN Pumpen mit einem getrennten Frequenzumspanner

Die Ausführung der EGHN Pumpe mit getrenntem Frequenzumspanner besteht aus der Pumpe, dem Druckunterschiedsmesser (angebaut an der Pumpe) und dem getrennt angebrachtem Frequenzumspanner (angebracht an der Wand des Raumes, in dem sich die Pumpe befindet oder auch außerhalb des Raumes).

Electronically controlled circulating pumps Elektronisch geregelte Heizungsumwälzpumpen

EGHN pumps with separate frequency converter enables automatic regulation of rpm with respect to the desired setting of constant pressure and by maximum curve.

Connecting EGHN pumps to the electricity grid

All types of EGHN pumps have a series single-phase connection of frequency converter to the electricity grid. Frequency converters with three-phase connection can be obtained only at special offer. For connecting single-phase frequency converters three wires are used (phase, neutral and earth). The cross section of wire is selected according to the current of the chosen pump. The connection is protected with a melting fuse and the pump does not need protection as protection is built into the frequency converter. We recommend installing a switch between the fuse and frequency converter for switching on and off the frequency converter to allow resetting the pump.

Der Vorteil der EGHN Pumpe mit getrenntem Frequenzumspanner gegenüber der EGHN Ausführung mit eingebautem Frequenzumspanner liegt darin, dass sie auch in Räumen benutzt werden kann, in denen die Umgebungstemperatur über 50 °C liegt und wo es eine höhere Feuchtigkeit und größeres Staubaufkommen gibt.

EGHN Pumpen mit getrenntem Frequenzumspanner ermöglichen die selbstständige Regulierung der Umdrehungen hinsichtlich eines beliebig einstellbaren konstanten Druckes und maximalen Kurven sowie.

Anschließen der EGHN Pumpen an das Stromnetz

Alle Typen der EGHN Pumpen verfügen über einen serienmäßigen Einphasenanschluss des Frequenzumspanners an das Stromnetz. Frequenzumspanner mit einem Dreiphasenanschluss können nur nach einem besonderen Angebot erlangt werden. Zum Anschluss des Einphasenfrequenzumspanners benötigt man einen dreiadrigen Kabel (Phase, Null, Erdung). Die Schnittfläche der Kabel wählen wir abhängig vom Strom der ausgewählten Pumpe. Den Anschluss schützen wir durch eine Schmelzsicherung, wobei die Pumpe selbst nicht geschützt werden muss, denn die gesamte erforderliche Schutzvorrichtung ist im Frequenzumspanner schon eingebaut. Wir empfehlen jedoch den Einbau eines Schalters, zwischen der Sicherung und dem Frequenzumspanner zum Ein- und Ausschalten des Frequenzumspanners, um das Resetieren der Pumpe zu ermöglichen

Electronically controlled circulating pumps Elektronisch geregelte Heizungsumwälzpumpen

TECHNICAL FEATURES / TECHNISCHE MERKMALE	EGHN SMART	EGHN	EGHN-D	EGHN - L	EGHN-D - L
Connections / Nennweite DN (")	15, 20, 25, 32	40 do 80	40 do 80	40 do 80	40 do 80
Connection type / Rohranschluss	Screw Type/Gewind	Flanges / Flansche	Flanges / Flansche	Flanges / Flansche	Flanges / Flansche
Flow max / Förderstrom max Q (m³/h)	3,8	80	140	80	140
Head max / Förderhöhe H (m)	6	12	12	12	12
Pressure rated / Betriebsdruck PN (bar)	10	6 / 10	6	6 / 10	6
Power max / Leistungsaufnahme max P (W)	84	2200	2200	2200	2200
Electrical voltage / Elektroanschluss V	1 x 230 AC	1 x 230 AC	1 x 230 AC	1 x 230 AC	1 x 230 AC
Degree of protection / Schutzart IP	44	43	43	43	43
Regulation / Regelung	yes / ja	Frequency inverter Frequenzumformer	Frequency inverter Frequenzumformer	Frequency inverter Frequenzumformer	Frequency inverter Frequenzumformer
Media temperature / Temperaturbereich T(°C)	+5 do +90	+15 do +110	+15 do +110	+5 do +110	+5 do +110
Insulating class / Isolationsklasse	H	H	H	H	H
Casing type / Werkstoffe	GG / Cast iron	GG / Cast iron	GG / Cast iron	GG / Cast iron	GG / Cast iron
Duble pump / Zwillingpumpe	no / nein	no / nien	yes / ja	no / nien	yes / ja
APPLICATIONS / EINSATZGEBIETE					
Heating / Warmwasserheizungen	✓	✓	✓	✓	✓
Cooling / Kaltwasseranlagen	✓			✓	✓
Sanitary water / Brauchwasser					
Climate appliances / Klimaanlage	✓			✓	✓
Industry / Industrieanlagen	✓	✓	✓	✓	✓
Process technique / Verfahrenstechnik					
Condensation / Kondensat					
Salt water / Meerwasser					

Pump markings / Typenschlüssel

EGHN SMART 25 / 60 - 130 (180)



instalation lenght / einbaulänge
max head / förderhöhe
connection size / nennweite **DN**
circulating pump / Umwälzpumpe

Pump markings / Typenschlüssel

E GHN D L 40 - 100 F

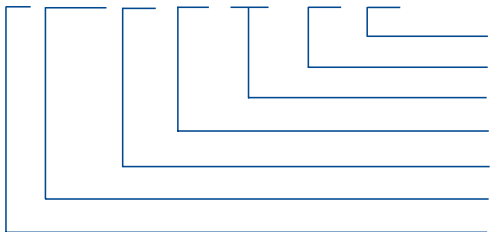

connection type - **F**lange / Rohranschluss - Flansche
max head / förderhöhe
connection size / nennweite **DN**
separated frequency inverter / abwickelbar Frequenzumformer
twin pump - **D** / zwillingsbauform- **D**
pump type / pumpentyp
electronic controlled / Elektronisch geregelt

Permitted mounting positions / Einbaumöglichkeiten



EGHN

EGHN-D



EGHN-L

EGHN-D-L



Variable speed circulating pumps Elektronisch geregelte Heizungsumwälzpumpen

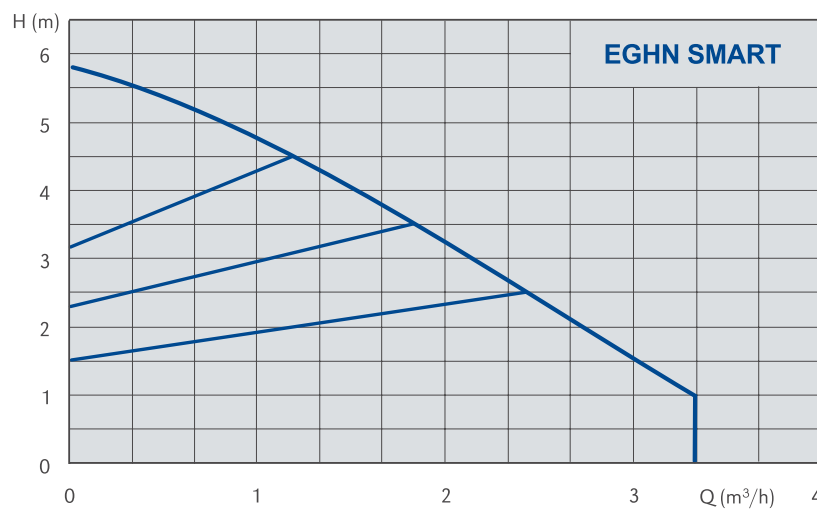
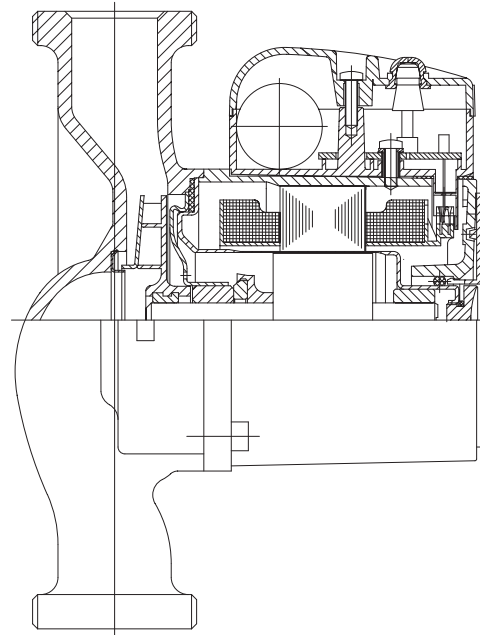

Circulating pumps with integrated frequency converter
Heizungsumwälzpumpen mit stufenloser Differenzdruckregelung - eingebauten Frequenzumformer

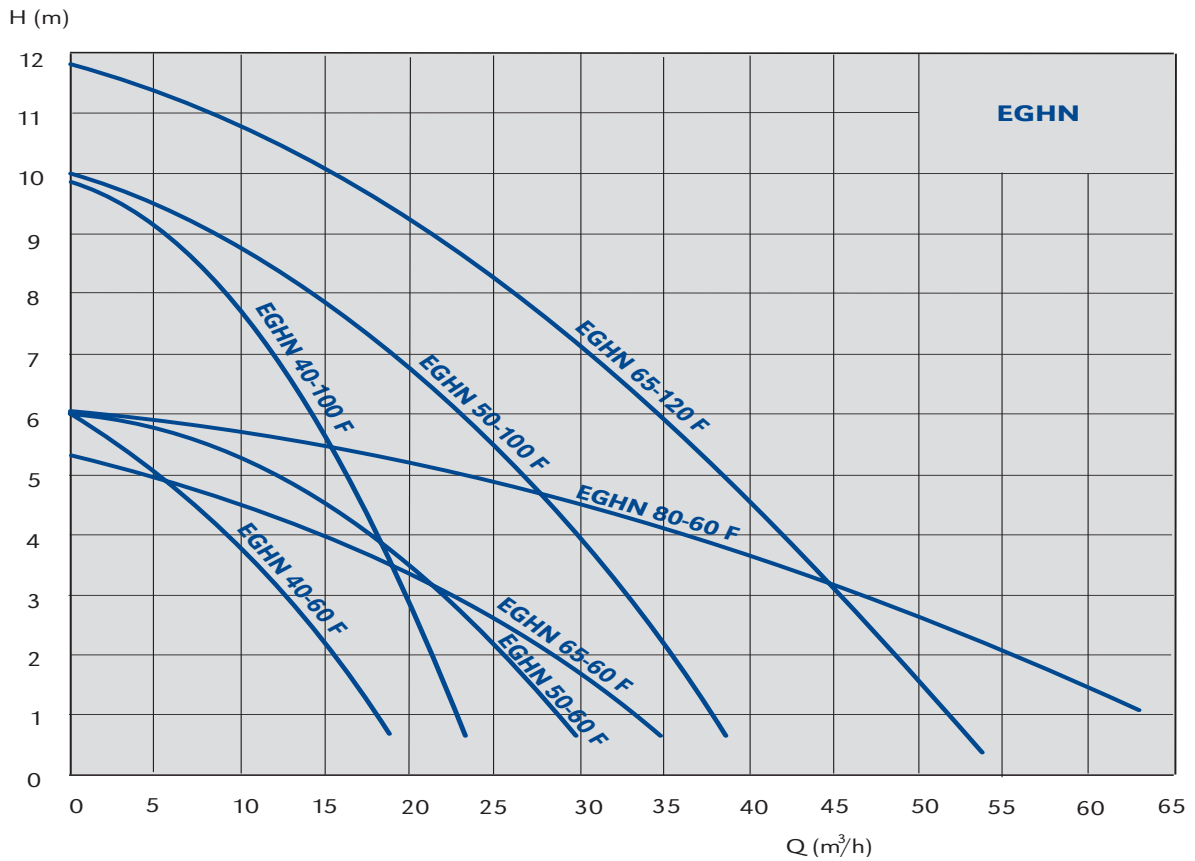
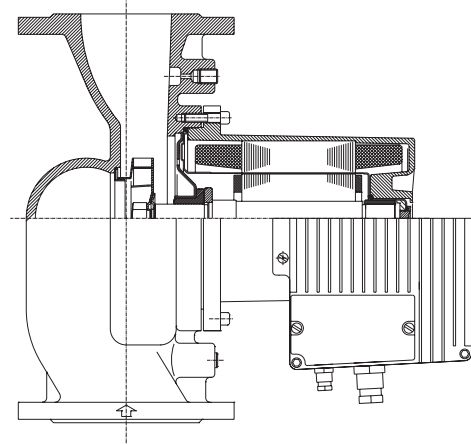

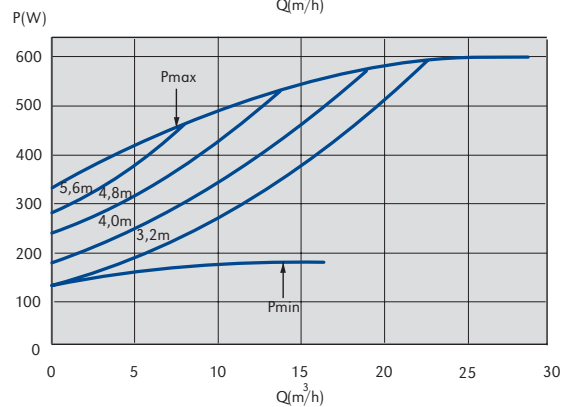
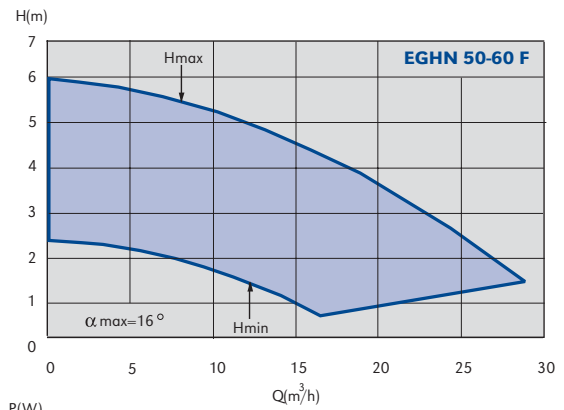
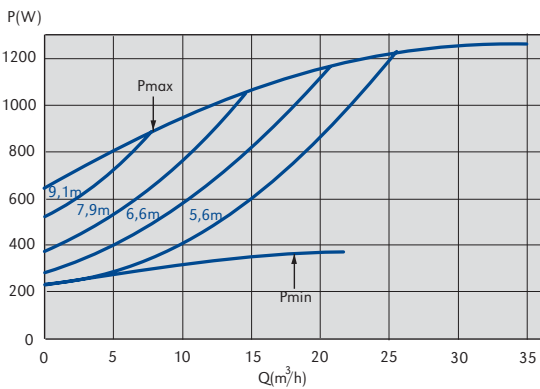
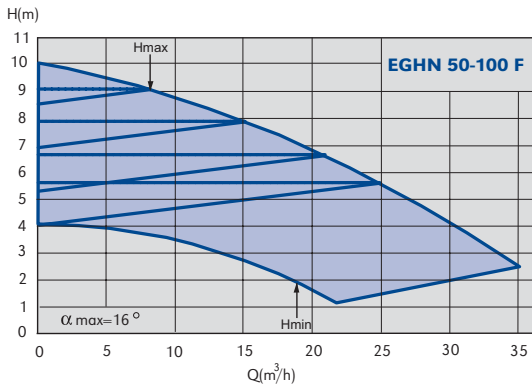
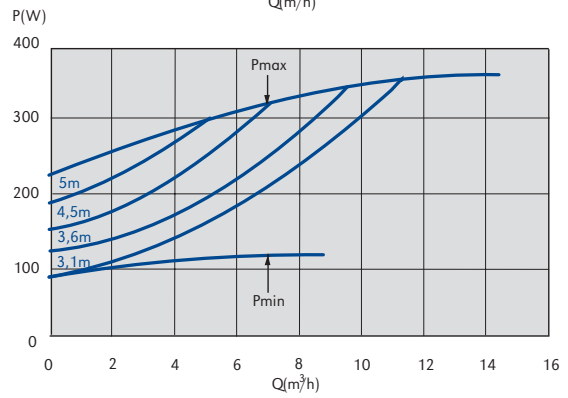
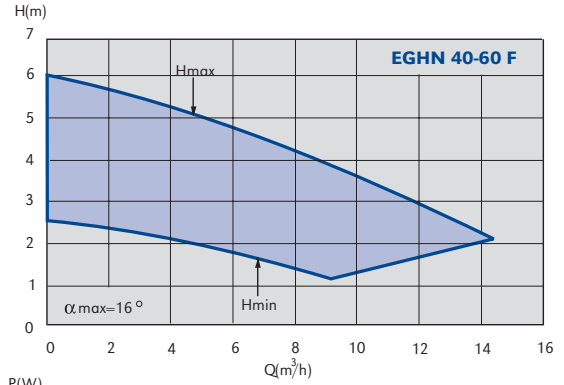
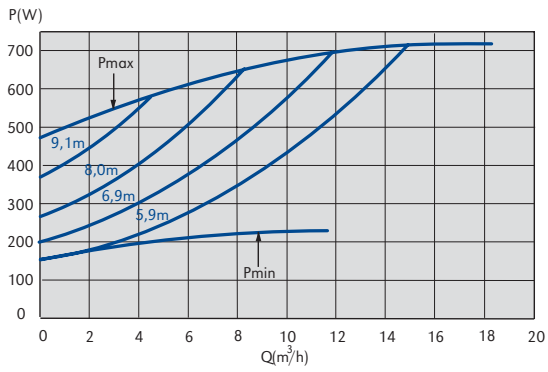
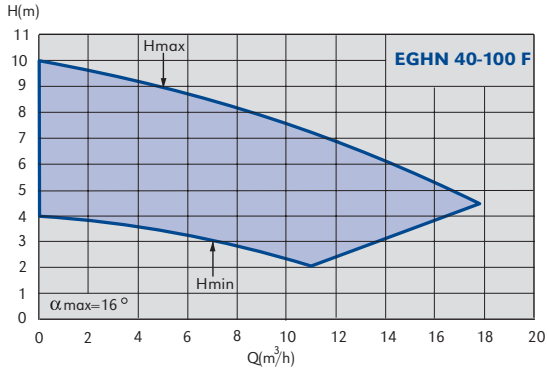

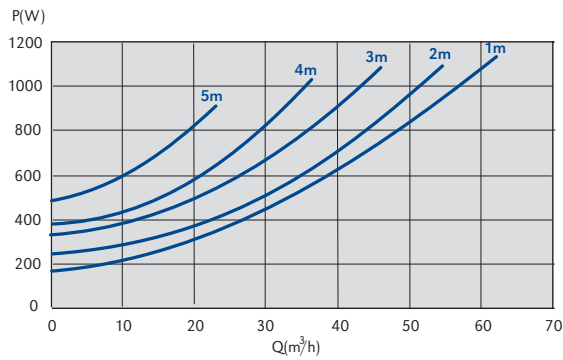
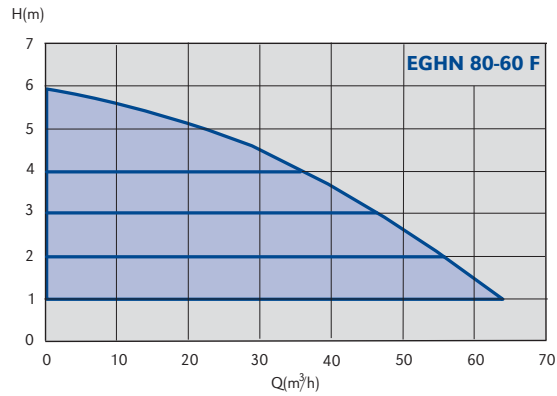
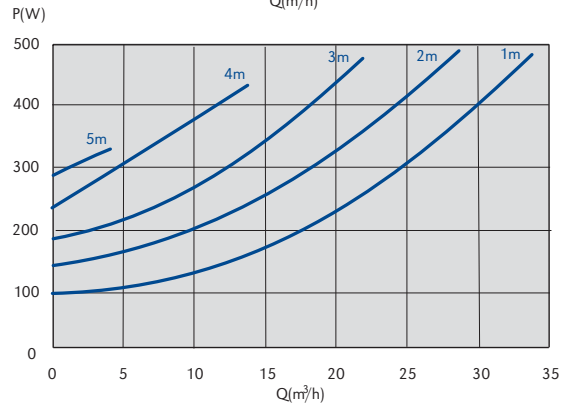
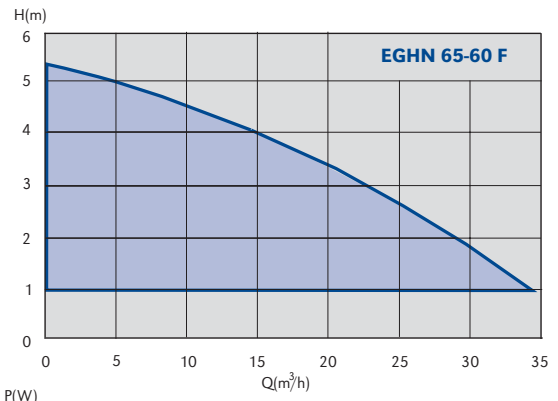
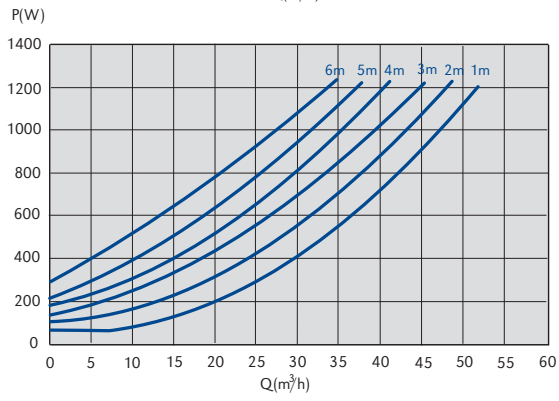
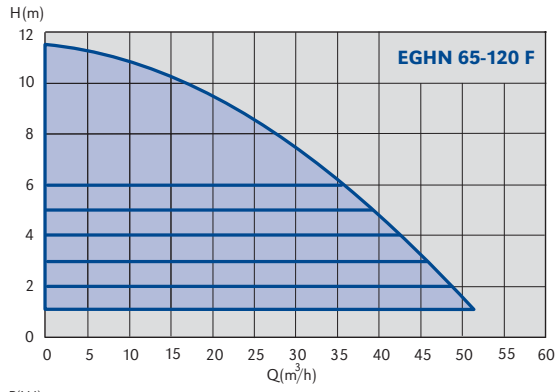

Twin circulating pumps with integrated frequency converter
Zwillingsumwälzpumpen mit stufenloser Differenzdruckregelung -
eingebauten Frequenzumformer

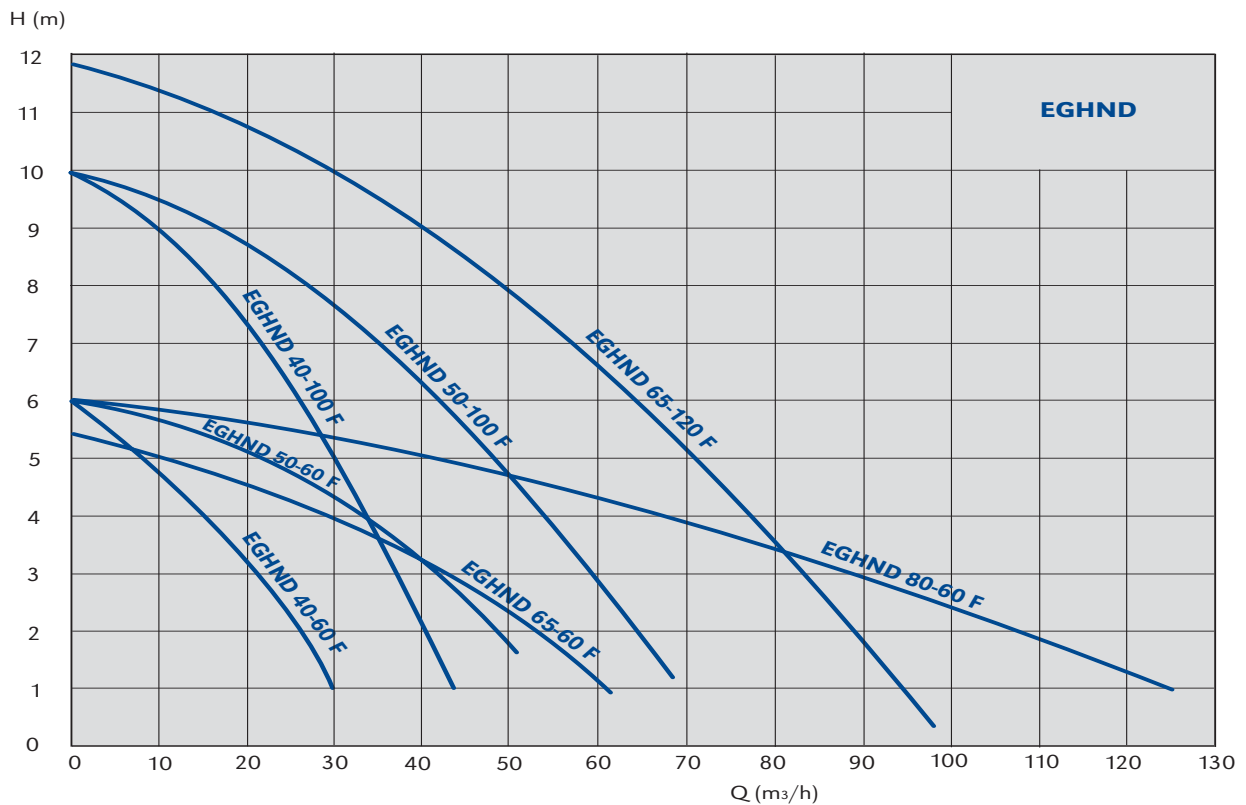
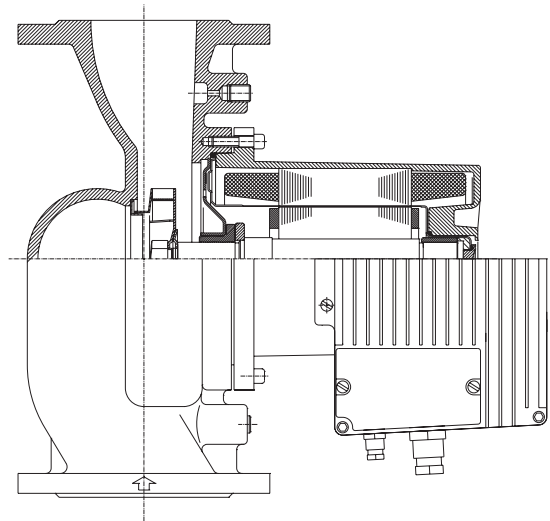

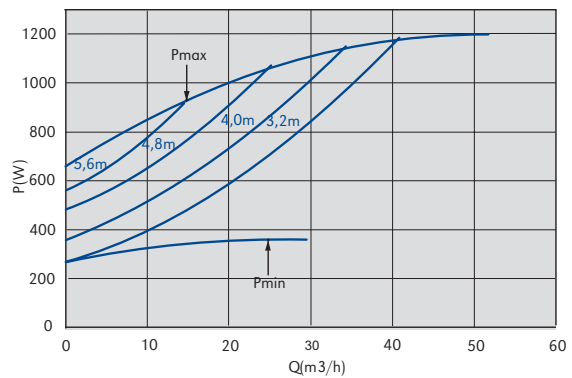
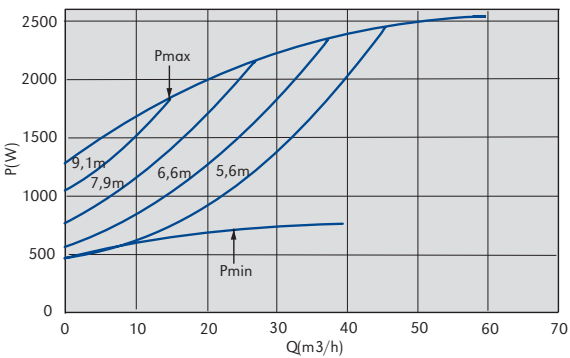
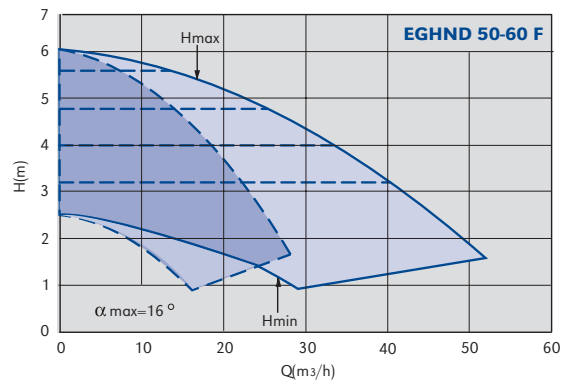
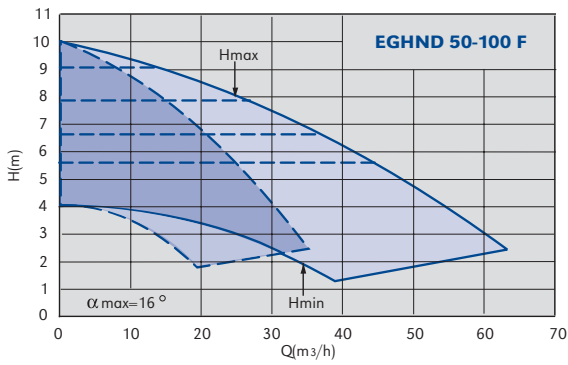
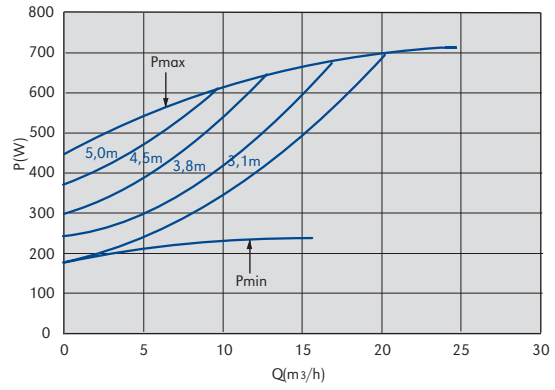
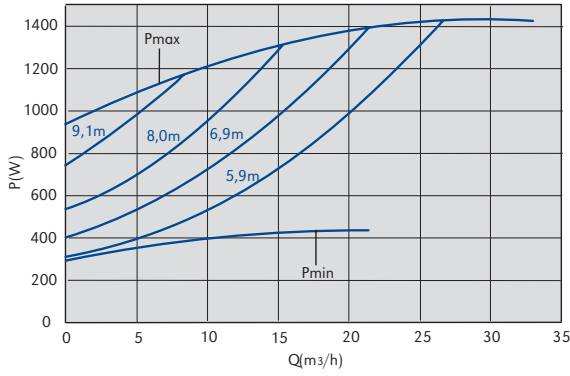
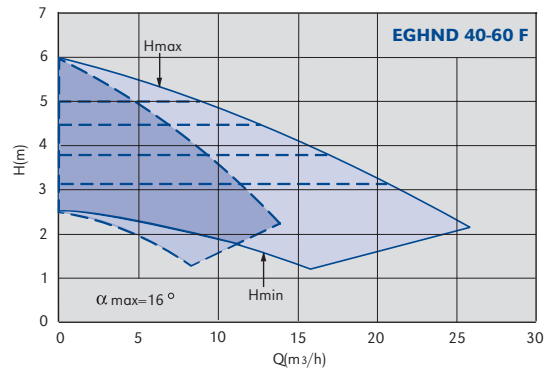
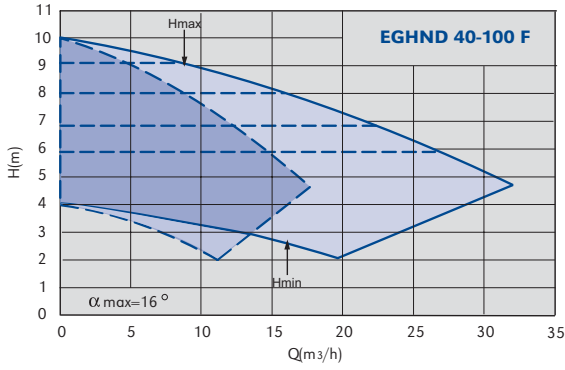

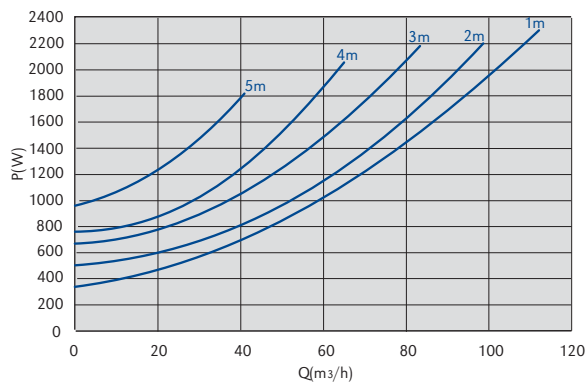
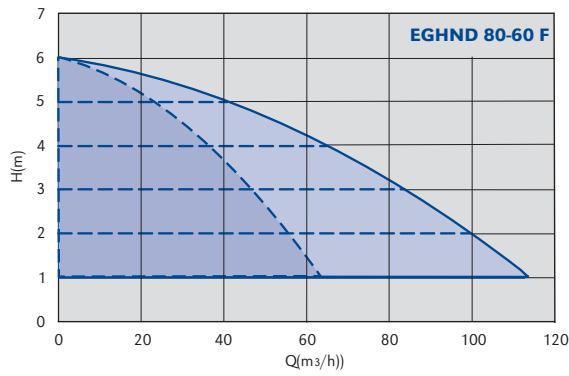
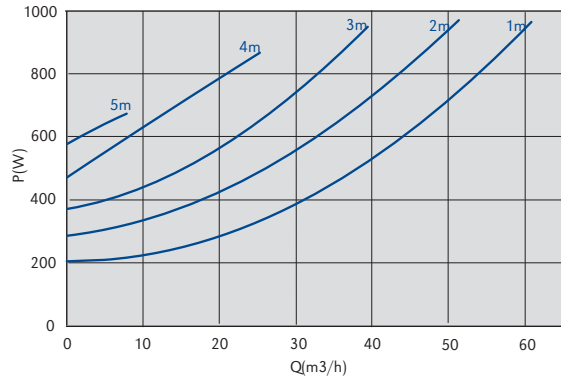
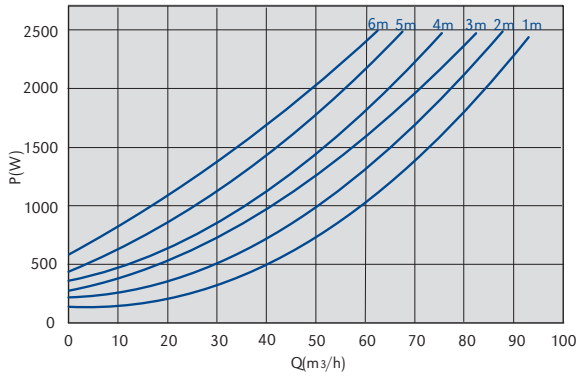
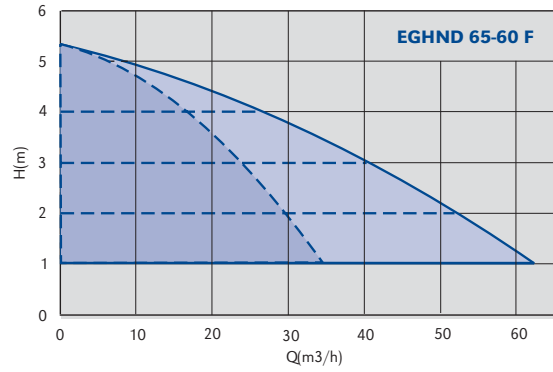
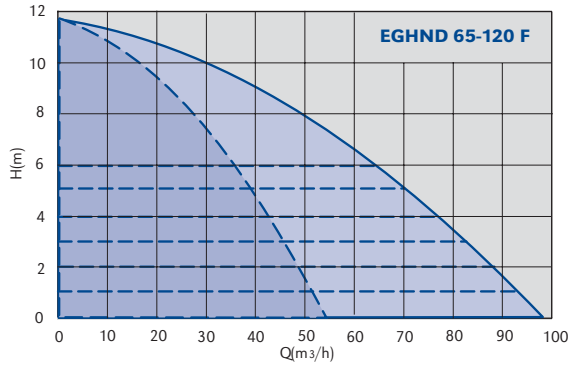

Circulating pumps with separated frequency converter
Heizungsumwälzpumpen mit stufenloser Differenzdruckregelung -
abwickelbar Frequenzumformer

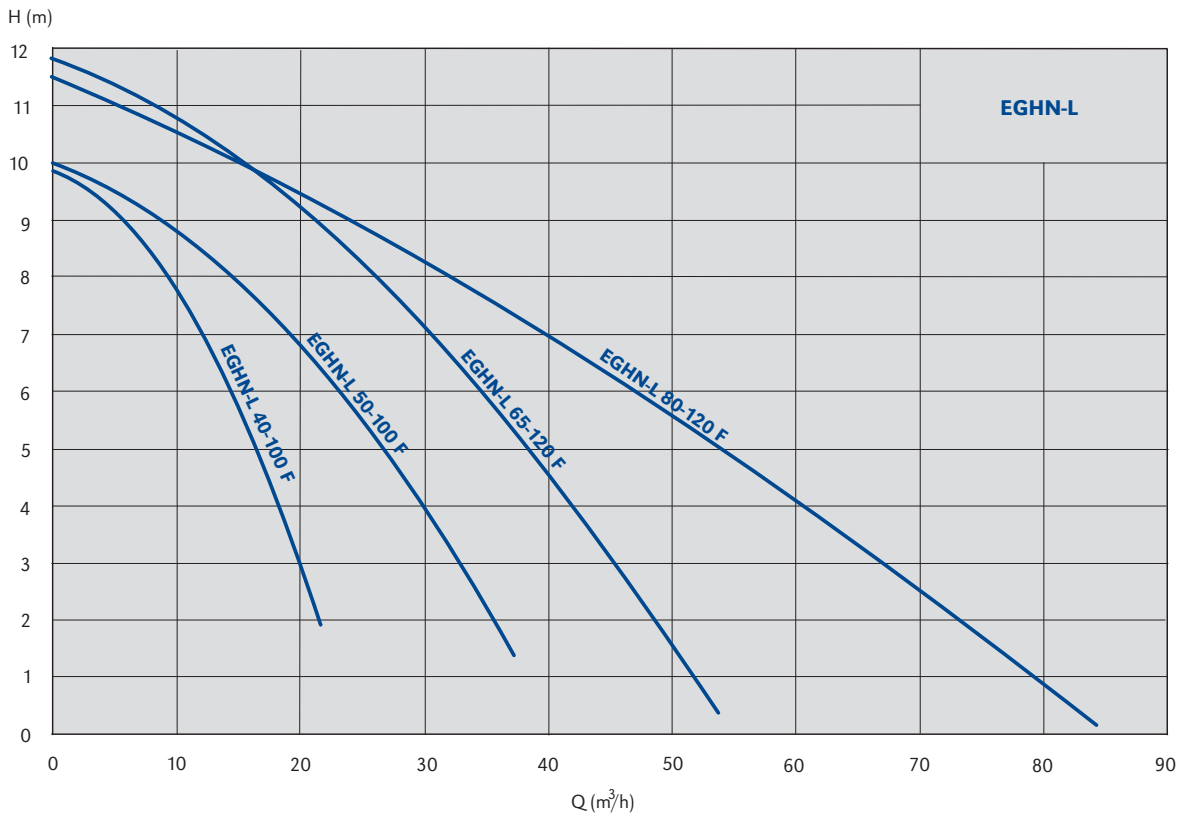
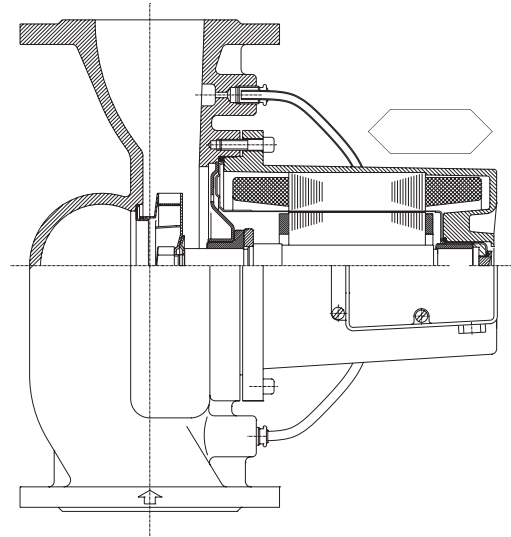
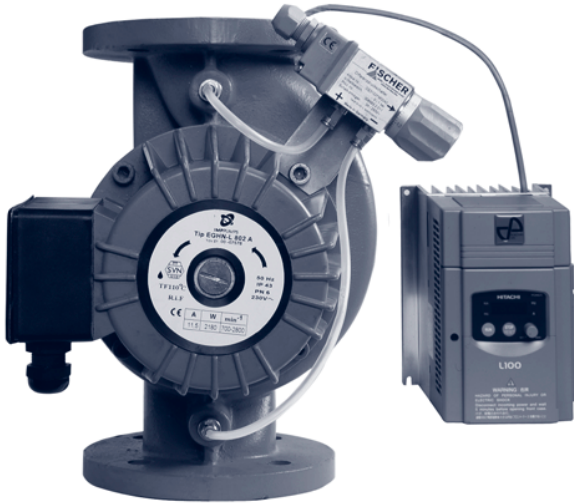

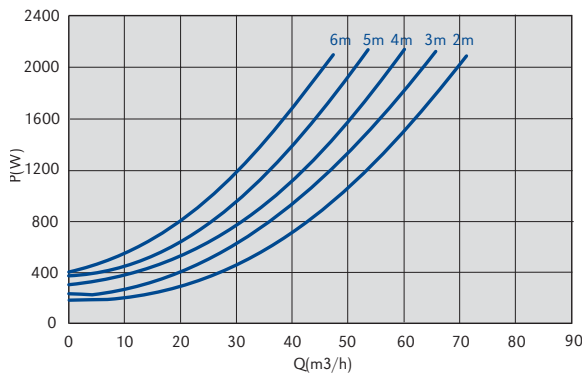
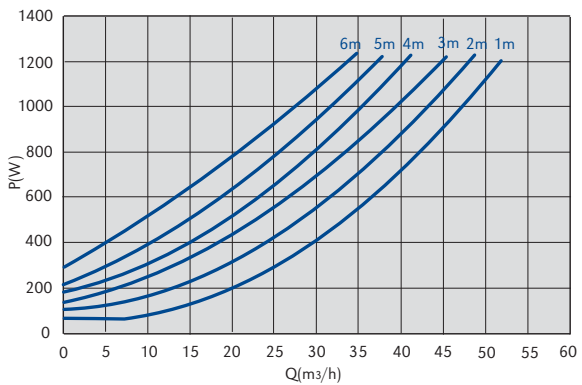
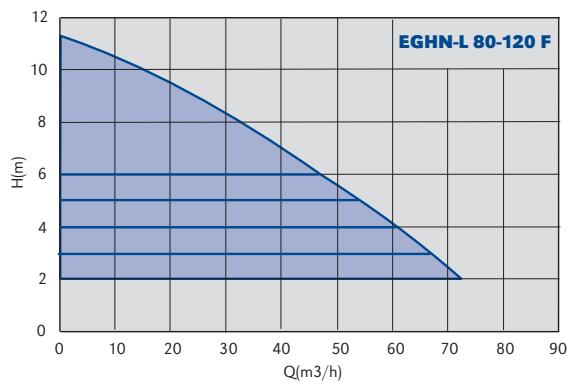
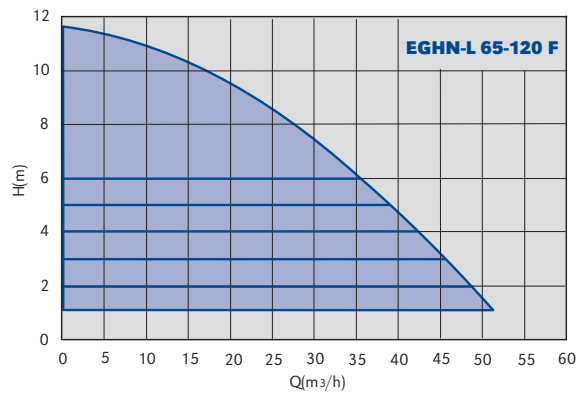
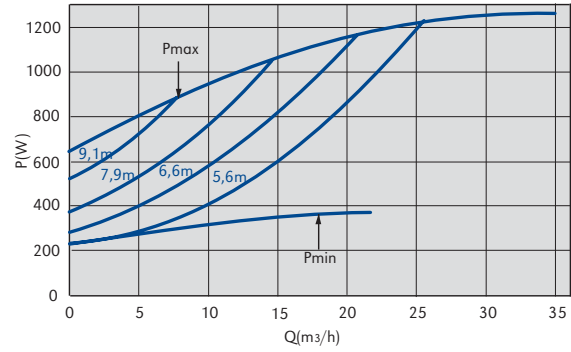
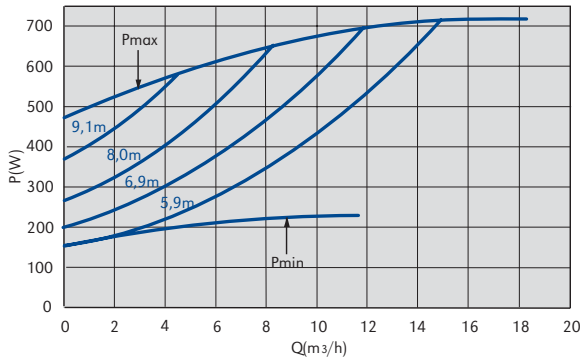
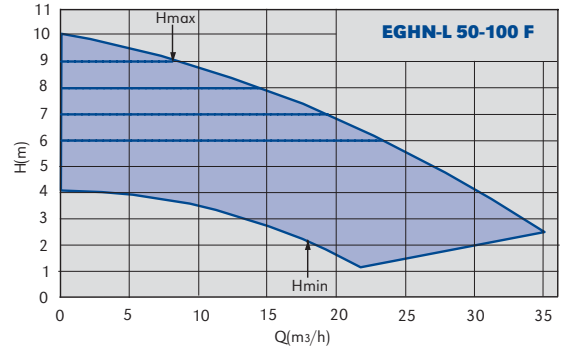
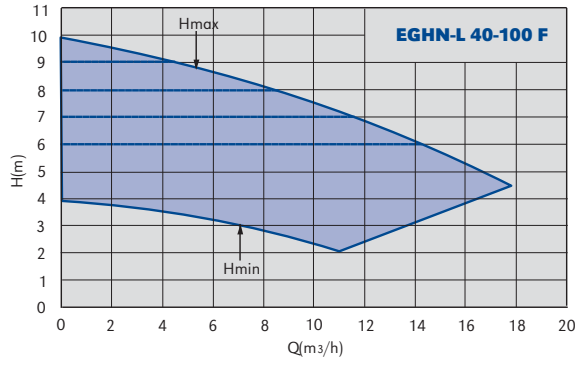

Twin circulating pumps with separated frequency converter
Zwillingsumwälzpumpen mit stufenloser Differenzdruckregelung -
abwickelbar Frequenzumformer

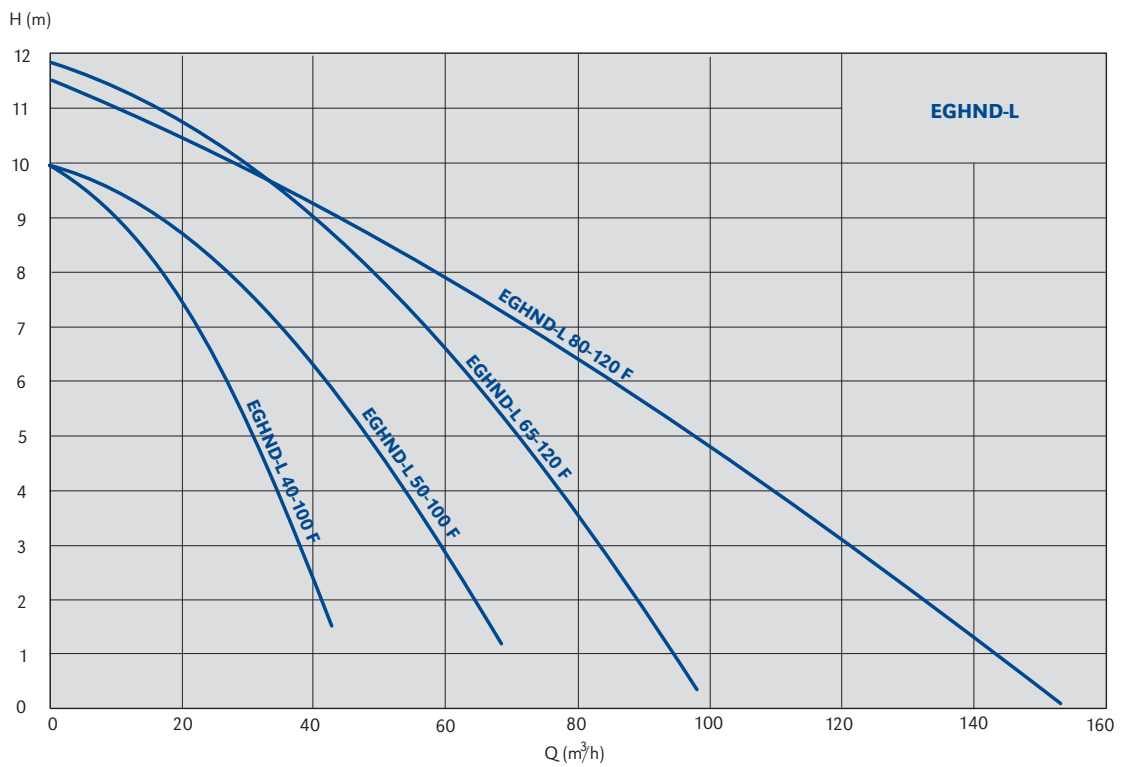
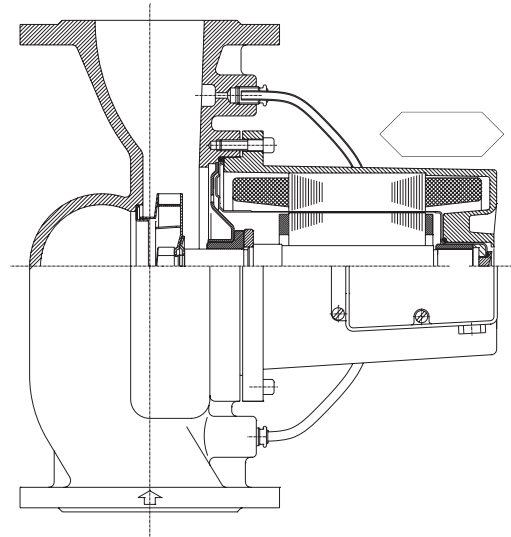
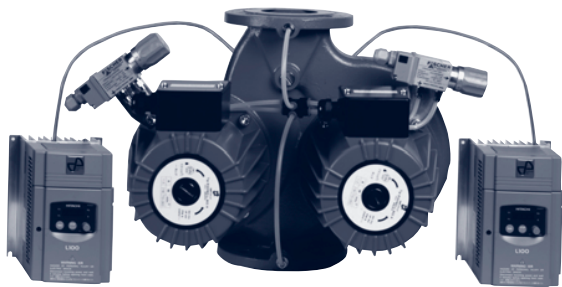

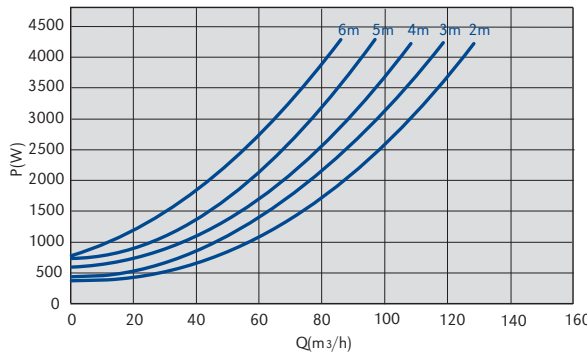
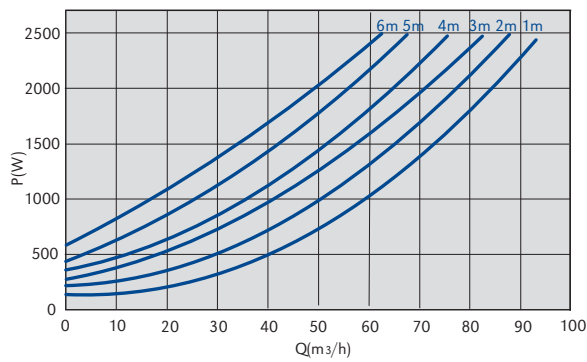
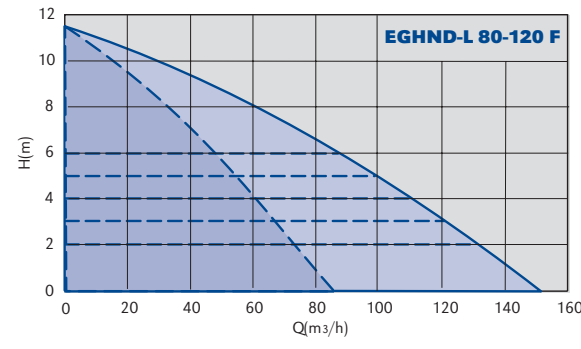
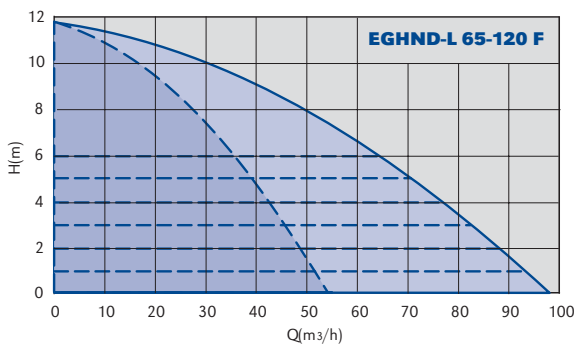
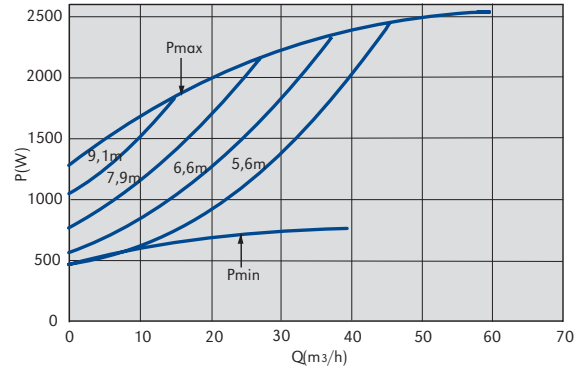
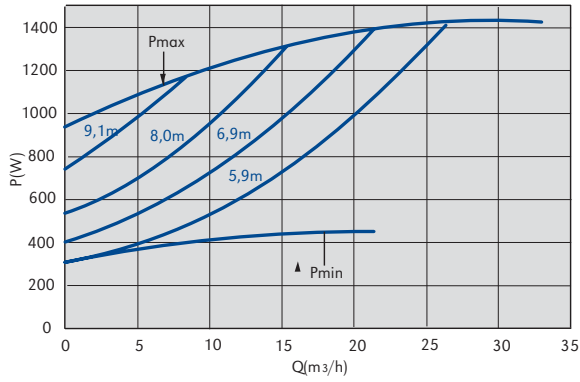
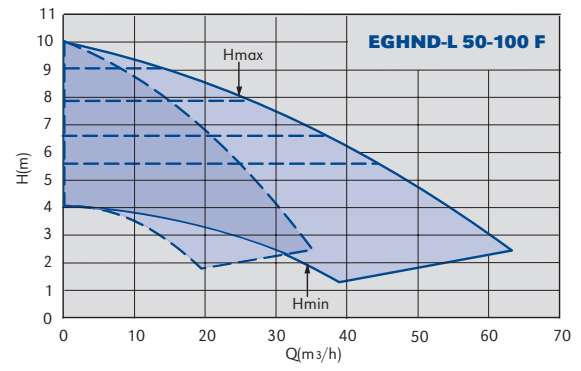
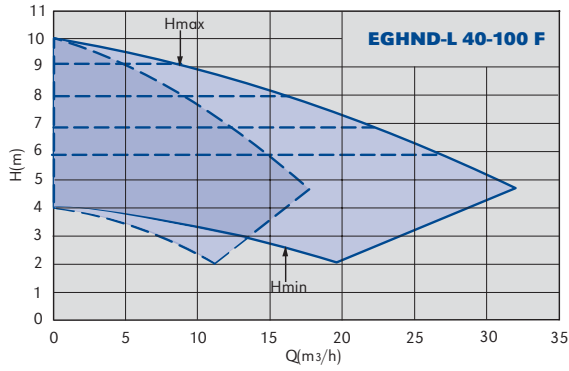

TEHNICAL DATA / TECHNISCHE DATEN

pump type pumpentyp	code artikel- nummer	connection type rohranschluss	max. flow durchfluss Q (m ³ /h)	max. head Förderhöhe druck H (m)	system pressure systemdruck PN (bar)	min. - max. media temperature temp. des medius Tmin-Tmax (°C)	casing type werkstoffe GG / Cast iron	single-S double-D einzelne-E zwillings- bauform-Z	weight gewicht (kg)	regulation geregelt yes /ja no /nein	degree of protection schutzart IP
EGHN SMART 15/60-130	979521965	Screw/gewinde	3,5	6	PN 10	5 - 84	GG/CI	S / E	2,4	yes/ja	44
EGHN SMART 20/60-130	979521966	Screw/gewinde	3,5	6	PN 10	5 - 84	GG/CI	S / E	2,4	yes/ja	44
EGHN SMART 25/60-130	979521967	Screw/gewinde	3,5	6	PN 10	5 - 84	GG/CI	S / E	2,4	yes/ja	44
EGHN SMART 20/60-180	979521968	Screw/gewinde	3,5	6	PN 10	5 - 84	GG/CI	S / E	2,6	yes/ja	44
EGHN SMART 25/60-180	979521969	Screw/gewinde	3,5	6	PN 10	5 - 84	GG/CI	S / E	2,6	yes/ja	44
EGHN SMART 32/60-180	979521970	Screw/gewinde	3,5	6	PN 10	5 - 84	GG/CI	S / E	3	yes/ja	44
EGHN 40-100 F	979521411	Flanges/Flansche	18	10	PN 6 / 10	15 - 110	GG/CI	S / E	24	yes/ja	43
EGHN 40-60 F	979521500	Flanges/Flansche	14	6	PN 6 / 10	15 - 110	GG/CI	S / E	24	yes/ja	43
EGHN 50-100 F	979521501	Flanges/Flansche	35	10	PN 6 / 10	15 - 110	GG/CI	S / E	34	yes/ja	43
EGHN 50-60 F	979521502	Flanges/Flansche	28	6	PN 6 / 10	15 - 110	GG/CI	S / E	34	yes/ja	43
EGHN 65-120F	979521503	Flanges/Flansche	50	11	PN 6 / 10	15 - 110	GG/CI	S / E	36	yes/ja	43
EGHN 65-60 F	979521504	Flanges/Flansche	34	5,5	PN 6 / 10	15 - 110	GG/CI	S / E	36	yes/ja	43
EGHN 80-60 F	979521506	Flanges/Flansche	63	6	PN 6	15 - 110	GG/CI	S / E	41	yes/ja	43
EGHN 80-60 F		Flanges/Flansche	63	6	PN 10	15 - 110	GG/CI	S / E	41	yes/ja	43
EGHND 40-100 F	979521540	Flanges/Flansche	32	10	PN 6 / 10	15 - 110	GG/CI	D / Z	40	yes/ja	43
EGHND 40-60 F	979521541	Flanges/Flansche	26	6	PN 6 / 10	15 - 110	GG/CI	D / Z	38	yes/ja	43
EGHND 50-100 F	979521542	Flanges/Flansche	63	10	PN 6 / 10	15 - 110	GG/CI	D / Z	49	yes/ja	43
EGHND 50-60 F	979521543	Flanges/Flansche	52	6	PN 6 / 10	15 - 110	GG/CI	D / Z	49	yes/ja	43
EGHND 65-120 F	979521544	Flanges/Flansche	98	11	PN 6 / 10	15 - 110	GG/CI	D / Z	59	yes/ja	43
EGHND 65-60 F	979521545	Flanges/Flansche	62	5,5	PN 6 / 10	15 - 110	GG/CI	D / Z	54	yes/ja	43
EGHND 80-60 F	979521546	Flanges/Flansche	115	6	PN 6	15 - 110	GG/CI	D / Z	67	yes/ja	43
EGHN - L 40-100 F	979521533	Flanges/Flansche	18	10	PN 6 / 10	-5 - +110	GG/CI	S / E	26	yes/ja	43
EGHN - L 50-100 F	979521534	Flanges/Flansche	35	10	PN 6 / 10	-5 - +110	GG/CI	S / E	37	yes/ja	43
EGHN - L 65-120 F	979521535	Flanges/Flansche	50	11	PN 6 / 10	-5 - +110	GG/CI	S / E	39	yes/ja	43
EGHN - L 80-120 F	979521505	Flanges/Flansche	70	11	PN 6	-5 - +110	GG/CI	S / E	45	yes/ja	43
EGHN - L 80-120 F	979521550	Flanges/Flansche	70	11	PN 10	-5 - +110	GG/CI	S / E	45	yes/ja	43
EGHND - L 40-100 F	979521536	Flanges/Flansche	32	10	PN 6 / 10	-5 - +110	GG/CI	D / Z	41	yes/ja	43
EGHND - L 50-100 F	979521537	Flanges/Flansche	62	10	PN 6 / 10	-5 - +110	GG/CI	D / Z	50	yes/ja	43
EGHND - L 65-120 F	979521538	Flanges/Flansche	98	11	PN 6 / 10	-5 - +110	GG/CI	D / Z	61	yes/ja	43
EGHND - L 80-120 F	979521539	Flanges/Flansche	150	11	PN 6	-5 - +110	GG/CI	D / Z	68	yes/ja	43

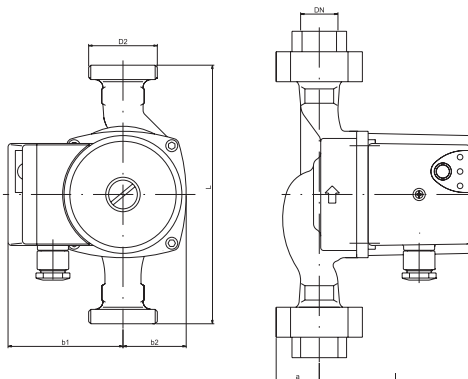





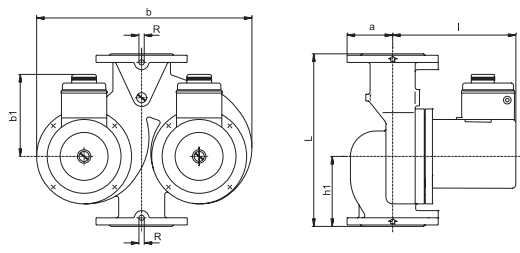
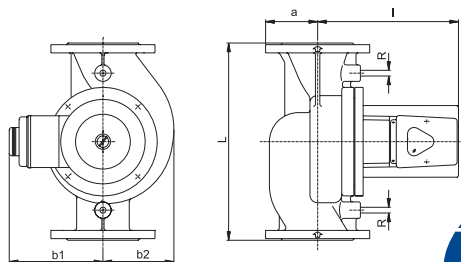
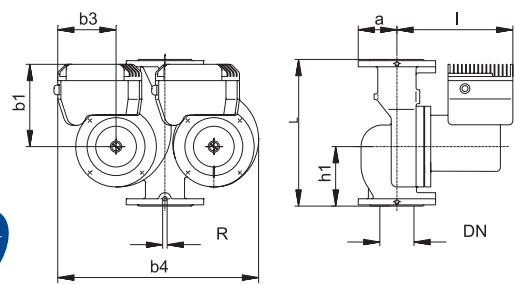
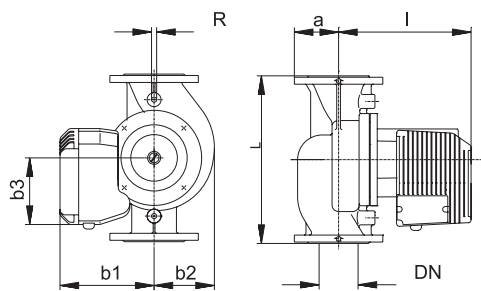

























DIMENSIONS / MAßE

	pump type pumpentyp	code artikel- nummer	length einbaulänge L (mm)	connection size rohranschluss DN	b1	b2	b3	b4	l	h1	a	R	D2	D3	D4	D5	no. hole
0	EGHN SMART 15/60-130	979521965	130	DN 15	80	44			108		28		1"				
	EGHN SMART 20/60-130	979521966	130	DN 20	80	44			108		28		5/4"				
	EGHN SMART 25/60-130	979521967	130	DN 25	80	44			108		28		6/4"				
	EGHN SMART 20/60-180	979521968	180	DN 20	80	44			108		28		5/4"				
	EGHN SMART 25/60-180	979521969	180	DN 25	80	44			108		28		6/4"				
1	EGHN SMART 32/60-180	979521970	180	DN 32	80	44			108		30		2"				
	EGHN 40-100 F	979521411	250	DN 40	200	92	148		247		65	1/4"	80	100/110	150	14/19	4
	EGHN 40-60 F	979521500	250	DN 40	200	92	148		247		65	1/4"	80	100/110	150	14/19	4
	EGHN 50-100 F	979521501	280	DN 50	205	123	148		304		70	1/4"	102	110/125	165	14/19	4
	EGHN 50-60 F	979521502	280	DN 50	205	123	148		304		70	1/4"	102	110/125	165	14/19	4
	EGHN 65-120 F	979521503	340	DN 65	205	123	148		304		80	1/4"	122	130/145	185	14/19	4
	EGHN 65-60 F	979521504	340	DN 65	205	123	148		304		80	1/4"	122	130/145	185	14/19	4
	EGHN 80-60 F	979521506	380	DN 80	205	128	148		304		100	1/4"	158	170	220	19	4
2	EGHN 80-60 F		380	DN 80	205	128	148		304		100	1/4"	158	180	220	19	8
	EGHND 40-100 F	979521540	250	DN 40	200	92		417	247	110	65	1/4"	80	100/110	150	14/19	4
	EGHND 40-60 F	979521541	250	DN 40	200	92		417	247	110	65	1/4"	80	100/110	150	14/19	4
	EGHND 50-100 F	979521542	280	DN 50	205	123		457	304	121	70	1/4"	102	110/125	165	14/19	4
	EGHND 50-60 F	979521543	280	DN 50	205	123		457	304	121	70	1/4"	102	110/125	165	14/19	4
	EGHND 65-120 F	979521544	340	DN 65	205	123		501	304	141	80	1/4"	122	130/145	185	14/19	4
	EGHND 65-60 F	979521545	340	DN 65	205	123		501	304	141	80	1/4"	122	130/145	185	14/19	4
	EGHND 80-60 F	979521546	380	DN 80	205	128		506	304	146	100	1/4"	158	170	220	19	4
3	EGHN - L 40-100 F	979521533	250	DN 40	200	92	148		247		65	1/4"	80	100/110	150	14/19	4
	EGHN - L 50-100 F	979521534	280	DN 50	205	123	148		304		70	1/4"	102	110/125	165	14/19	4
	EGHN - L 65-120 F	979521535	340	DN 65	205	123	148		304		80	1/4"	122	130/145	185	14/19	4
	EGHN - L 80-120 F	979521505	380	DN 80	205	128	148		304		100	1/4"	158	170	220	19	4
4	EGHN - L 80-120 F	979521550	380	DN 80	205	128	148		304		100	1/4"	158	170	220	19	4
	EGHND - L 40-100 F	979521536	250	DN 40	200	92	148	417	247	110	65	1/4"	80	100/110	150	14/19	4
	EGHND - L 50-100 F	979521537	280	DN 50	205	123	148	457	304	121	70	1/4"	102	110/125	165	14/19	4
	EGHND - L 65-120 F	979521538	340	DN 65	205	123	148	501	304	141	80	1/4"	122	130/145	185	14/19	4
EGHND - L 80-120 F	979521539	380	DN 80	205	128	148	506	304	146	100	1/4"	158	170	220	19	4	



ELECTRICAL DATA / ELEKTRISCHE DATEN

MAX WORKING PRESSURE (bar)
MAX ZÜLASSIGER BETRIEBSDRUCK

pump type pumptyp	code artikelnummer	power max. leistungsaufnahme P (W)	speed range drehzahlstufe (min-1)	FLC I nennstrom I _n (A)	electrical voltage elektroanschluss I (V)	insulating class isoliationsklasse	temperature / temperatur		
							50°C	80°C	110°C
 EGHN SMART 15/60-130	979521965	84	1109-2340	0,17-0,3	230 V	H	0,05	0,4	1,1
 EGHN SMART 20/60-130	979521966	84	1109-2340	0,17-0,3	230 V	H	0,05	0,4	1,1
 EGHN SMART 25/60-130	979521967	84	1109-2340	0,17-0,3	230 V	H	0,05	0,4	1,1
 EGHN SMART 20/60-180	979521968	84	1109-2340	0,17-0,3	230 V	H	0,05	0,4	1,1
 EGHN SMART 25/60-180	979521969	84	1109-2340	0,17-0,3	230 V	H	0,05	0,4	1,1
 EGHN SMART 32/60-180	979521970	84	1109-2340	0,17-0,3	230 V	H	0,05	0,4	1,1
 EGHN 40-100 F	979521411	650	700 - 2800	5,6	230 V	H	0,05	0,8	1,4
 EGHN 40-60 F	979521500	330	700 - 2800	2,8	230 V	H	0,05	0,8	1,4
 EGHN 50-100 F	979521501	1180	700 - 2800	8,5	230 V	H	0,3	1	1,6
 EGHN 50-60 F	979521502	540	700 - 2800	4	230 V	H	0,3	1	1,6
 EGHN 65-120 F	979521503	1270	700 - 2800	8,9	230 V	H	0,3	1	1,6
 EGHN 65-60 F	979521504	450	700 - 2800	4	230 V	H	0,3	1	1,6
 EGHN 80-60 F	979521506	1090	700 - 2800	7	230 V	H	0,3	1	1,6
 EGHN 80- 60 F	ni kode	1090	700 - 2800	7	230 V	H	0,3	1	1,6
 EGHN-D 40-100 F	979521540	650	700 - 2800	5,6	230 V	H	0,05	0,8	1,4
 EGHN-D 40-60 F	979521541	330	700 - 2800	2,8	230 V	H	0,05	0,8	1,4
 EGHN-D 50-100 F	979521542	1180	700 - 2800	8,5	230 V	H	0,3	1	1,6
 EGHN-D 50-60 F	979521543	540	700 - 2800	4	230 V	H	0,3	1	1,6
 EGHN-D 65-120 F	979521544	1270	700 - 2800	8,9	230 V	H	0,3	1	1,6
 EGHN-D 65-60 F	979521545	450	700 - 2800	4	230 V	H	0,3	1	1,6
 EGHN-D 80-60 F	979521546	1090	700 - 2800	7	230 V	H	0,3	1	1,6
 EGHN - L 40-100 F	979521533	650	700 - 2800	5,6	230 V	H	0,05	0,8	1,4
 EGHN - L 50-100 F	979521534	1180	700 - 2800	8,5	230 V	H	0,3	1	1,6
 EGHN - L 65-120 F	979521535	1270	700 - 2800	8,9	230 V	H	0,3	1	1,6
 EGHN - L 80-120 F	979521505	2180	700 - 2800	13,4	230 V	H	0,3	1	1,6
 EGHN - L 80-120 F	979521550	2180	700 - 2800	13,4	230 V	H	0,3	1	1,6
 EGHN-D - L 40-100 F	979521536	650	700 - 2800	5,6	230 V	H	0,05	0,8	1,4
 EGHN-D - L 50-100 F	979521537	1180	700 - 2800	8,5	230 V	H	0,3	1	1,6
 EGHN-D - L 65-120 F	979521538	1270	700 - 2800	8,9	230 V	H	0,3	1	1,6
 EGHN-D - L 80-120 F	979521539	2180	700 - 2800	13,4	230 V	H	0,3	1	1,6

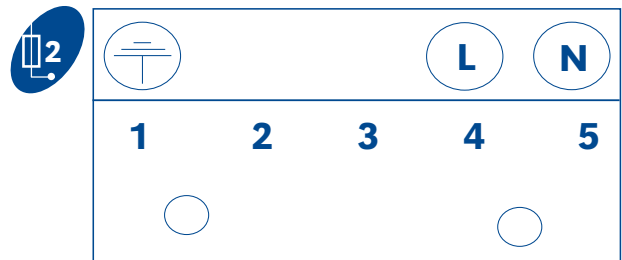
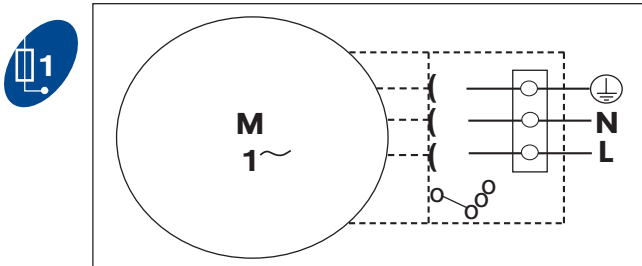

GHN / GHND / GHNM / GHNDM

GHN / GHND
GHNM / GHNMD

Three speeds circulating pumps
Dreistufige Heizungsumwälzpumpe



Three speeds circulating pumps Dreistufige Heizungsumwälzpumpe

TEHNICAL FEATURES / TECHNISCHE MERKMALE		GHN	GHN	GHND	GHND	GHNM	GHNMD
Connections / Nenweite	DN (")	15, 20, 25, 32	40 - 80	32	40 - 80	40 - 80	40 - 80
Connection type / Rohranschluss		Screw Type/Gewind	Flanges / Flansche	Screw Type/Gewind	Flanges / Flansche	Flanges / Flansche	Flanges / Flansche
Flow max / Förderstrom max	Q (m ³ /h)	3/4/6/8/9/13	80	10,8/14,4/14,3	140	22	40
Head max / Förderhöhe	H (m)	4/6/7/7,5/8	12	6,4/7,3/10,8	12	11,5	11,5
Pressure rated / Betriebsdruck	PN (bar)	10	6 / 10	10	6 / 10	6 / 10	6 / 10
Power max / Leistungsaufnahme max	P (W)	50/90/140/210/260	2200	270/393/509	2200	830	830
Electrical voltage / Elektroanschluss	V	1 x 230 AC	3 x 400 AC	1 x 230 AC	3 x 400 AC	1 x 230 AC	1 x 230 AC
Degree of protection / Schutzart	IP	44	43	44	43	43/44	43
Regulation / Regelung		no / nein	no / nein	no / nein	no / nein	no / nein	no / nein
Media temperature / Temperaturbereich	T(°C)	-10 do +110	-10 do +120	-10 do +110	-10 do +120	-10 do +120	-10 do +120
Insulating class / Isolationsklasse		H	H	H	H	H	H
Casing type / Werkstoffe		GG / Cast iron	GG / Cast iron	GG / Cast iron	GG / Cast iron	GG / Cast iron	GG / Cast iron
Duble pump / Zwillingspumpe		no / nein	no / nein	yes / ja	yes / ja	no / nein	no / nein
APPLICATIONS / EINSATZGEBIETE							
Heating / Warmwasserheizungen		✓	✓	✓	✓	✓	✓
Cooling / Kaltwasseranlagen		✓	✓	✓	✓	✓	✓
Sanitary water / Brauchwasser							
Climate appliances / Klimaanlage		✓	✓	✓	✓	✓	✓
Industry / Industrieanlagen		✓	✓	✓	✓	✓	✓
Process technique / Verfahrenstechnik							
Condensation / Kondensat							
Salt water / Meerwasser							

Pump markings / Typenschlüssel

GHN 25 / 60 - 130 (180)

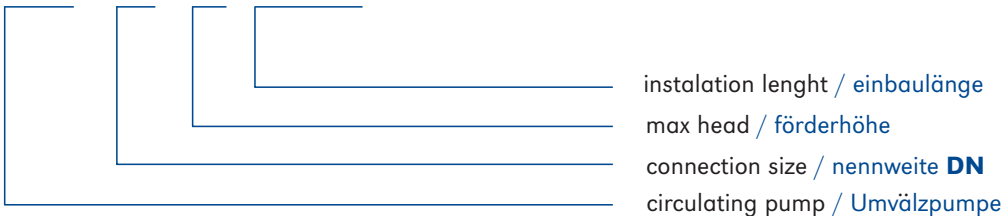

GHN M D 40 - 120 F

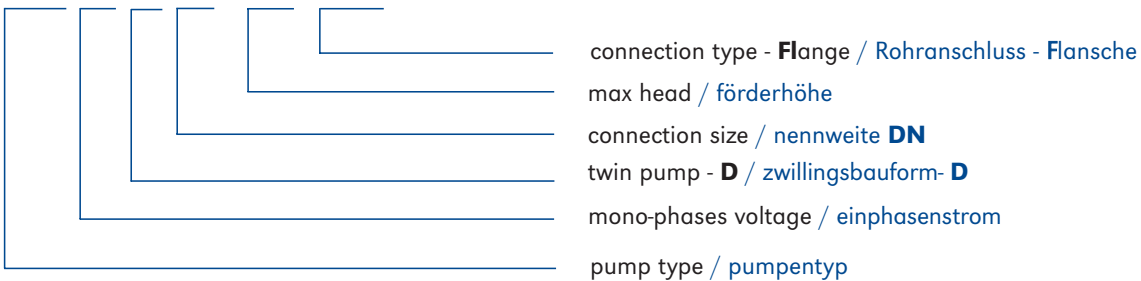

Permitted mounting positions / Einbaumöglichkeiten



Threaded circulation pumps with three speeds
Dreistufige Verschraubungsumwälzpumpen mit manueller Drehzahlumschaltung

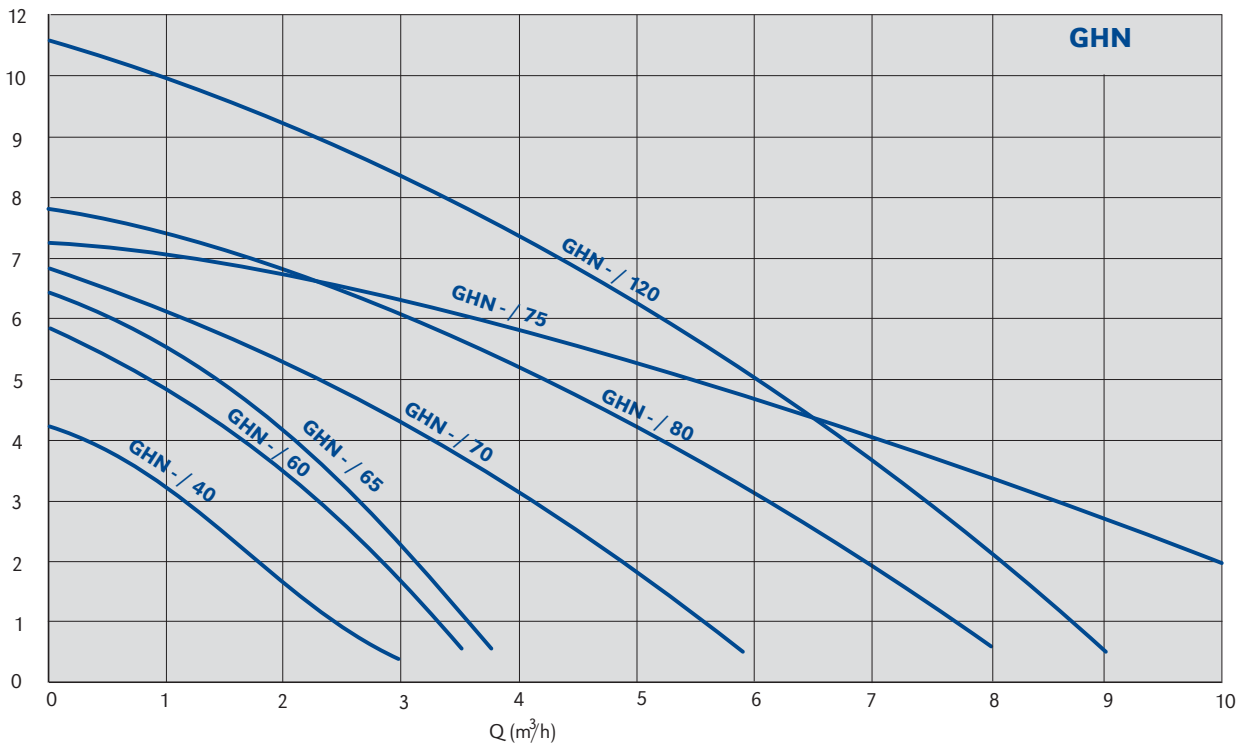
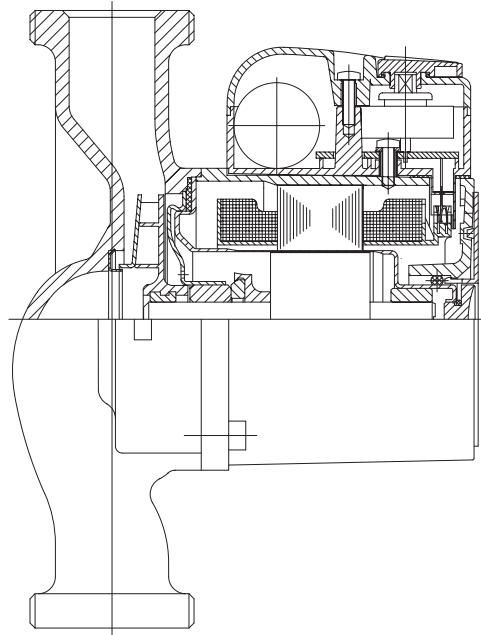

Threaded circulation pumps with three speeds
Dreistufige Verschraubungsumwälzpumpen mit manueller Drehzahlumschaltung

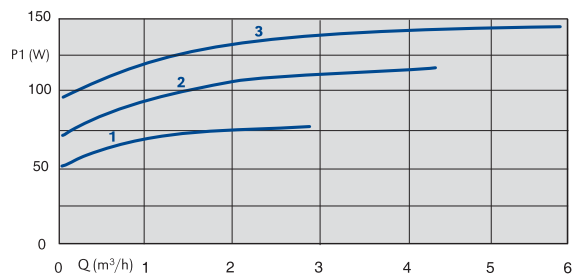
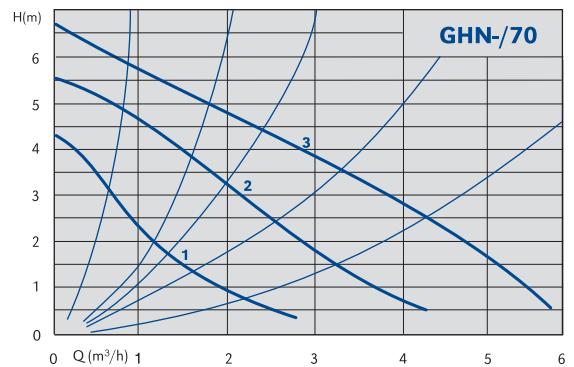
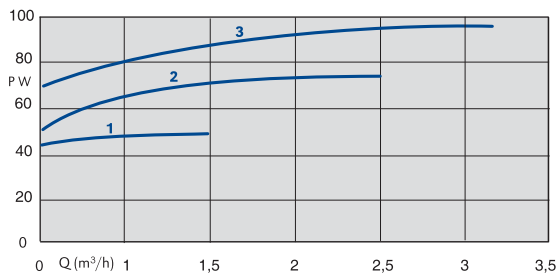
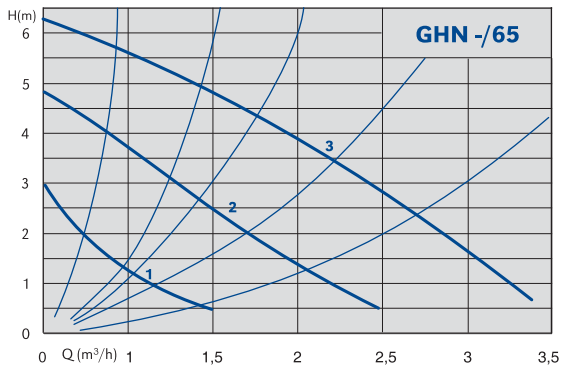
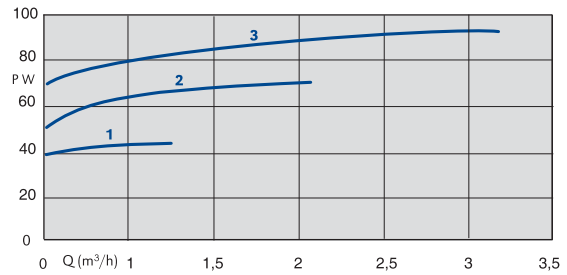
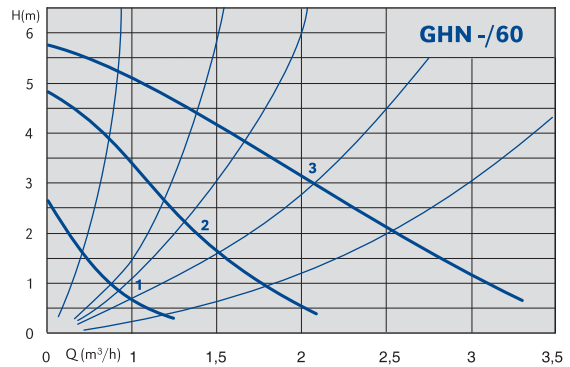
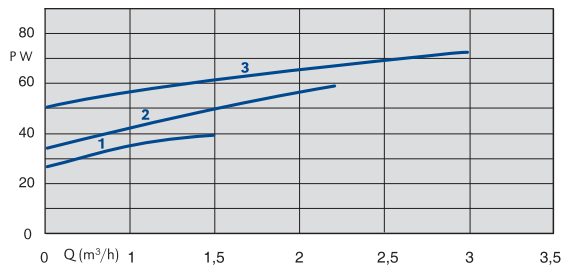
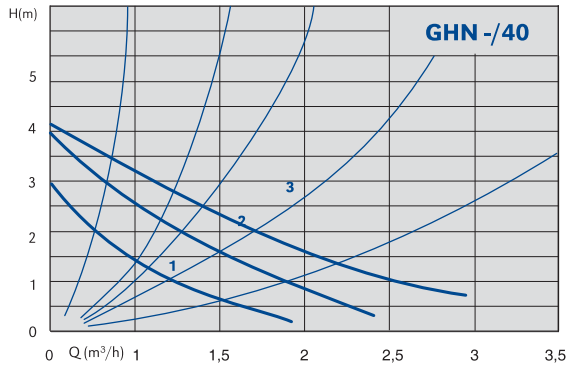

Threaded circulation pumps with three speeds Dreistufige Verschraubungsumwälzpumpen mit manueller Drehzahlumschaltung

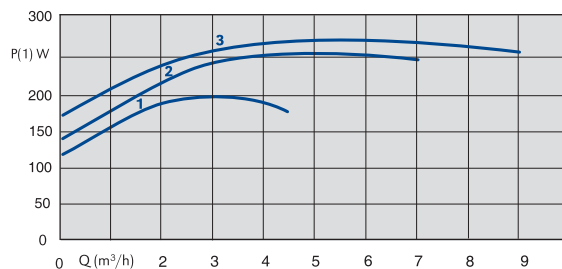
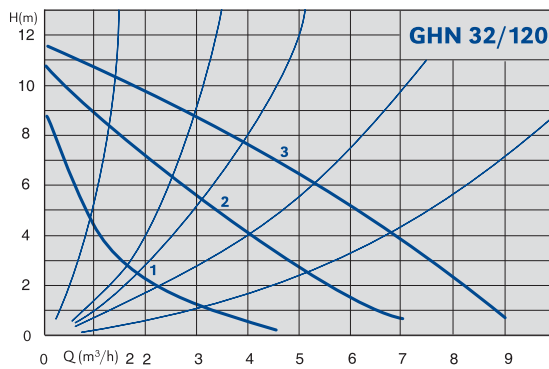
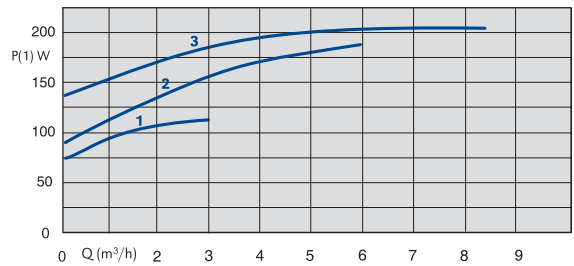
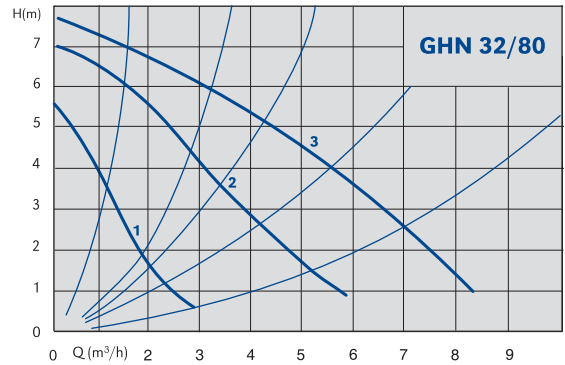
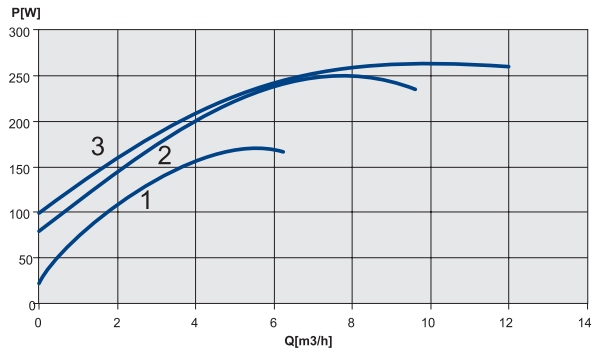
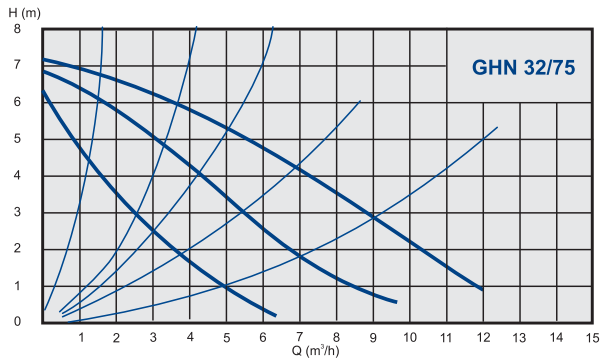
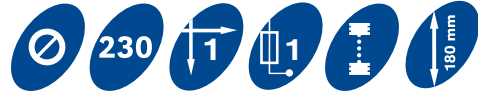

Threaded twin circulation pumps with three speeds
Dreistufige Zwillings Verschraubungsumwälzpumpen mit manueller Drehzahlumschaltung

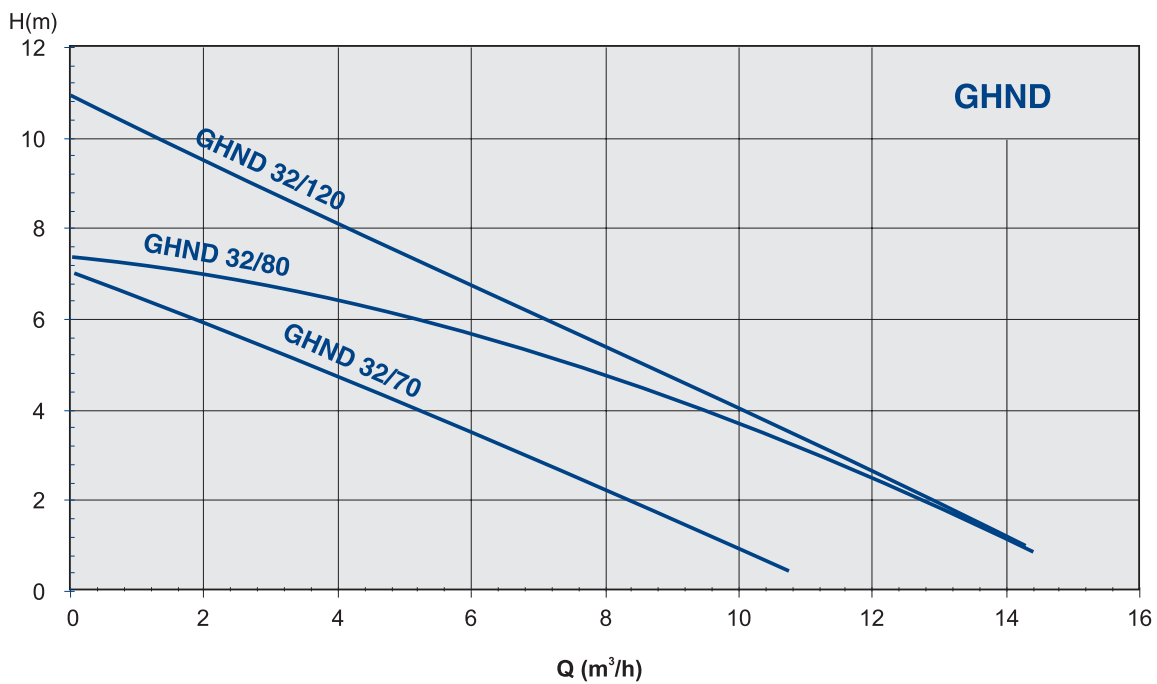
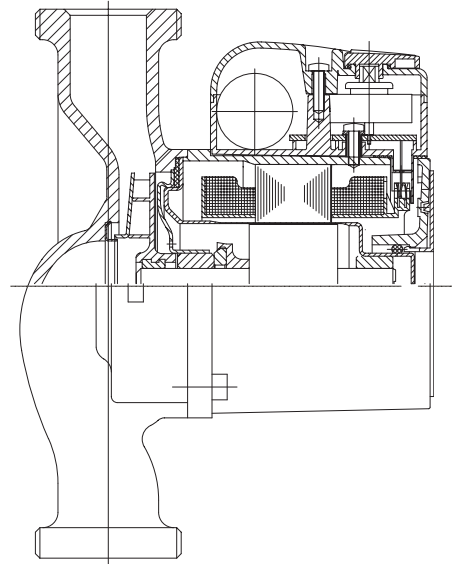

Threaded circulation pumps with three speeds Dreistufige Verschraubungsumwälzpumpen mit manueller Drehzahlumschaltung

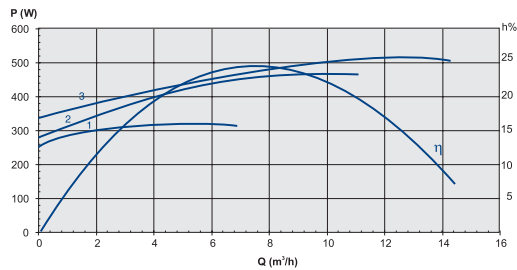
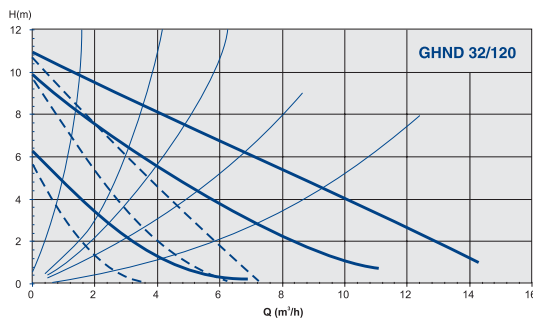
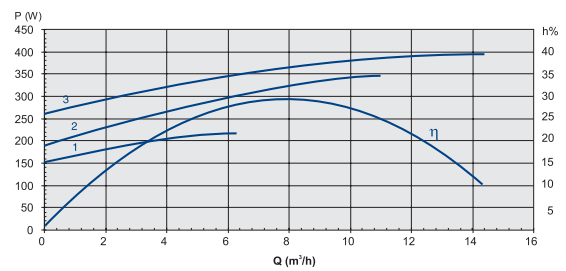
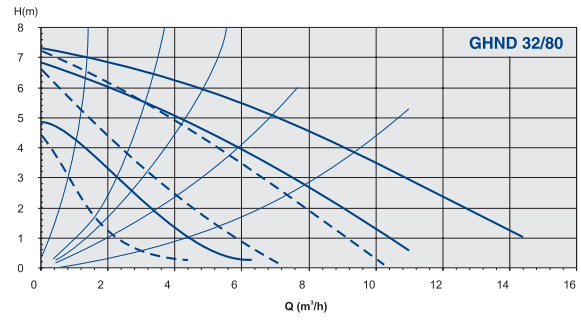
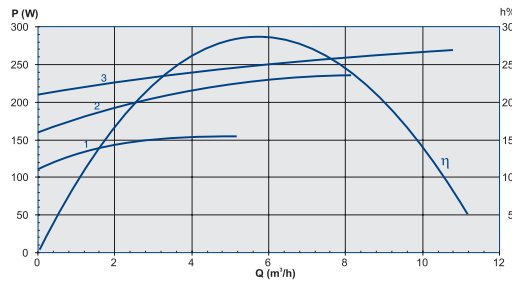
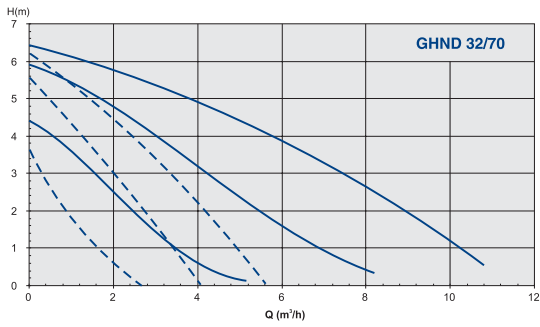
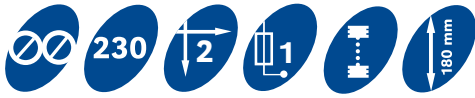

Threaded circulation pumps with three speeds Dreistufige Verschraubungsumwälzpumpen mit manueller Drehzahlumschaltung

ADVANTAGES OF SMALL PUMPS FROM IMP PUMPS

Reliable operation and long lifespan

Endurance and durability trials show the new generation of circulation pumps for home central heating systems are reliable under various operating conditions. The top quality materials used in making parts provide the pumps with a long lifespan.

Silent operation

The silent operation of the pumps is the result of careful development and advanced technical solutions in designing parts.

Adaptability of pumps to the heating system

A three-way switch provides a choice of pump power and optimal adaption to heating system requirements.

All installation material is provided

To save you time and unnecessary searching for installation material, we supply quality seals and fittings with all pumps in our family of small home pumps.

Exchangeability with worn out products of other manufacturers

Pumps from IMP PUMPS are developed with international technical standards. They can replace worn out pumps from other manufacturers without additional expense or modified installation.

Expert help in selecting pumps for your heating system

Technically proficient sales staff in IMP PUMPS will advise you and help solve demanding problems in selecting the most suitable model of pump.

DIE VORTEILE KLEINER IMP PUMPS PUMPEN

Zuverlässiger Betrieb und lange Lebensdauer

Die neue Generation der kleinen Umwälzpumpen für das Hausheizsystem hat bei Tests der Strapazierfähigkeit und Dauerhaftigkeit bewiesen, dass sie zuverlässiges Funktionieren unter verschiedenen Arbeitsbedingungen garantiert. Spitzenmaterial, aus dem die Bestandteile der Pumpen gebaut sind, ermöglichen eine lange Lebensdauer der Pumpen.

Geräuscharmer Betrieb

Der geräuscharme Betrieb der Pumpen ist das Resultat sorgfältiger Entwicklung und fortschrittlicher technischer Lösungen bei der Gestaltung der Bestandteile der Pumpen.

Die Anpassungsfähigkeit der Pumpen an das Heizsystem

Der Dreistufenschalter ermöglicht die Wahl der Pumpenleistung und eine optimale Anpassung an die Erfordernisse des Heizsystems.

Das gesamte Montagematerial ist beigelegt

Damit Sie Zeit sparen und unnötiges Suchen von Montagematerial vermeiden können, haben wir allen Pumpen der Familie der kleinen Hauspumpen qualitätsvolle Dichtungen und zwei Verbindungsstücke beigelegt.

Austauschbarkeit mit ausgedienten Erzeugnissen anderer Hersteller

Die IMP PUMPS Pumpen sind in Übereinstimmung mit den internationalen technischen Standards entwickelt worden. Tauschen Sie ausgediente Pumpen anderer Hersteller durch entsprechende IMP PUMPS Pumpen ohne zusätzliche Kosten und ohne Veränderung der Installation aus

Fachliche Hilfe bei der Auswahl geeigneter Pumpen für das Heizsystem

Es beraten Sie technisch bewanderte Verkäufer des Unternehmens IMP PUMPS und sie lösen auch ein noch so anspruchsvolles Problem bei der Auswahl des geeignetsten Pumpensystems.

Three speeds circulation pumps with flanges - three-phases voltage
**Dreistufige Flanschumwälzpumpen mit manueller
 Drehzahlumschaltung - dreiphasenstrom**

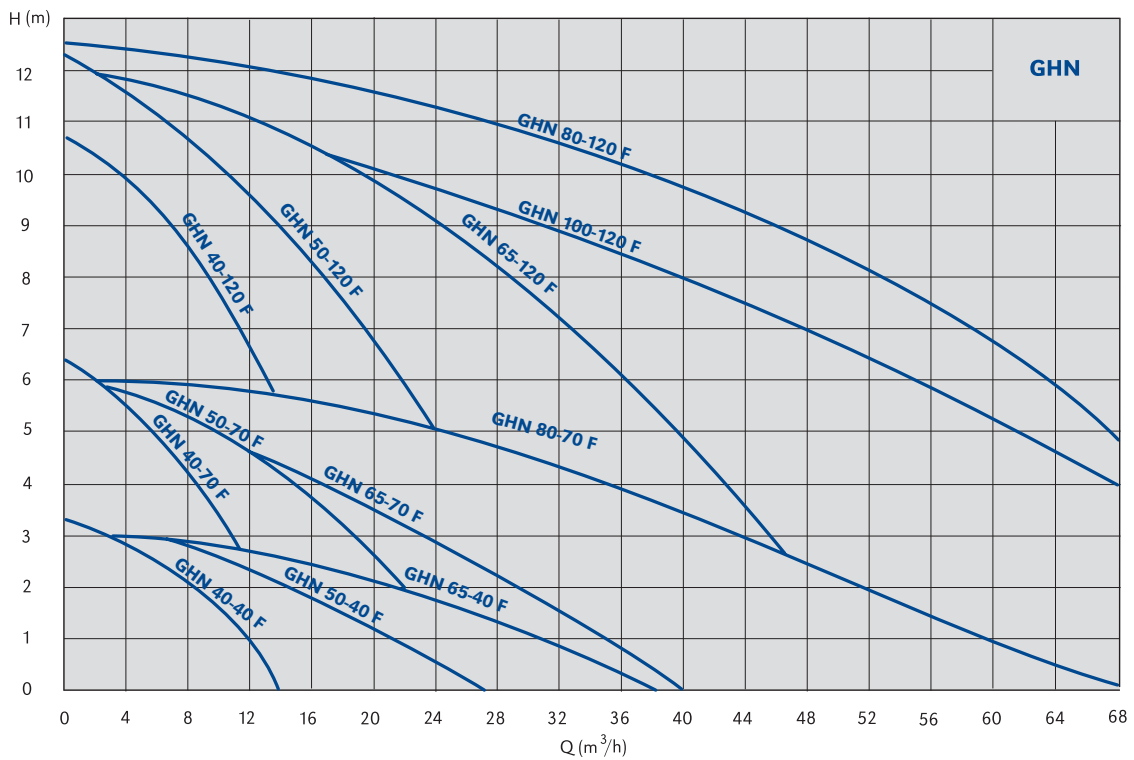
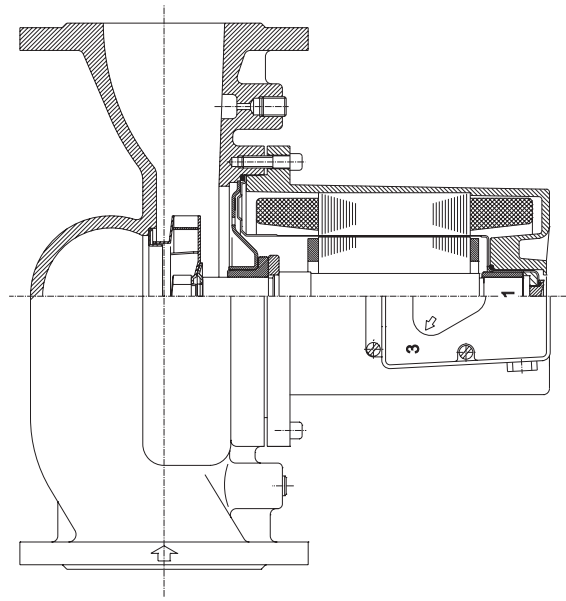
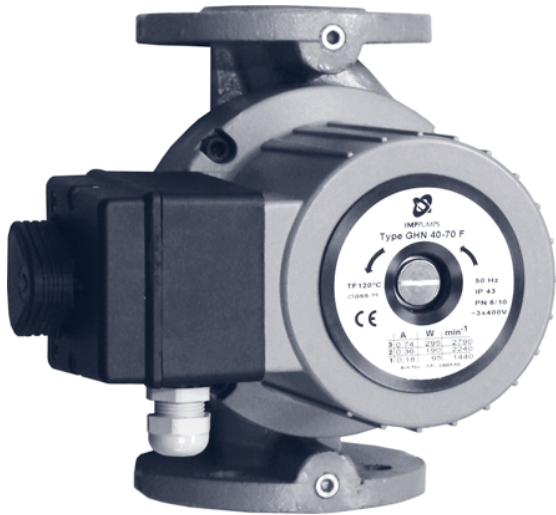

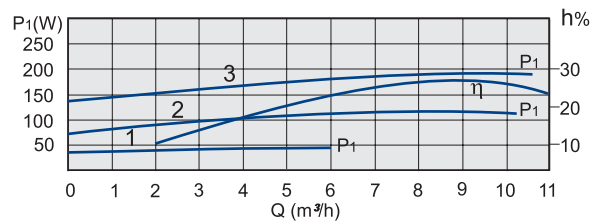
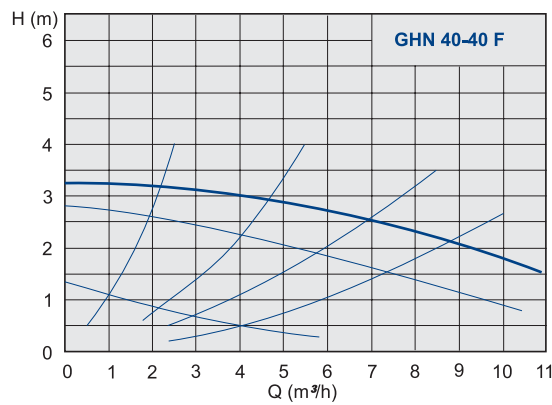
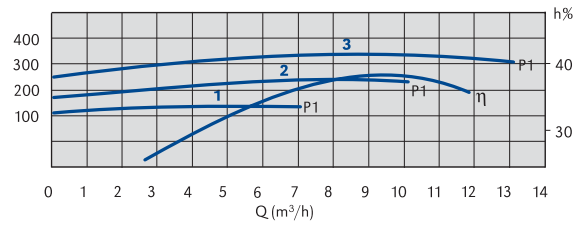
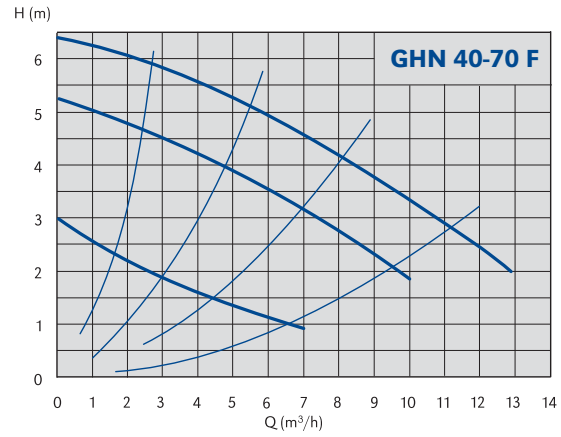
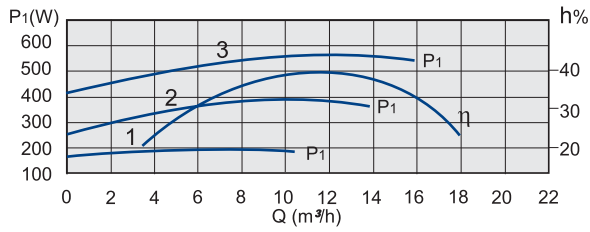
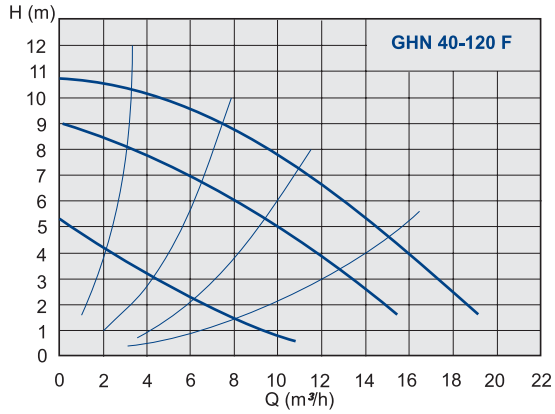

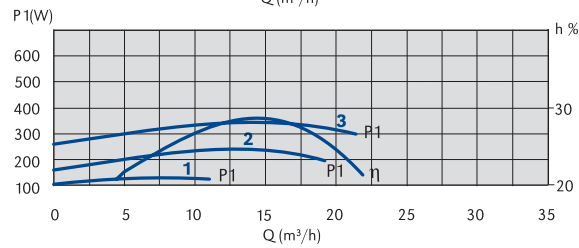
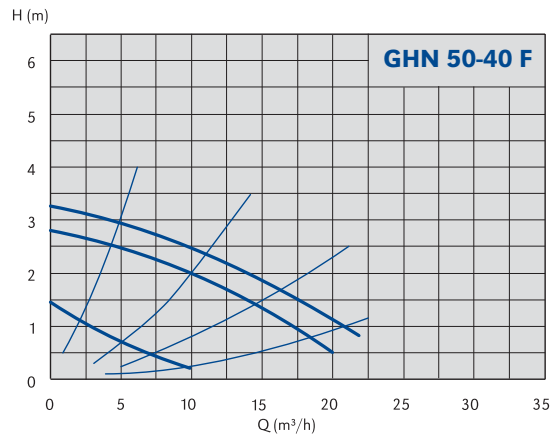
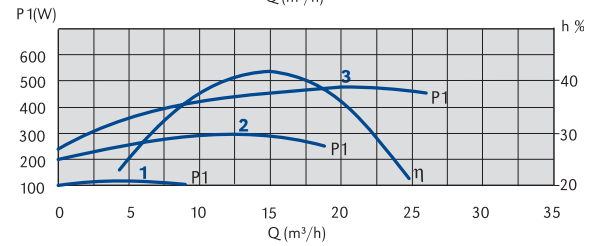
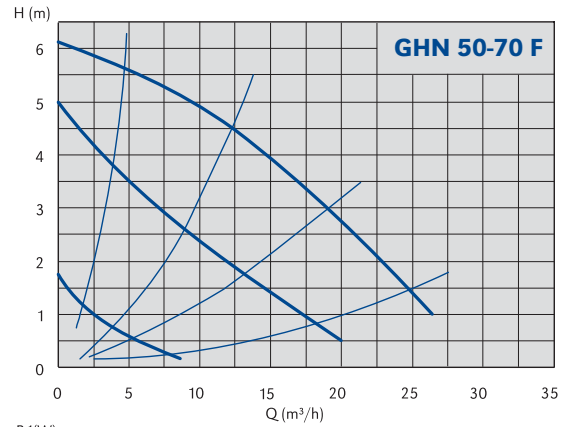
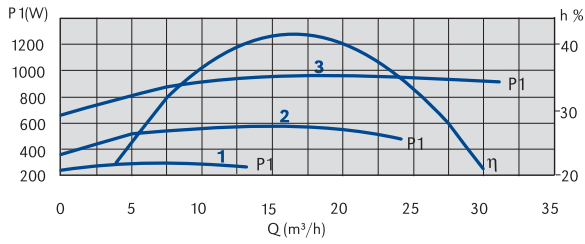
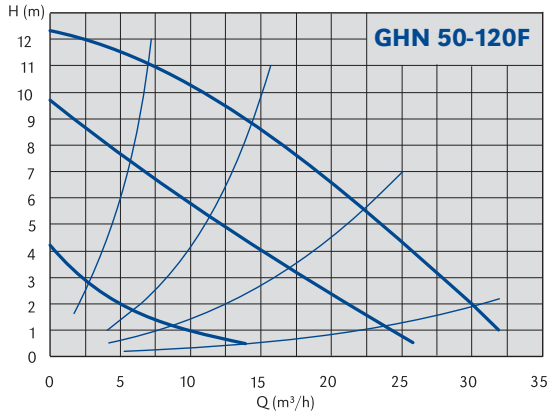

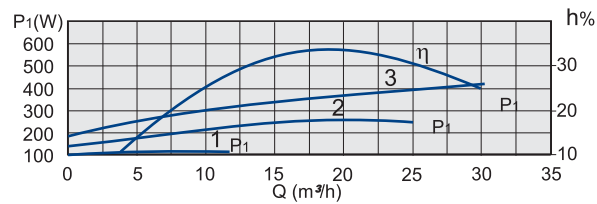
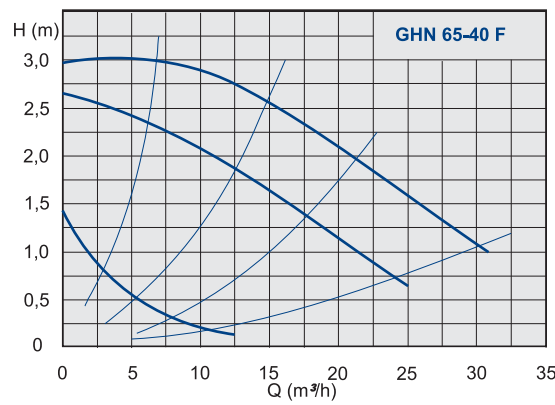
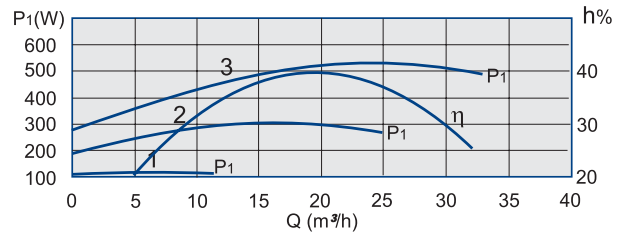
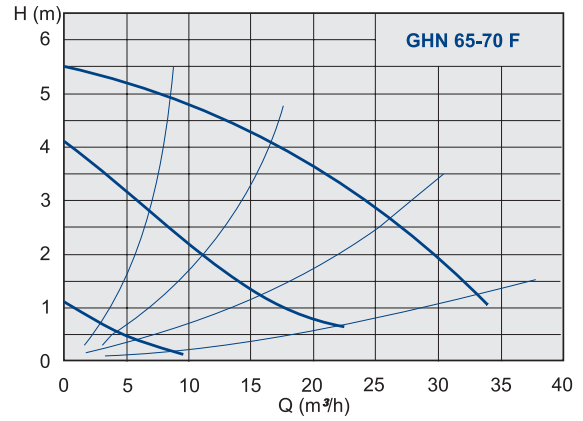
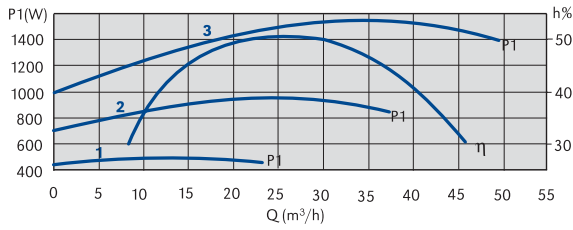
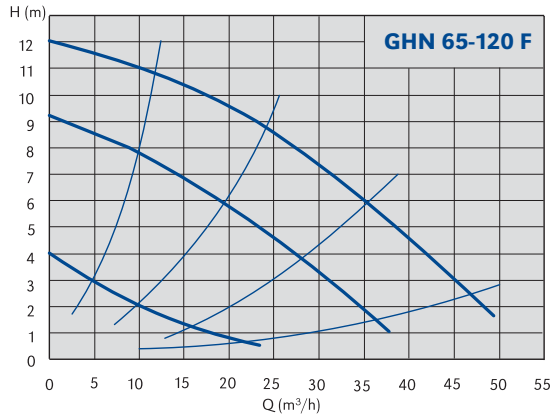

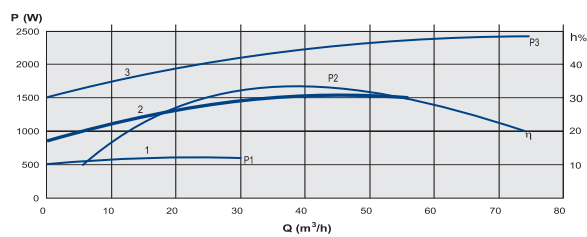
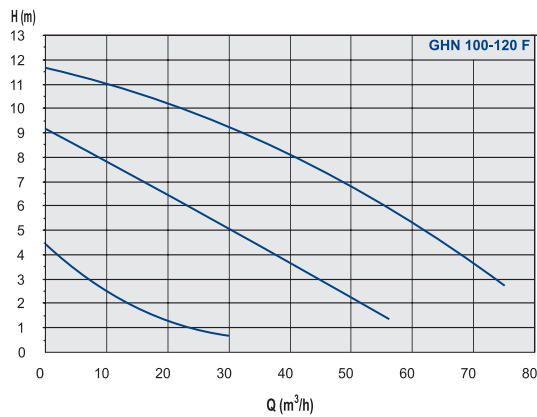
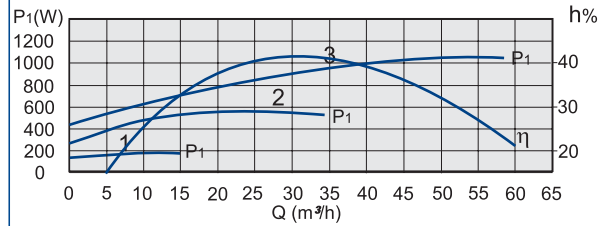
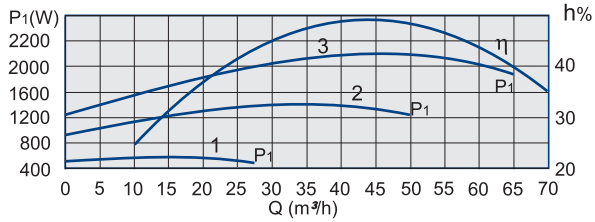
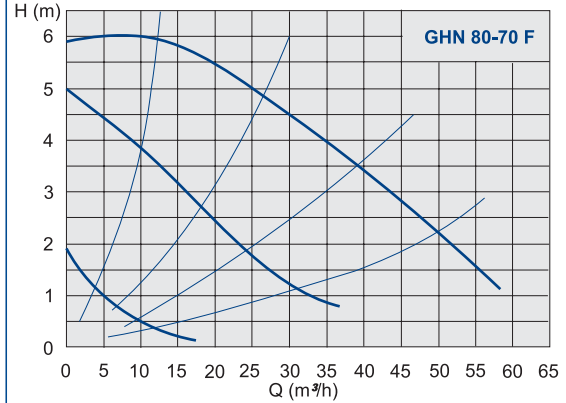
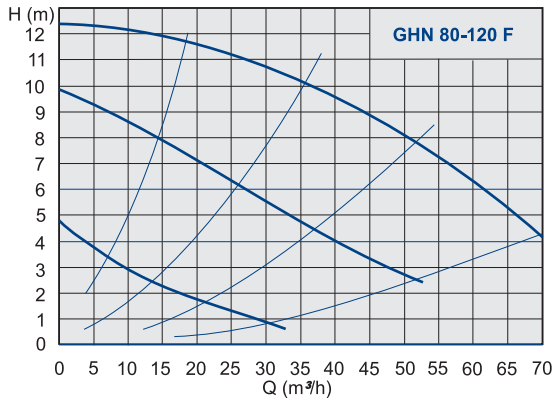

Three speeds twin circulation pumps with flanges - three-phases voltage
Dreistufige Zwillingsumwälzpumpen mit manueller
Drehzahlumschaltung - dreiphasenstrom

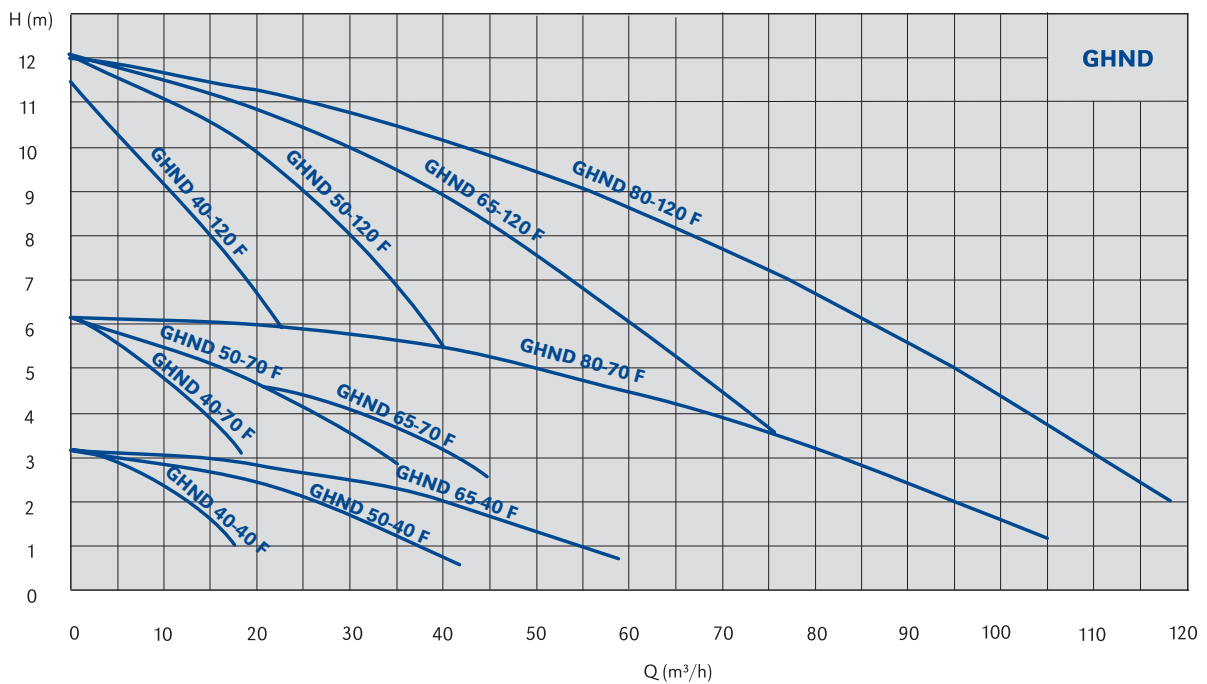
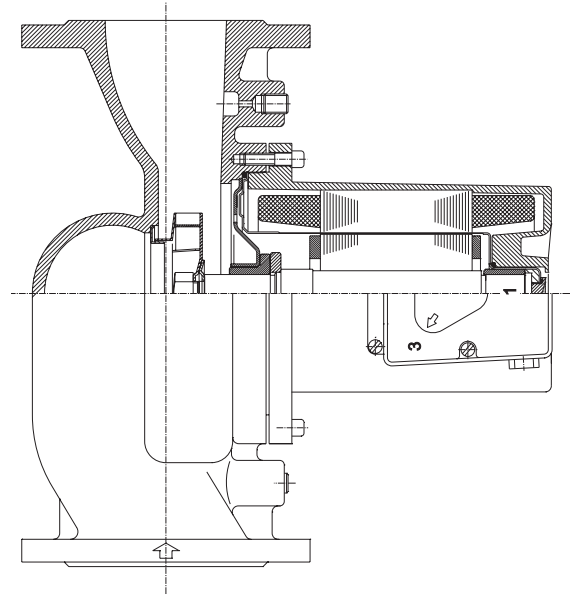
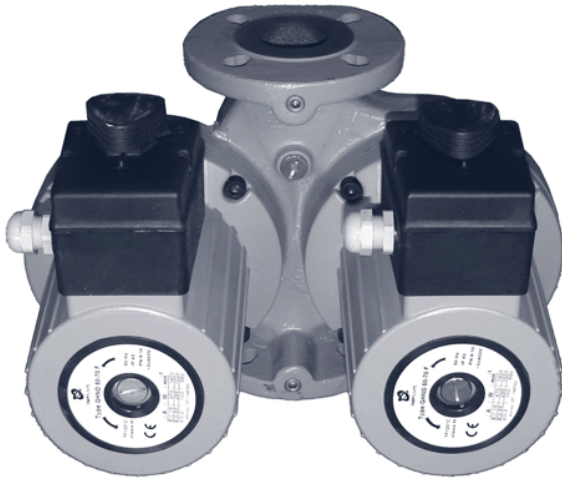

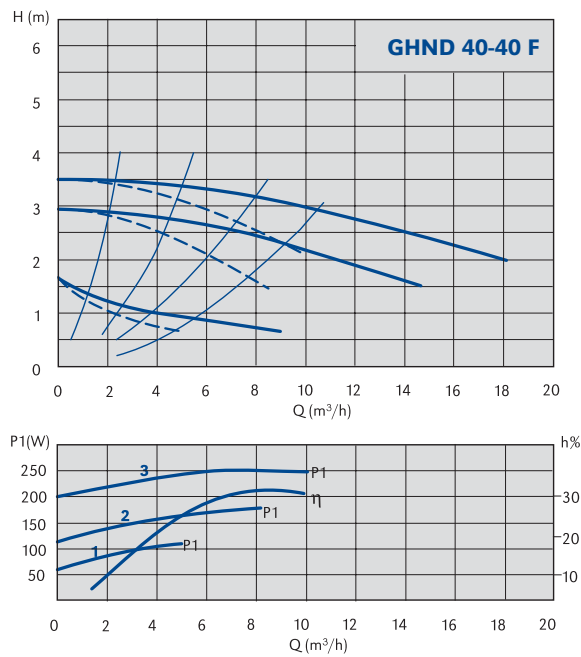
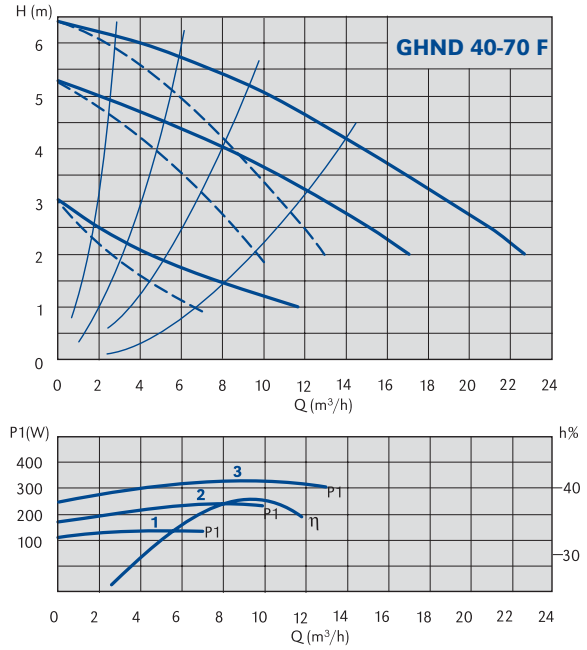
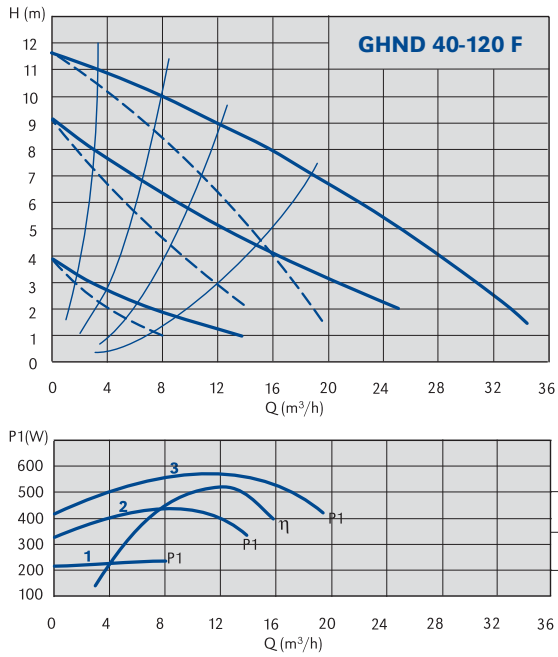

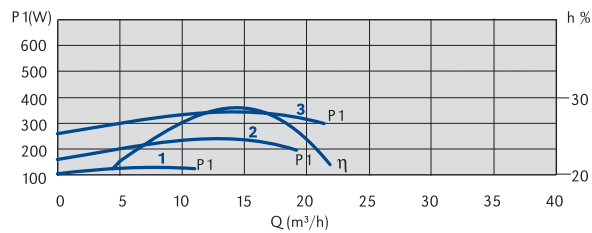
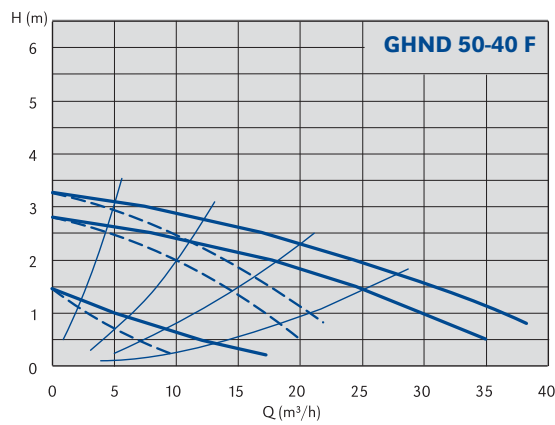
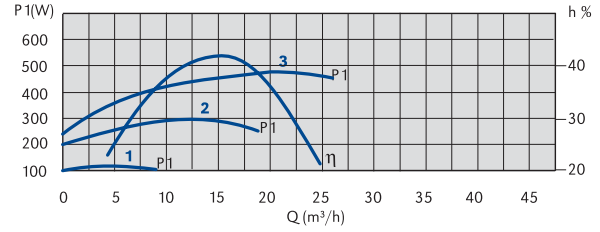
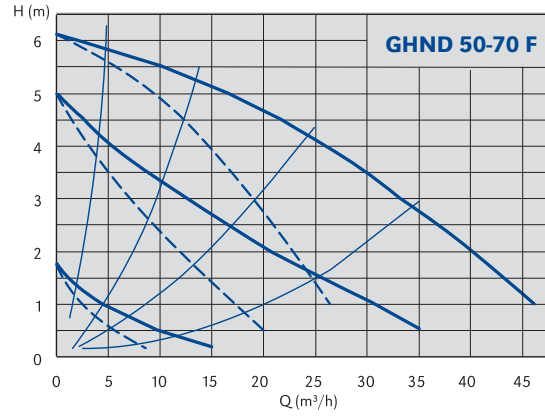
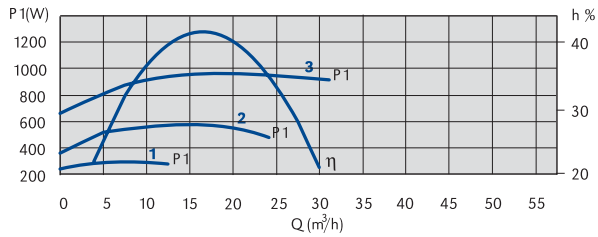
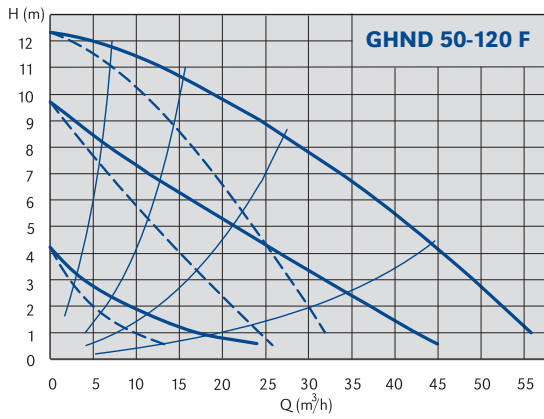

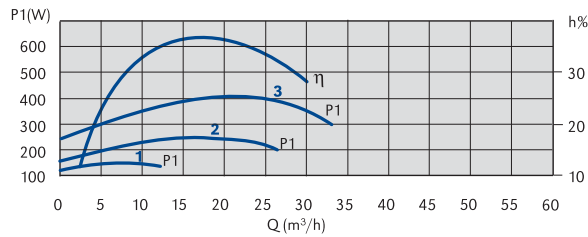
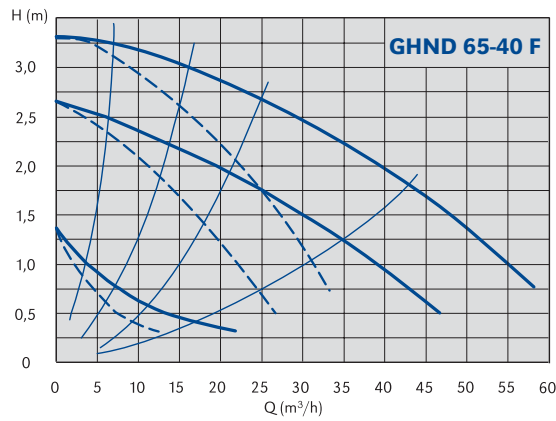
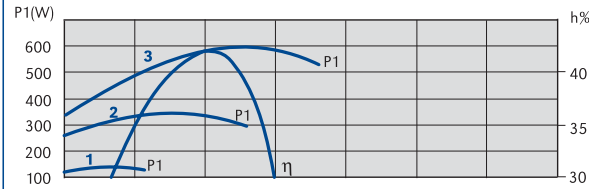
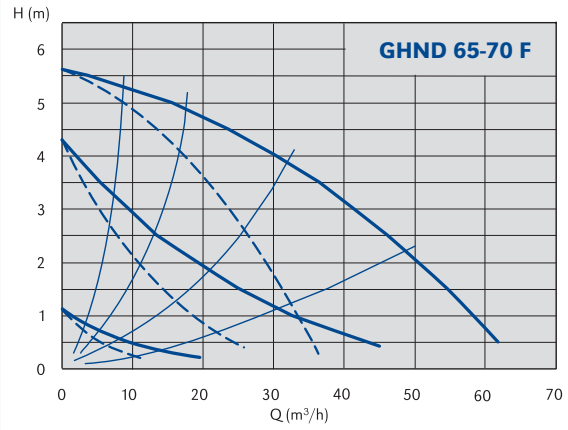
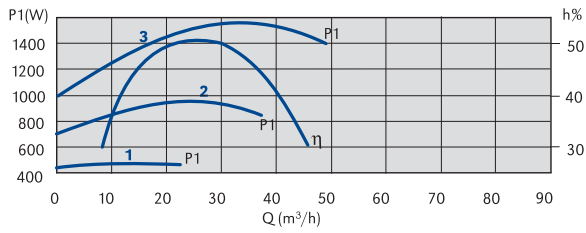
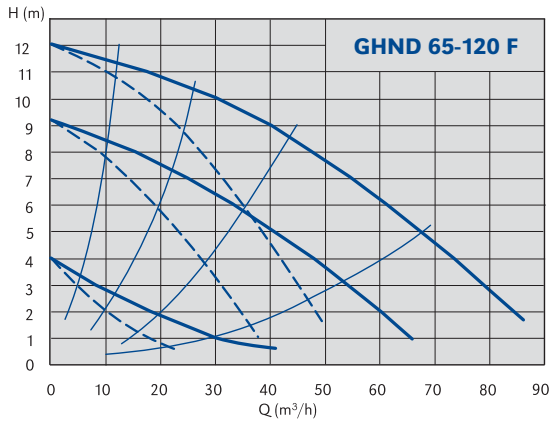

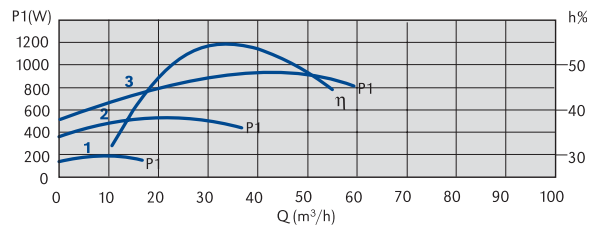
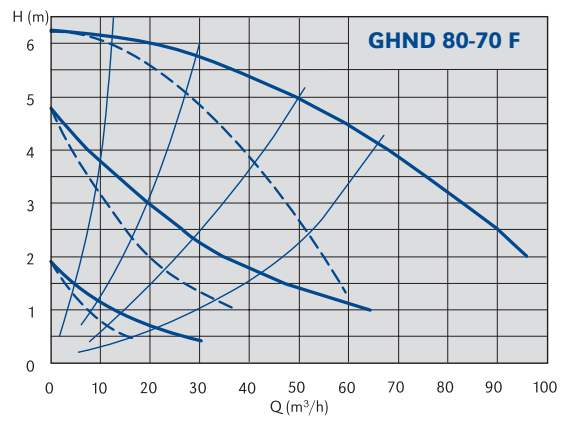
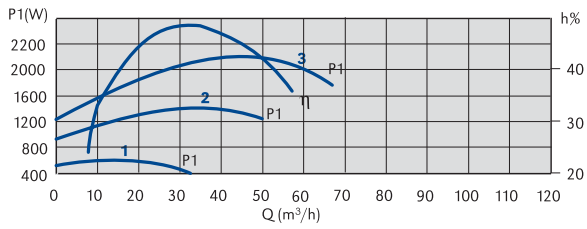
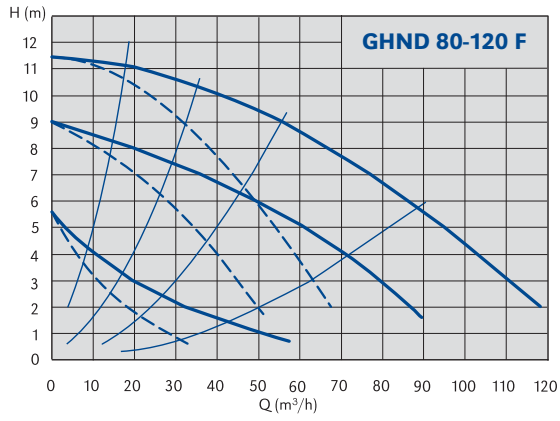

Three speeds circulation pumps with flanges - mono-phases voltage
 Dreistufige Flanschumwälzpumpen mit manueller
 Drehzahlumschaltung - einphasenstrom

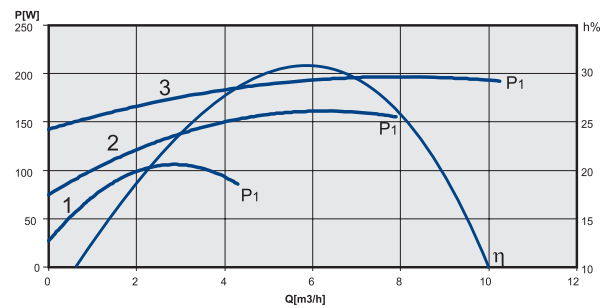
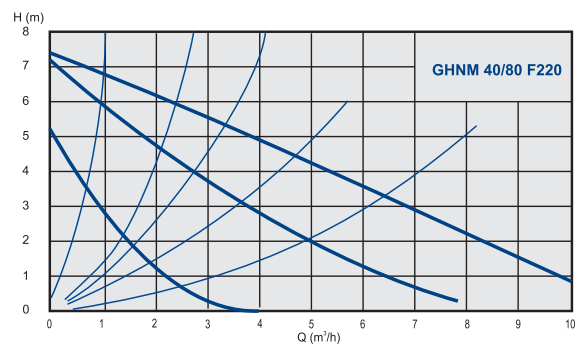
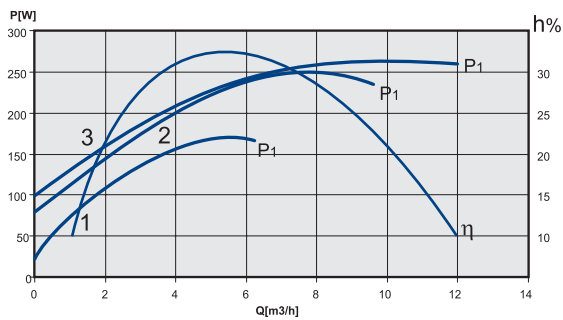
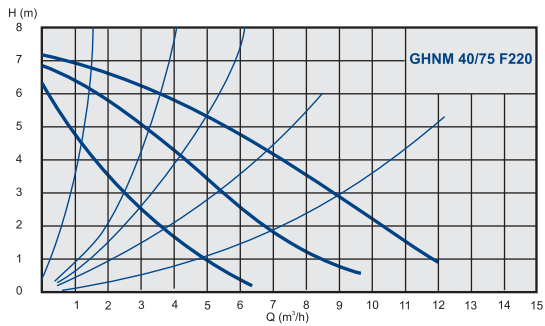
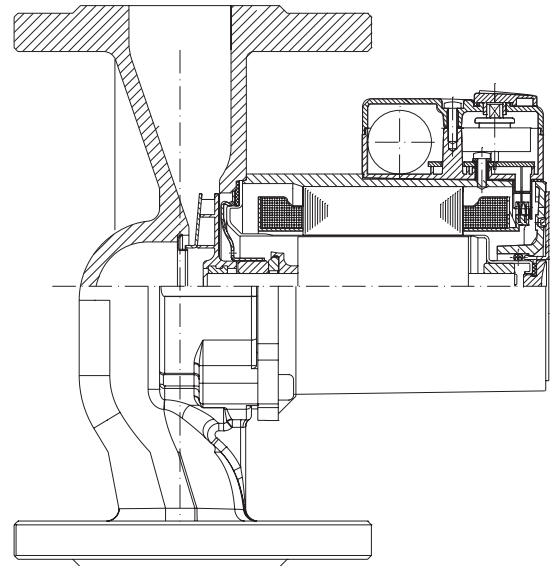

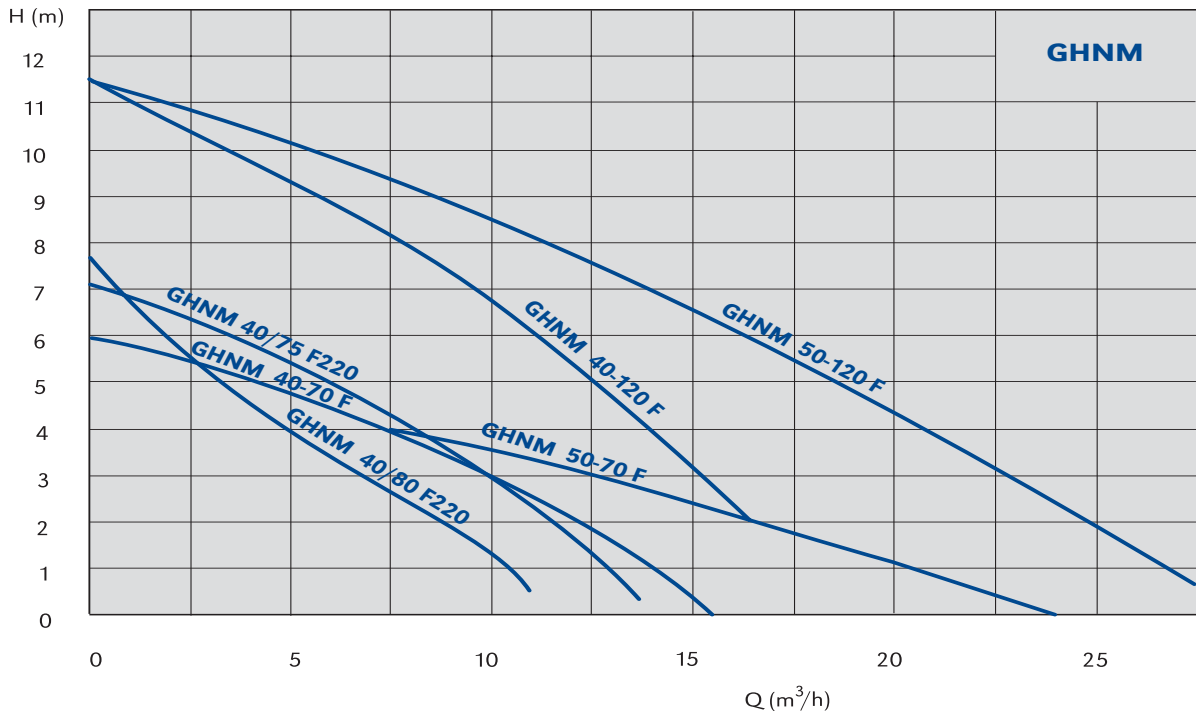
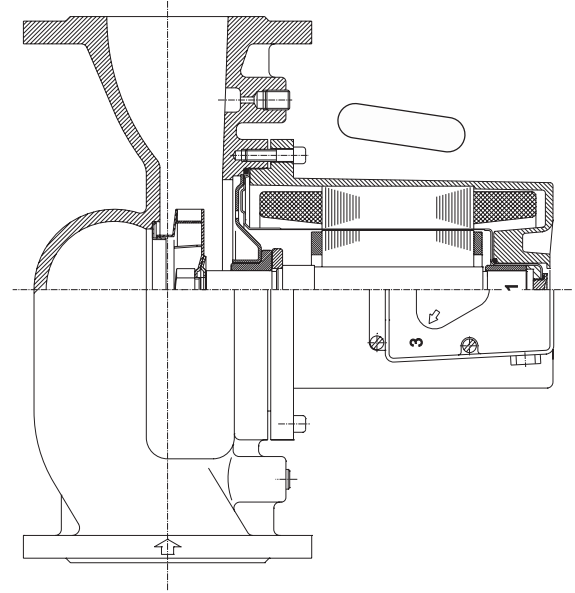
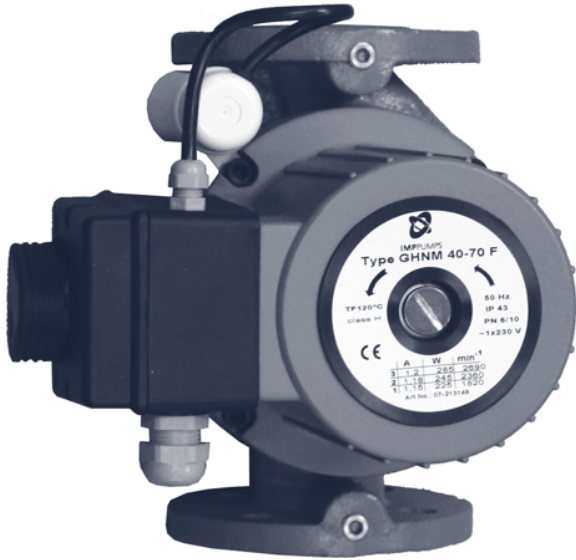

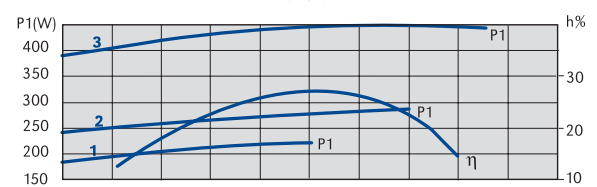
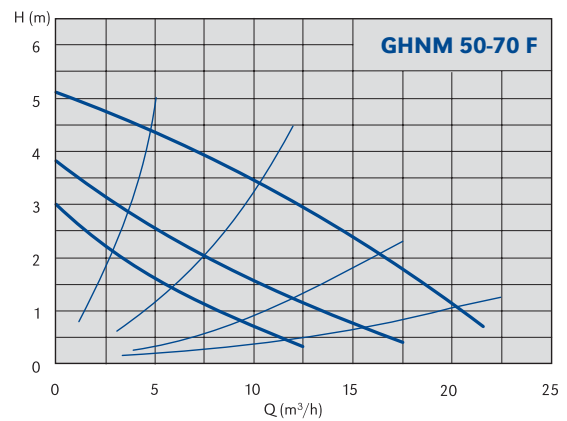
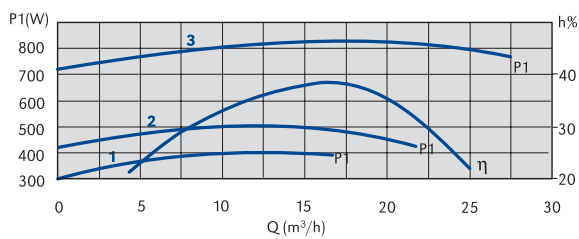
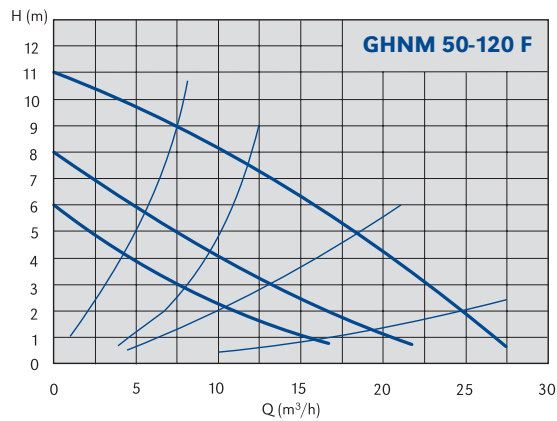
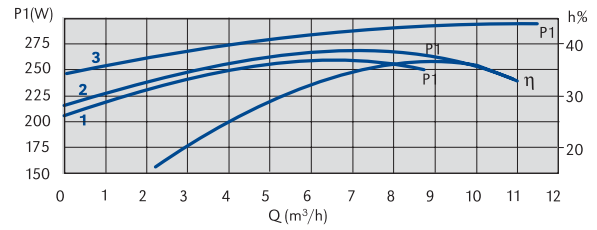
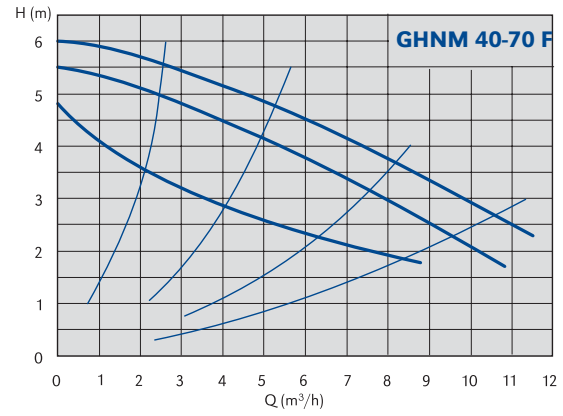
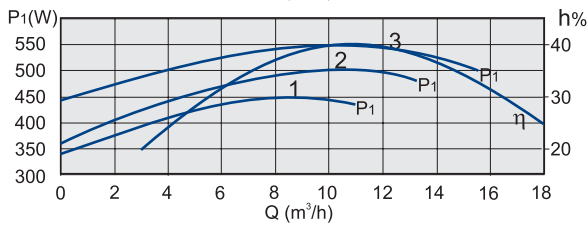
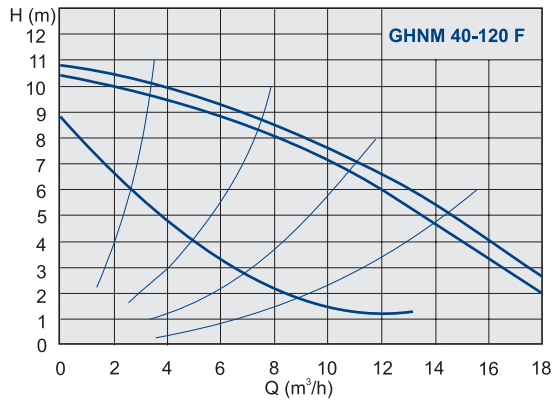

Three speeds twin circulation pumps with flanges - mono-phases voltage
 Dreistufige Zwillingsumwälzpumpen mit manueller Drehzahlumschaltung
 - einphasenstrom

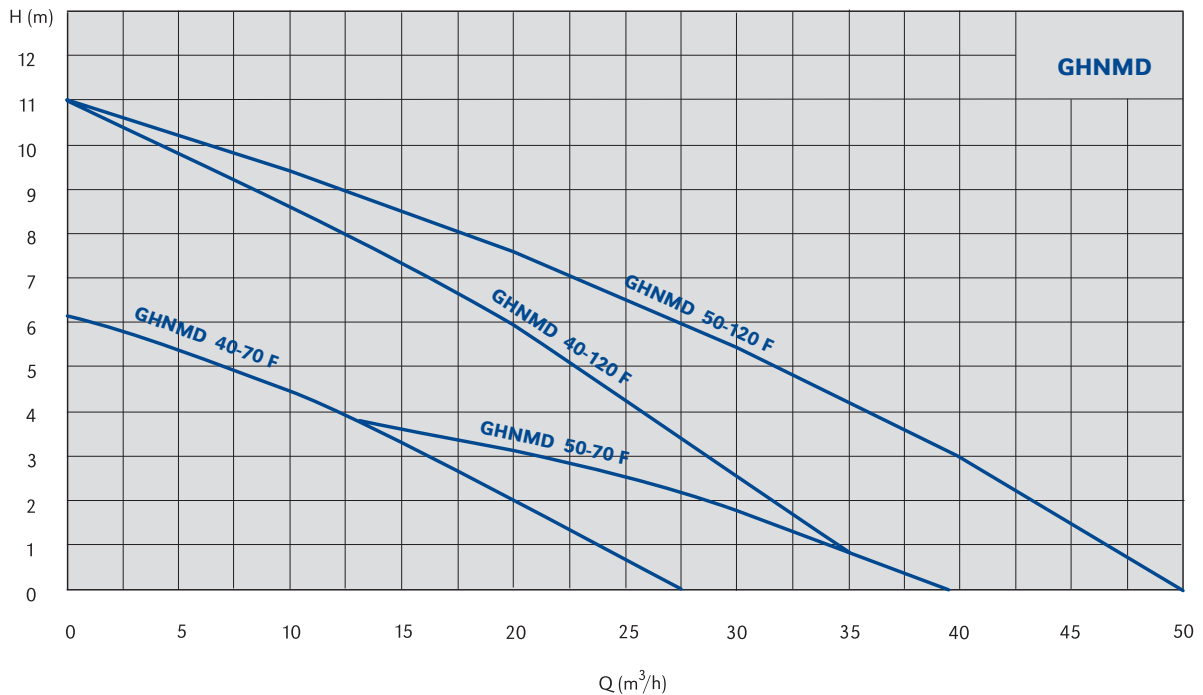
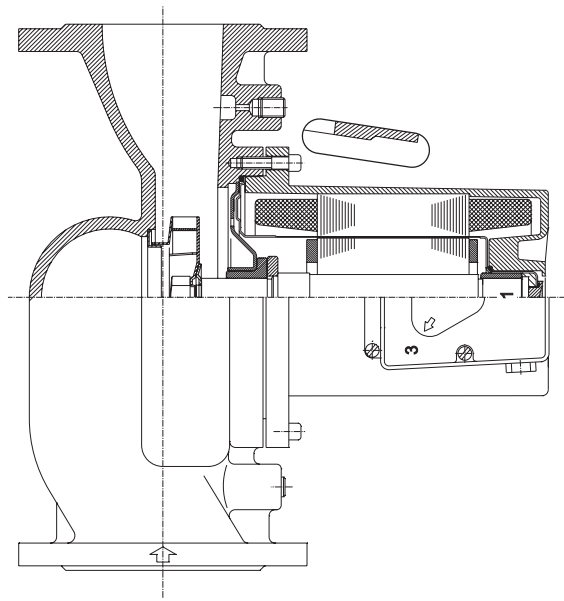
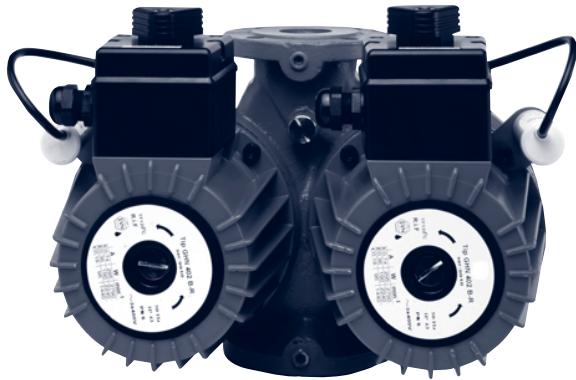

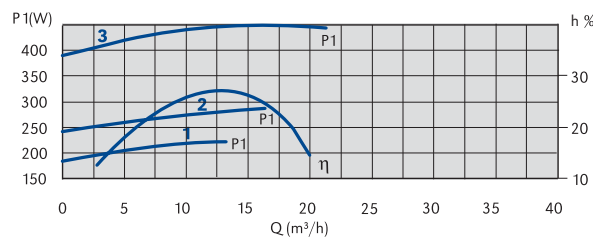
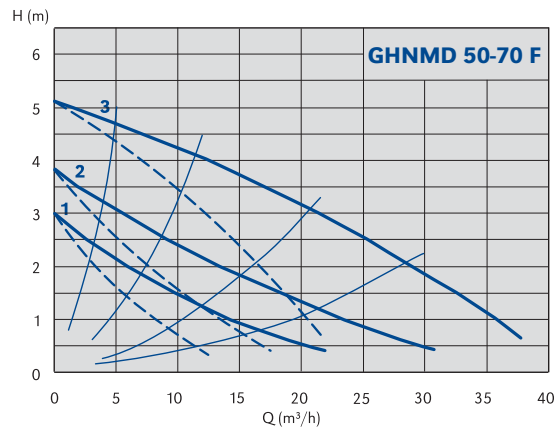
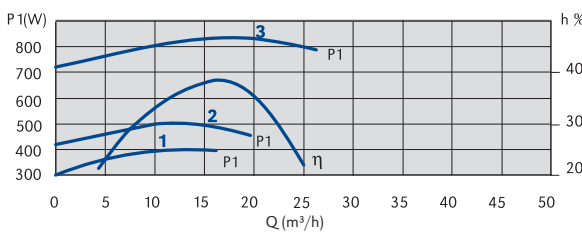
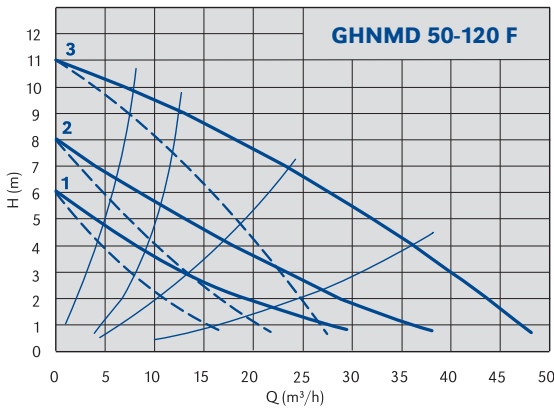
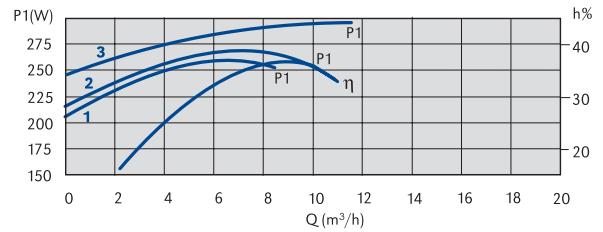
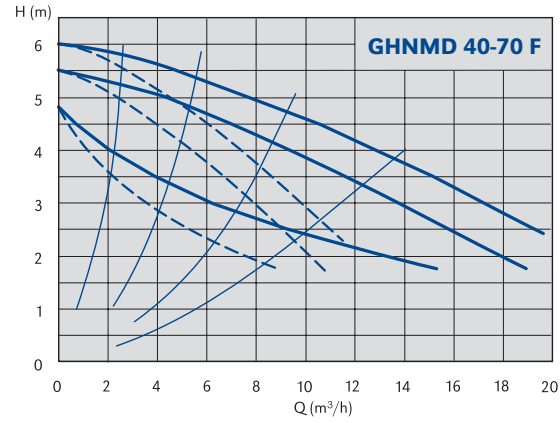
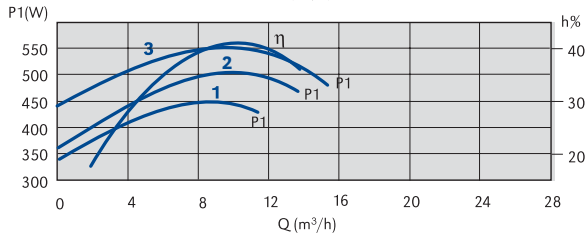
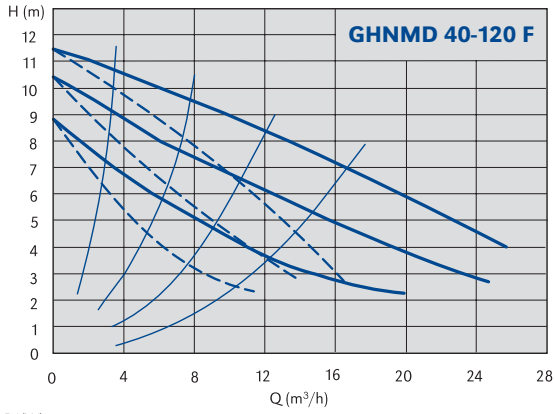

TEHNIICAL DATA / TECHNISCHE DATEN

pump type pumpentyp	code artikelnummer	connection type rohranschluss	max. flow durchfluss Q (m ³ /h)	max. Head Förder- höhe H (m)	system pressure systemdruck PN (bar)	min. - max. media temperature Temp. des medius Tmin-Tmax (°C)	casing type werkstoffe GG / Cast iron	single-S double-D einzelne-E zwillings- bauform-Z	weight gewicht (kg)	regulation geregelt yes /ja no /nein	degree of protection schutzart IP
GHN 15/40-130	979521960	Screw/Gewinde	3,5	4,0	PN 10	-10 – +110	GG/CI	S/E	2,2	no/nein	44
GHN 15/60-130	979521961	Screw/Gewinde	3,5	6,0	PN 10	-10 – +110	GG/CI	S/E	2,2	no/nein	44
GHN 15/65-130	979521962	Screw/Gewinde	4,0	6,5	PN 10	-10 – +110	GG/CI	S/E	2,2	no/nein	44
GHN 20/40-130	979521700	Screw/Gewinde	3,5	4,0	PN 10	-10 – +110	GG/CI	S/E	2,4	no/nein	44
GHN 25/40-130	979521701	Screw/Gewinde	3,5	4,0	PN 10	-10 – +110	GG/CI	S/E	2,4	no/nein	44
GHN 20/60-130	979521702	Screw/Gewinde	3,5	6,0	PN 10	-10 – +110	GG/CI	S/E	2,4	no/nein	44
GHN 25/60-130	979521703	Screw/Gewinde	3,5	6,0	PN 10	-10 – +110	GG/CI	S/E	2,4	no/nein	44
GHN 25/65-180	979521704	Screw/Gewinde	4,0	6,5	PN 10	-10 – +110	GG/CI	S/E	2,6	no/nein	44
GHN 32/65-180	979521705	Screw/Gewinde	4,0	6,5	PN 10	-10 – +110	GG/CI	S/E	3,0	no/nein	44
GHN 20/65-130	979521706	Screw/Gewinde	4,0	6,5	PN 10	-10 – +110	GG/CI	S/E	2,2	no/nein	44
GHN 25/65-130	979521707	Screw/Gewinde	4,0	6,5	PN 10	-10 – +110	GG/CI	S/E	2,4	no/nein	44
GHN 20/40-180	979521709	Screw/Gewinde	3,5	4,0	PN 10	-10 – +110	GG/CI	S/E	2,5	no/nein	44
GHN 25/40-180	979521710	Screw/Gewinde	3,5	4,0	PN 10	-10 – +110	GG/CI	S/E	2,6	no/nein	44
GHN 32/40-180	979521711	Screw/Gewinde	3,5	4,0	PN 10	-10 – +110	GG/CI	S/E	3	no/nein	44
GHN 20/60-180	979521712	Screw/Gewinde	3,5	6,0	PN 10	-10 – +110	GG/CI	S/E	2,6	no/nein	44
GHN 25/60-180	979521713	Screw/Gewinde	3,5	6,0	PN 10	-10 – +110	GG/CI	S/E	2,6	no/nein	44
GHN 32/60-180	979521714	Screw/Gewinde	3,5	6,0	PN 10	-10 – +110	GG/CI	S/E	3	no/nein	44
GHN 25/70-180	979521987	Screw/Gewinde	6,0	6,8	PN 10	-10 – +110	GG/CI	S/E	3,2	no/nein	44
GHN 32/70-180	979521983	Screw/Gewinde	6,0	6,8	PN 10	-10 – +110	GG/CI	S/E	3,2	no/nein	44
GHN 32/75-180	979522752	Screw/Gewinde	12	7,1	PN 10	-10 – +110	GG/CI	S/E		no/nein	44
GHN 32/80-180	979521944	Screw/Gewinde	8,4	8,0	PN 10	-10 – +110	GG/CI	S/E	4,8	no/nein	44
GHN 32/120-180	979522005	Screw/Gewinde	9,5	12	PN 10	-10 – +110	GG/CI	S/E	5,6	no/nein	44
GHND 32/70-180	979522021	Screw/Gewinde	10,8	6,4	PN 10	-10 – +110	GG/CI	D/Z	5,5	no/nein	44
GHND 32/80-180	979522022	Screw/Gewinde	14,4	7,3	PN 10	-10 – +110	GG/CI	D/Z	9,2	no/nein	44
GHND 32/120-180	979522023	Screw/Gewinde	14,3	10,8	PN 10	-10 – +110	GG/CI	D/Z	10	no/nein	44
GHN 40-120 F	979521446	Flanges/Flansche	20	12	PN 6 / 10	-10 – +120	GG/CI	S/E	20	no/nein	43
GHN 40-70 F	979521447	Flanges/Flansche	13	6	PN 6 / 10	-10 – +120	GG/CI	S/E	19	no/nein	43
GHN 440-40 F	979521448	Flanges/Flansche	10	3,5	PN 6 / 10	-10 – +120	GG/CI	S/E	18	no/nein	43
GHN 50-120 F	979521508	Flanges/Flansche	30	12	PN 6 / 10	-10 – +120	GG/CI	S/E	25	no/nein	43
GHN 50-70 F	979521509	Flanges/Flansche	25	6	PN 6 / 10	-10 – +120	GG/CI	S/E	25	no/nein	43
GHN 50-40 F	979521510	Flanges/Flansche	20	3,5	PN 6 / 10	-10 – +120	GG/CI	S/E	23	no/nein	43
GHN 65-120 F	979521470	Flanges/Flansche	50	12	PN 6 / 10	-10 – +120	GG/CI	S/E	31	no/nein	43
GHN 65-70 F	979521471	Flanges/Flansche	35	6	PN 6 / 10	-10 – +120	GG/CI	S/E	30	no/nein	43
GHN 65-40 F	979521472	Flanges/Flansche	33	3,5	PN 6 / 10	-10 – +120	GG/CI	S/E	30	no/nein	43
GHN 80-120 F	979521482	Flanges/Flansche	70	12	PN 6	-10 – +120	GG/CI	S/E	37	no/nein	43
GHN 80-70 F	979521483	Flanges/Flansche	70	12	PN 10	-10 – +120	GG/CI	S/E	36	no/nein	43
GHN 80-120 F (PN10)	979521496	Flanges/Flansche	60	6	PN 6	-10 – +120	GG/CI	S/E	37	no/nein	43
GHN 80-70 F (PN10)	979521497	Flanges/Flansche	60	6	PN 10	-10 – +120	GG/CI	S/E	36	no/nein	43
GHN 100-120F (PN 6)	979522756	Flanges/Flansche	75	11,5	PN 6	-10 – +120	GG/CI	S/E		no/nein	43
GHN 100-120 (PN 10)	979522755	Flanges/Flansche	75	11,5	PN 10	-10 – +120	GG/CI	S/E		no/nein	43
GHND 40-120 F	979521452	Flanges/Flansche	34	12	PN 6 / 10	-10 – +120	GG/CI	D/Z	35	no/nein	43
GHND 40-70 F	979521453	Flanges/Flansche	22	6	PN 6 / 10	-10 – +120	GG/CI	D/Z	35	no/nein	43
GHND 40-40 F	979521454	Flanges/Flansche	18	3,5	PN 6 / 10	-10 – +120	GG/CI	D/Z	34	no/nein	43
GHND 50-120 F	979521464	Flanges/Flansche	55	12	PN 6 / 10	-10 – +120	GG/CI	D/Z	47	no/nein	43
GHND 50-70 F	979521465	Flanges/Flansche	45	6	PN 6 / 10	-10 – +120	GG/CI	D/Z	46	no/nein	43
GHND 50-40 F	979521466	Flanges/Flansche	38	3,5	PN 6 / 10	-10 – +120	GG/CI	D/Z	44	no/nein	43
GHND 65-120 F	979521476	Flanges/Flansche	85	12	PN 6 / 10	-10 – +120	GG/CI	D/Z	56	no/nein	43
GHND 65-70 F	979521477	Flanges/Flansche	60	6	PN 6 / 10	-10 – +120	GG/CI	D/Z	52	no/nein	43
GHND 65-40 F	979521478	Flanges/Flansche	55	3,5	PN 6 / 10	-10 – +120	GG/CI	D/Z	49	no/nein	43
GHND 80-120 F	979521488	Flanges/Flansche	120	12	PN 6	-10 – +120	GG/CI	D/Z	60	no/nein	43
GHND 80-70 F	979521489	Flanges/Flansche	95	6	PN 6	-10 – +120	GG/CI	D/Z	57	no/nein	43
GHND 80-120 F (PN10)	979521993	Flanges/Flansche	120	12	PN 10	-10 – +110	GG/CI	D/Z	60	no/nein	44
GHND 80-70 F (PN10)	979521994	Flanges/Flansche	95	6	PN 10	-10 – +120	GG/CI	D/Z	57	no/nein	43
GHNM 40/75 F 220	979522753	Flanges/Flansche	12	7,1	PN 10	-10 – +110	GG/CI	S/E		no/nein	43
GHNM 40/80 F 220	979522754	Flanges/Flansche	10,25	7,4	PN 10	-10 – +110	GG/CI	S/E		no/nein	43

TEHNICAL DATA / TECHNISCHE DATEN

pump type pumpentyp	code artikelnummer	connection type rohranschluss	max. flow durchfluss Q (m ³ /h)	max. Head Förder- höhe H (m)	system pressure systemdruck PN (bar)	min. - max. media temperature temp. des medius Tmin-Tmax (°C)	casing type werkstoffe GG / Cast iron	single-S double-D einzelne-E zwillings- bauform-Z	weight gewicht (kg)	regulation geregelt yes / ja no / nein	degree of protection schutzart IP
GHNM 40 - 120 F	979521449	Flanges/Flansche	16	12	PN 6 / 10	-10 – +120	GG/CI	D/Z	20	no/nein	43
GHNM 40 - 70 F	979521450	Flanges/Flansche	11	6	PN 6 / 10	-10 – +120	GG/CI	S/E	18	no/nein	43
GHNM 50 - 120 F	979521511	Flanges/Flansche	28	12	PN 6 / 10	-10 – +120	GG/CI	S/E	25	no/nein	43
GHNM 50 - 70 F	979521462	Flanges/Flansche	22	6	PN 6 / 10	-10 – +120	GG/CI	S/E	23	no/nein	43
GHNMD 40 - 120 F	979521455	Flanges/Flansche	26	12	PN 6 / 10	-10 – +120	GG/CI	D/Z	39	no/nein	43
GHNMD 40 - 70 F	979521456	Flanges/Flansche	20	6	PN 6 / 10	-10 – +120	GG/CI	D/Z	35	no/nein	43
GHNMD 50 - 120 F	979521467	Flanges/Flansche	48	12	PN 6 / 10	-10 – +120	GG/CI	D/Z	49	no/nein	43
GHNMD 50 - 70 F	979521468	Flanges/Flansche	38	6	PN 6 / 10	-10 – +120	GG/CI	D/Z	44	no/nein	43

DIMENSIONS / MAßE

	pump type pumpentyp	code artikelnummer	length einbaulänge L (mm)	connection size rohranschluss DN	a	l	b1	b2	R	b	h1
1	GHN 15/40-130	979521960	130	DN 15	28	108	80	44			
	GHN 15/60-130	979521961	130	DN 15	28	108	80	44			
	GHN 15/65-130	979521962	130	DN 15	28	108	80	44			
	GHN 20/40-130	979521700	130	DN 20	28	108	80	44			
	GHN 25/40-130	979521701	130	DN 25	28	108	80	44			
	GHN 20/60-130	979521702	130	DN 20	28	108	80	44			
	GHN 25/60-130	979521703	130	DN 25	28	108	80	44			
	GHN 25/65-180	979521704	180	DN 25	28	108	80	44			
	GHN 32/65-180	979521705	180	DN 32	30	108	80	44			
	GHN 20/65-130	979521706	130	DN 20	28	108	80	44			
	GHN 25/65-130	979521707	130	DN 25	28	108	80	44			
	GHN 20/40-180	979521709	180	DN 20	28	108	80	44			
	GHN 25/40-180	979521710	180	DN 25	28	108	80	44			
	GHN 32/40-180	979521711	180	DN 32	30	108	80	44			
	GHN 20/60-180	979521712	180	DN 20	28	108	80	44			
	GHN 25/60-180	979521713	180	DN 25	28	108	80	44			
	GHN 32/60-180	979521714	180	DN 32	30	108	80	44			
	GHN 25/70-180	979521987	180	DN 25	30	108	80	44			
	GHN 32/70-180	979521983	180	DN 32	30	108	80	44			
	GHN 32/75-180	979522752	180	DN 32	65	174	80	75			
GHN 32/80-180	979522005	180	DN 32	31	150	80	57				
GHN 32/120-180	979521944	180	DN 32	31	173	80	67				
2	GHND 32/70-180	979522021	180	DN 32	29	212	85			240	78
	GHND 32/80-180	979522022	180	DN 32	40	142	85			255	77,5
	GHND 32/120-180	979522023	180	DN 32	34	168	85			280	79
4	GHN 40-120 F	979521446	250	DN 40	65	198	153	92	1/4"		
	GHN 40-70 F	979521447	250	DN 40	65	198	153	92	1/4"		
	GHN 440-40 F	979521448	250	DN 40	65	198	153	92	1/4"		
	GHN 50-120 F	979521508	280	DN 50	70	250	160	113	1/4"		
	GHN 50-70 F	979521509	280	DN 50	70	250	160	113	1/4"		
	GHN 50-40 F	979521510	280	DN 50	70	250	160	113	1/4"		
	GHN 65-120 F	979521470	340	DN 65	80	252	160	123	1/4"		
	GHN 65-70 F	979521471	340	DN 65	80	252	160	123	1/4"		
	GHN 65-40 F	979521472	340	DN 65	80	252	160	123	1/4"		
	GHN 80-120 F	979521482	360	DN 80	100	257	160	129,5	1/4"		
	GHN 80-70 F	979521483	360	DN 80	100	257	160	129,5	1/4"		
	GHN 80-120 F (PN10)	979521496	360	DN 80	100	257	160	129,5	1/4"		
	GHN 80-70 F (PN10)	979521497	360	DN 80	100	257	160	129,5	1/4"		
	GHN 100-120 F (PN 6)	979522756	360	DN 100	110	257	160	130	1/4"		
GHN 100-120 F (PN 10)	979522755	360	DN 100	110	257	160	130	1/4"			
5	GHND 40-120 F	979521452	250	DN 40	62	198	153		1/4"	346	110
	GHND 40-70 F	979521453	250	DN 40	62	198	153		1/4"	346	110
	GHND 40-40 F	979521454	250	DN 40	62	198	153		1/4"	346	110
	GHND 50-120 F	979521464	280	DN 50	70	250	160		1/4"	400	121
	GHND 50-70 F	979521465	280	DN 50	70	250	160		1/4"	400	121
	GHND 50-40 F	979521466	280	DN 50	70	250	160		1/4"	400	121
	GHND 65-120 F	979521476	340	DN 65	80	252	160		1/4"	450	141
	GHND 65-70 F	979521477	340	DN 65	80	252	160		1/4"	450	141
	GHND 65-40 F	979521478	340	DN 65	80	252	160		1/4"	450	141
	GHND 80-120 F	979521488	360	DN 80	95	257	160		1/4"	470	146
	GHND 80-70 F	979521489	360	DN 80	95	257	160		1/4"	470	146
	GHND 80-120 F (PN10)	979521993	360	DN 80	95	257	160		1/4"	470	146
	GHND 80-70 F (PN10)	979521994	360	DN 80	95	257	160		1/4"	470	146
	3	GHNM 40/75-F 220	979522752	220	DN 40	65	174	80	75		
GHNM 40/80 F220		979522754	220	DN 40	65	145	80	75			

DIMENSIONS / MAßE

	pump type pumpentyp	code artikelnummer	length einbaulänge L (mm)	connection size rohranschluss DN	a	l	b1	b2	R	b	h1
4	GHNM 40 - 120 F	979521449	250	DN 40	65	198	153	92	1/4"		
	GHNM 40 - 70 F	979521450	250	DN 40	65	198	153	92	1/4"		
5	GHNM 50 - 120 F	979521511	280	DN 50	70	250	160	113	1/4"		
	GHNM 50 - 70 F	979521462	280	DN 50	70	250	160	113	1/4"		
	GHNMD 40 - 120 F	979521455	250	DN 40	62	198	153		1/4"	346	110
	GHNMD 40 - 70 F	979521456	250	DN 40	62	198	153		1/4"	346	110
	GHNMD 50 - 120 F	979521467	280	DN 50	70	250	160		1/4"	400	121
	GHNMD 50 - 70 F	979521468	280	DN 50	70	250	160		1/4"	400	121

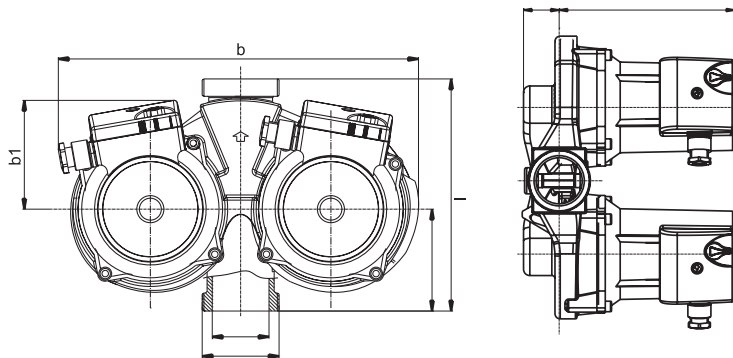
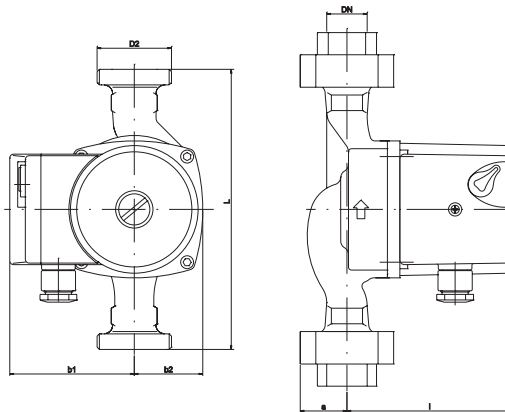

3

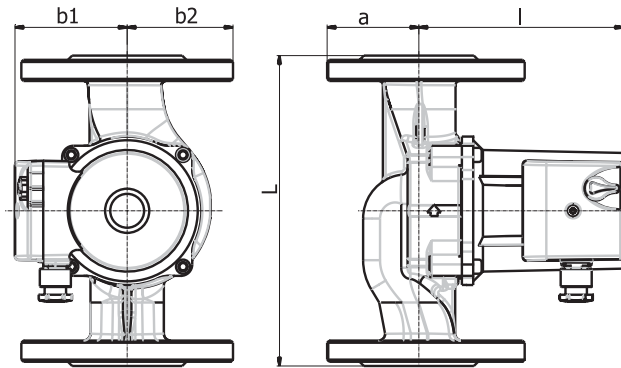



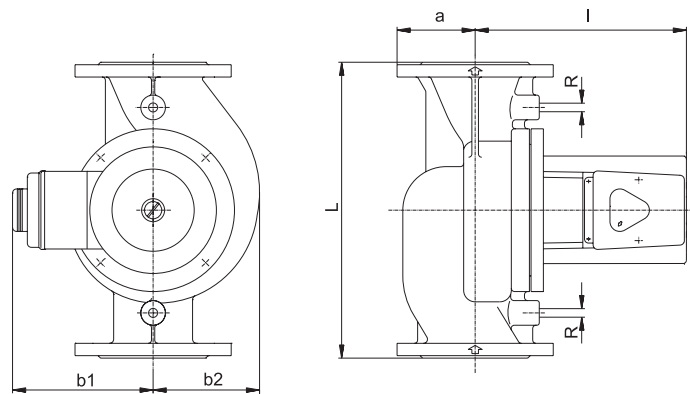



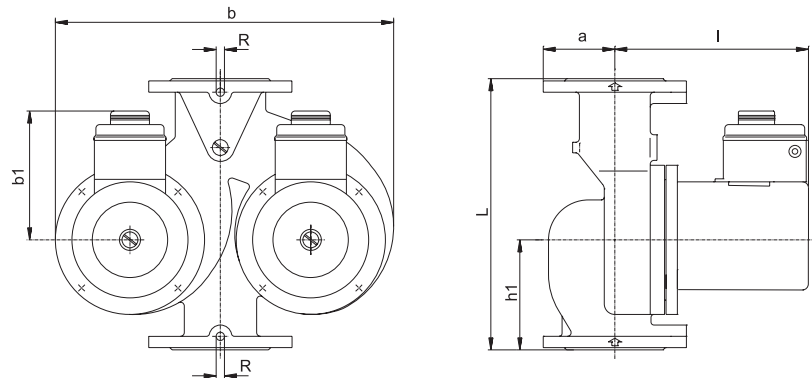

4



5



ELECTRICAL DATA / ELEKTRISCHE DATEN							MAX WORKING PRESSURE (bar) MAX ZÜLASSIGER BETRIEBSDRUCK		
pump type pumpentyp	code artikelnummer	power max. leistung- aufnahme P (W)	speed range drehzahlstufe (min-1)	FLC I nennstrom In (A)	electrical voltage elektroanschluss I (V)	insulating class isoliationsklasse	temperature / temperatur		
							50°C	80°C	110°C
 GHN 15/40-130	979521960	50	1315 - 2456	0,17 - 0,23	230 V	H	0,05	0,4	1,1
GHN 15/60-130	979521961	90	1080 - 1980	0,17 - 0,39	230 V	H	0,05	0,4	1,1
GHN 15/65-130	979521962	95	1080 - 1980	0,19 - 0,44	230 V	H	0,05	0,4	1,1
GHN 20/40-130	979521700	50	1315 - 2456	0,17 - 0,23	230 V	H	0,05	0,4	1,1
GHN 25/40-130	979521701	50	1315 - 2456	0,17 - 0,23	230 V	H	0,05	0,4	1,1
GHN 20/60-130	979521702	90	1080 - 1980	0,17 - 0,39	230 V	H	0,05	0,4	1,1
GHN 25/60-130	979521703	90	1080 - 1980	0,17 - 0,39	230 V	H	0,05	0,4	1,1
GHN 25/65-180	979521704	95	1080 - 1980	0,19 - 0,44	230 V	H	0,05	0,4	1,1
GHN 32/65-180	979521705	95	1080 - 1980	0,19 - 0,44	230 V	H	0,05	0,4	1,1
GHN 20/65-130	979521706	95	1080 - 1980	0,19 - 0,44	230 V	H	0,05	0,4	1,1
GHN 25/65-130	979521707	95	1080 - 1980	0,19 - 0,44	230 V	H	0,05	0,4	1,1
GHN 20/40-180	979521709	50	1315 - 2456	0,17 - 0,23	230 V	H	0,05	0,4	1,1
GHN 25/40-180	979521710	50	1315 - 2456	0,17 - 0,23	230 V	H	0,05	0,4	1,1
GHN 32/40-180	979521711	50	1315 - 2456	0,17 - 0,23	230 V	H	0,05	0,4	1,1
GHN 20/60-180	979521712	90	1080 - 1980	0,17 - 0,39	230 V	H	0,05	0,4	1,1
GHN 25/60-180	979521713	90	1080 - 1980	0,17 - 0,39	230 V	H	0,05	0,4	1,1
GHN 32/60-180	979521714	90	1080 - 1980	0,17 - 0,39	230 V	H	0,05	0,4	1,1
GHN 25/70-180	979521987	140	1109 - 2340	0,39 - 0,62	230 V	H	0,05	0,4	1,1
GHN 32/70-180	979521983	140	1109 - 2340	0,39 - 0,62	230 V	H	0,05	0,4	1,1
GHN 32/75-180	979522752	265			230 V	H			
GHN 32/80-180	979521944	210	1150 - 2450	0,46 - 0,91	230 V	H	0,05	0,4	1,2
GHN 32/120-180	979522005	260	1150 - 2450	0,75 - 1,15	230 V	H	0,05	0,4	1,2
 GHND 32/70-180	979522021	270			230 V	H			
 GHND 32/80-180	979522022	393			230 V	H			
 GHND 32/120-180	979522023	509			230 V	H			
 GHN 40-120 F	979521446	580	1250 - 2820	0,34 - 1,45	3 x 400 V	H	0,05	0,8	1,4
GHN 40-70 F	979521447	320	1440 - 2790	0,22 - 0,75	3 x 400 V	H	0,05	0,8	1,4
GHN 440-40 F	979521448	200	660 - 1440	0,11 - 0,7	3 x 400 V	H	0,05	0,8	1,4
GHN 50-120 F	979521508	1060	1270 - 2800	0,46 - 1,73	3 x 400 V	H	0,3	1	1,6
GHN 50-70 F	979521509	470	560 - 1400	0,2 - 1,15	3 x 400 V	H	0,3	1	1,6
GHN 50-40 F	979521510	270	620 - 1450	0,21 - 1,0	3 x 400 V	H	0,3	1	1,6
GHN 65-120 F	979521470	1640	1250 - 2810	0,84 - 2,9	3 x 400 V	H	0,3	1	1,6
GHN 65-70 F	979521471	520	450 - 1370	0,22 - 1,2	3 x 400 V	H	0,3	1	1,6
GHN 65-40 F	979521472	360	600 - 1430	0,22 - 1,1	3 x 400 V	H	0,3	1	1,6
GHN 80-120 F	979521482	2460	1200 - 2800	1,16 - 4,2	3 x 400 V	H	0,3	1	1,6
GHN 80-70 F	979521483	1030	600 - 1350	0,42 - 2,2	3 x 400 V	H	0,3	1	1,6
GHN 80-120 F (PN10)	979521496	2200	1200 - 2800	1,16 - 4,2	3 x 400 V	H	0,3	1	1,6
GHN 80-70 F (PN10)	979521497	960	600 - 1350	0,42 - 2,2	3 x 400 V	H	0,3	1	1,6
GHN 100-120 F (PN 6)	979522756	2460			3 x 400 V	H			
 GHN 100-120 F (PN 10)	979522755	2460			3 x 400 V	H			
 GHND 40-120 F	979521452	560	1250 - 2820	0,34 - 1,45	3 x 400 V	H	0,05	0,8	1,4
GHND 40-70 F	979521453	320	1440 - 2790	0,22 - 0,75	3 x 400 V	H	0,05	0,8	1,4
GHND 40-40 F	979521454	240	660 - 1440	0,11 - 0,70	3 x 400 V	H	0,05	0,8	1,4
GHND 50-120 F	979521464	950	1270 - 2800	0,46 - 1,73	3 x 400 V	H	0,3	1	1,6
GHND 50-70 F	979521465	470	560 - 1400	0,2 - 1,15	3 x 400 V	H	0,3	1	1,6
GHND 50-40 F	979521466	340	620 - 1450	0,21 - 1,0	3 x 400 V	H	0,3	1	1,6
GHND 65-120 F	979521476	1560	1250 - 2810	0,84 - 2,9	3 x 400 V	H	0,3	1	1,6
GHND 65-70 F	979521477	600	450 - 1370	0,22 - 1,20	3 x 400 V	H	0,3	1	1,6
GHND 65-40 F	979521478	400	600 - 1430	0,22 - 1,1	3 x 400 V	H	0,3	1	1,6
GHND 80-120 F	979521488	2200	1200 - 2800	1,16 - 4,2	3 x 400 V	H	0,3	1	1,6
GHND 80-70 F	979521489	960	600 - 1350	0,42 - 2,2	3 x 400 V	H	0,3	1	1,6
GHND 80-120 F (PN10)	979521993	2200	1200 - 2800	1,16 - 4,2	3 x 400 V	H	0,3	1	1,6
GHND 80-70 F (PN10)	979521994	960	600 - 1350	0,42 - 2,2	3 x 400 V	H	0,3	1	1,6
GHNM 40/75 F 220	979522753	269			230 V	H			
GHNM 40/80 F220	979522754	197			230 V	H			

ELECTRICAL DATA / ELEKTRISCHE DATEN							MAX WORKING PRESSURE (bar) MAX ZÜLASSIGER BETRIEBSDRUCK		
pump type pumpentyp	code artikelnummer	power max. leistung- saufnahme P (W)	speed range drehzahlstufe (min-1)	FLC I nennstrom In (A)	electrical voltage elektroanschluss I (V)	insulating class isolationsklasse	temperature / temperatur		
							50°C	80°C	110°C
 GHNM 40 - 120 F	979521449	550	1270 - 2755	1,85 - 2,35	230 V	H	0,05	0,8	1,4
GHNM 40 - 70 F	979521450	290	1820 - 2690	1,15 - 1,19	230 V	H	0,05	0,8	1,4
GHNM 50 - 120 F	979521511	830	1450 - 2720	1,7 - 3,6	230 V	H	0,3	1	1,6
 GHNM 50 - 70 F	979521462	450	740 - 1260	1 - 1,85	230 V	H	0,3	1	1,6
GHNMD 40 - 120 F	979521455	550	1270 - 2755	1,85 - 2,35	230 V	H	0,05	0,8	1,4
GHNMD 40 - 70 F	979521456	290	1820 - 2690	1,15 - 1,19	230 V	H	0,05	0,8	1,4
GHNMD 50 - 120 F	979521467	830	1450 - 2720	1,7 - 3,6	230 V	H	0,3	1	1,6
GHNMD 50 - 70 F	979521468	450	740 - 1260	1 - 1,85	230 V	H	0,3	1	1,6

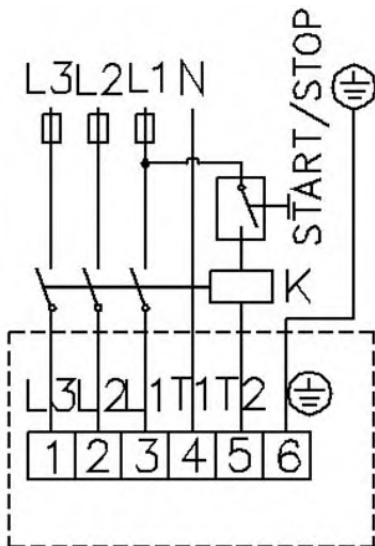
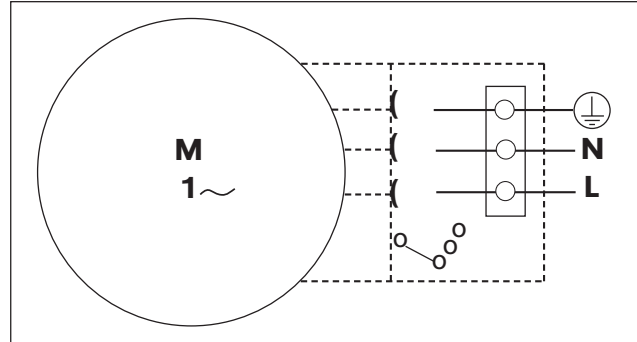

Connection and description of electric connectors:

THREE PHASE CONNECTION

Terminal 1 (LR3):

Phase L3 (T) AC power source 3-400 V/50 Hz

Terminal 2 (L2):

Phase L2 (S) AC power source 3-400 V/50 Hz

Terminal 3 (L1):

Phase L1 (R) AC power source 3-400 V/50 Hz

Terminal 4 (T1):

Neutral N AC power source 3-400 V/50 Hz

It is used to activate thermal protection.

Terminal 5 (T2):

Connection of external on/of relay.

Terminal 6:

Connect to the earth ground wire.

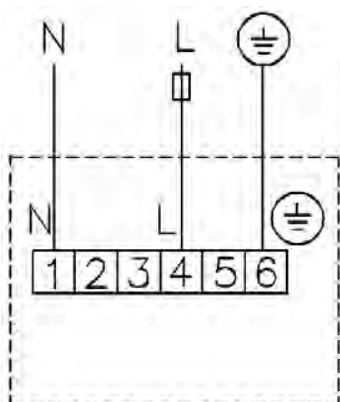

Connection and description of electric connectors:

MONO PHASE CONNECTION

Terminal 1 (N):

Neutral N AC power source 1-230 V/50 Hz

Terminal 4 (T1):

Phase L1 (R) or L2 (S) or L3 (T) AC power source 1-230 V/50 Hz

Terminal 6:

Connect to the earth ground wire.

Note:

The connection includes the thermal protection. Other connections on the terminal are used for internal use. They cannot be connected with any electrical stress.



IMPPUMPS

THE HONEST PRODUCT FOR THE HONEST PRICE

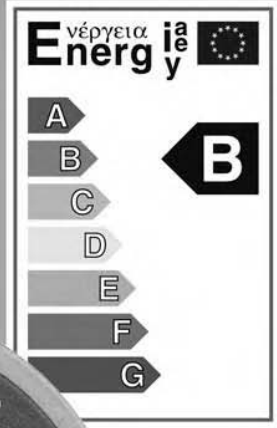

Typ:
GHN 25/40



EU
TF 110
230 V / 50 Hz
IP 44 class H
Max 10 bar

In (A)	Pi (W)
0,17	40 (1)
0,29	67 (2)
0,39	90 (3)

CIRCULATING
PUMP
UMWÄLZPUMPE

SAN

SAN



Three speeds circulating pumps for sanitary water
Dreistufige Zirkulationspumpen für Brauchwasser



Three speeds circulating pumps for sanitary water Dreistufige Zirkulationspumpen für Brauchwasser

TEHNICAL FEATURES / TECHNISCHE MERKMALE		SAN	SAN	SAN
Connections / Nennweite	DN (")	15	15, 20, 25, 32	40 do 80
Connection type / Rohranschluss		Screw Type/Gewind	Screw Type/Gewind	Flanges / Flansche
Flow max / Förderstrom max	Q (m³/h)	1,5	4/6/8	80
Pressure max / Förderhöhe	H (m)	1,5	4/6/7/8	12
Pressure rated / Betriebsdruck	PN (bar)	6	10	6 / 10
Power max / Leistungsaufnahme max	P (W)	25	90	2200
Electrical voltage / Elektroanschluss	V	1 x 230 AC	1 x 230 AC	3 x 400 AC
Degree of protection / Schutzart	IP	42	44	43
Regulation / Regelung		yes / ja	no / nein	no / nein
Media temperature / Temperaturbereich	T(°C)	+5 do +70	+5 do +65	-10 do +65
Insulating class / Isolationsklasse		H	H	H
Casing type / Werkstoffe		bronz / bronze	bronz / bronze	bronz / bronze
Duble pump / Zwillingspumpe		no / nein	no / nein	no / nein
APPLICATIONS / EINSATZGEBIETE				
Heating / Warmwasserheizungen		✓	✓	✓
Cooling / Kaltwasseranlagen		✓	✓	✓
Sanitary water / Brauchwasser				
Climate appliances / Klimaanlage		✓	✓	✓
Industry / Industrieanlagen		✓	✓	✓
Process technique / Verfahrenstechnik				
Condensation / Kondensat				
Salt water / Meerwasser				

Pump markings / Typenschlüssel

SAN 25 / 60 - 130 (180)

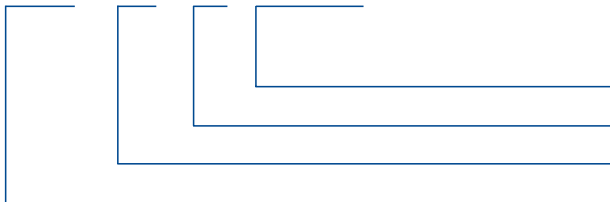

instalation lenght / einbaulänge
max head / förderhöhe
connection size / nennweite **DN**
circulating pump / Umwälzpumpe

SAN 40 - 120 F

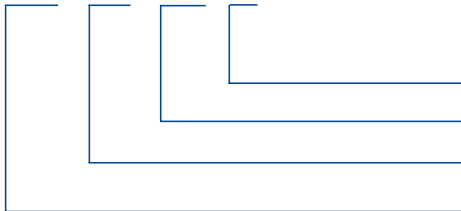

connection type - **Flange** / Rohranschluss - **Flansche**
max head / förderhöhe
connection size **DN** / nennweite **DN**
pump type / pumpentyp

Permitted mounting positions / Einbaumöglichkeiten



Threaded three speeds circulation pumps for sanitary water
Dreistufige Verschraubungsumwälzpumpen mit manueller
Drehzahlumschaltung

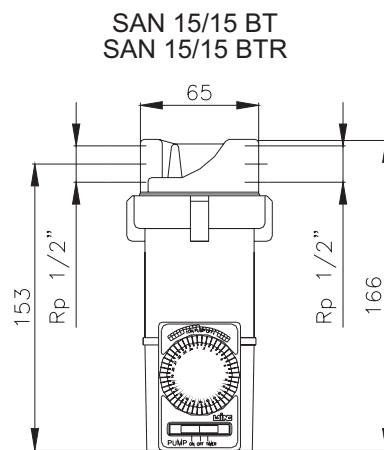
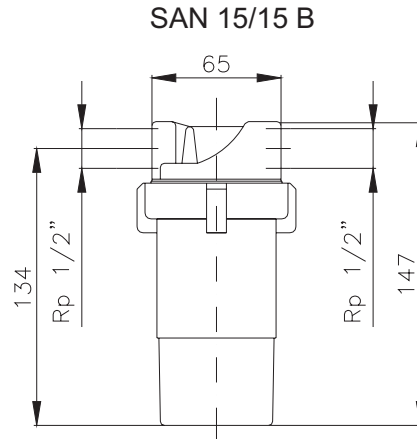

Threaded circulation pumps with three speeds for sanitary water
Dreistufige Verschraubungsumwälzpumpen mit manueller
Drehzahlumschaltung

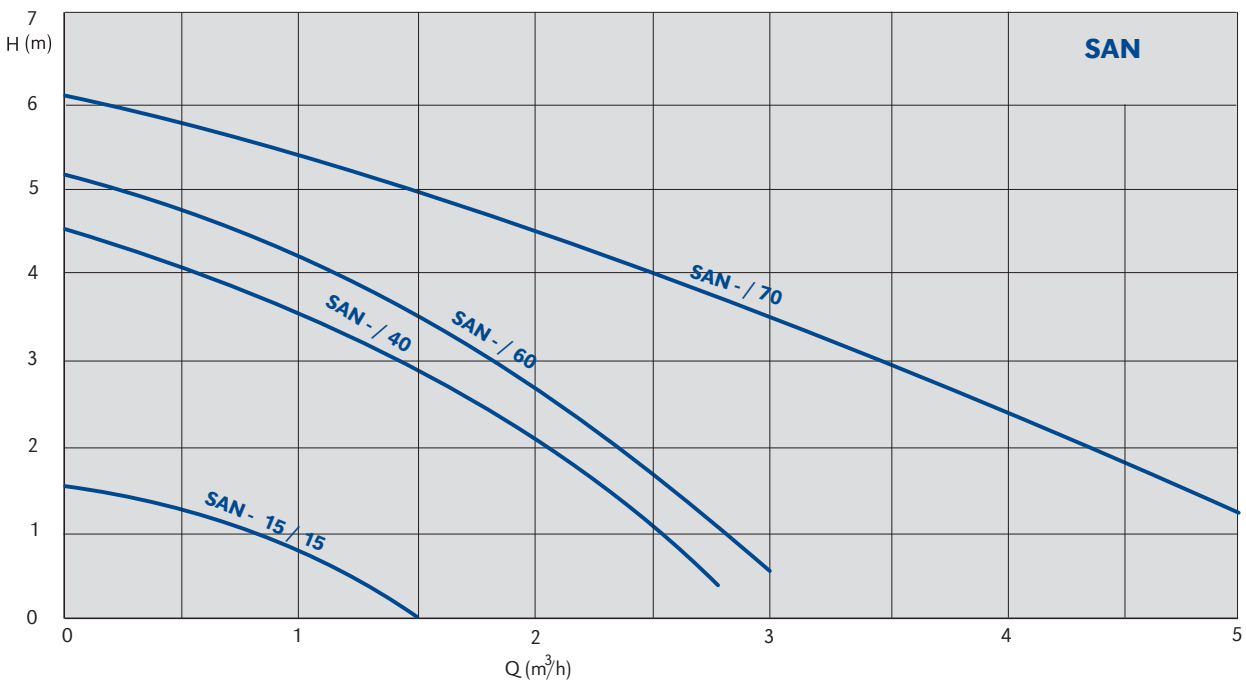
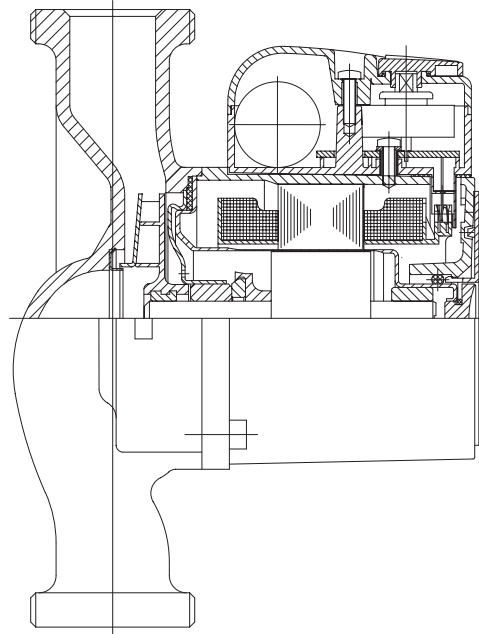

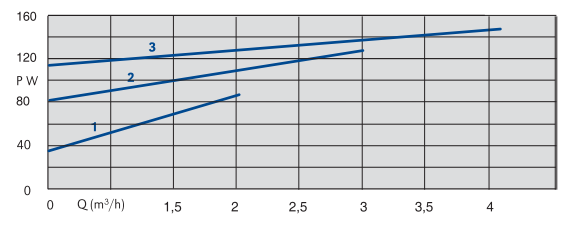
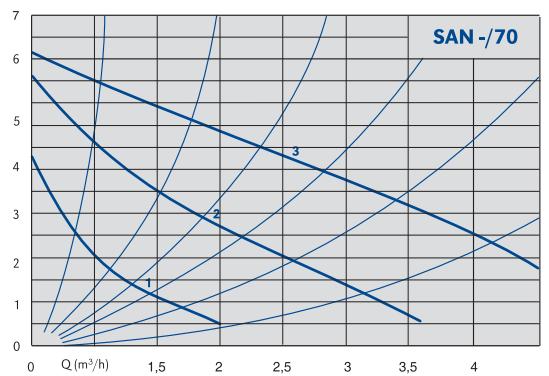
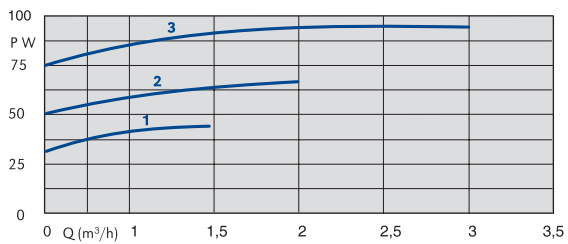
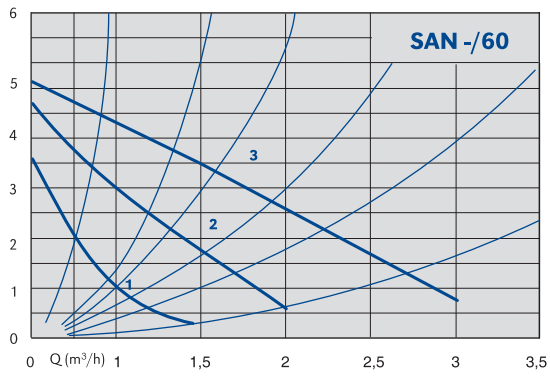
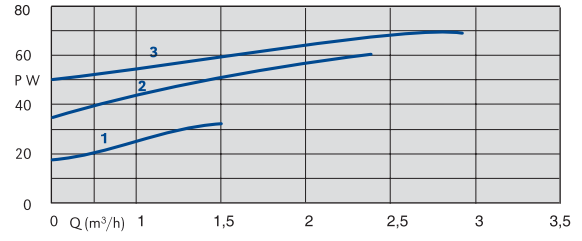
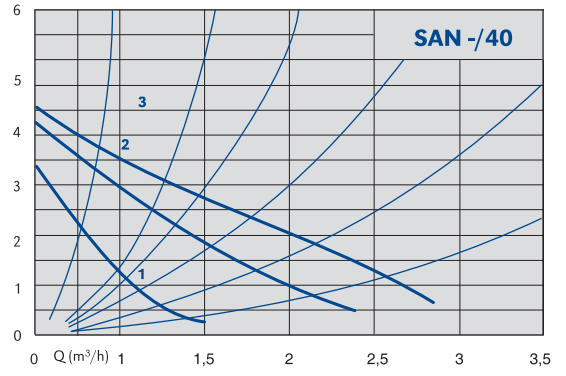
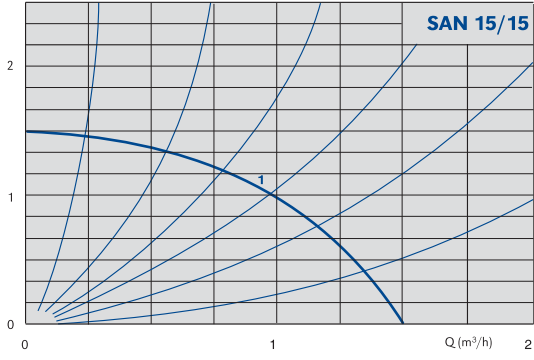

Three speeds circulation pumps for sanitary water with flanges
Dreistufige Flanschumwälzpumpen mit manueller
Drehzahlumschaltung für Brauchwasser

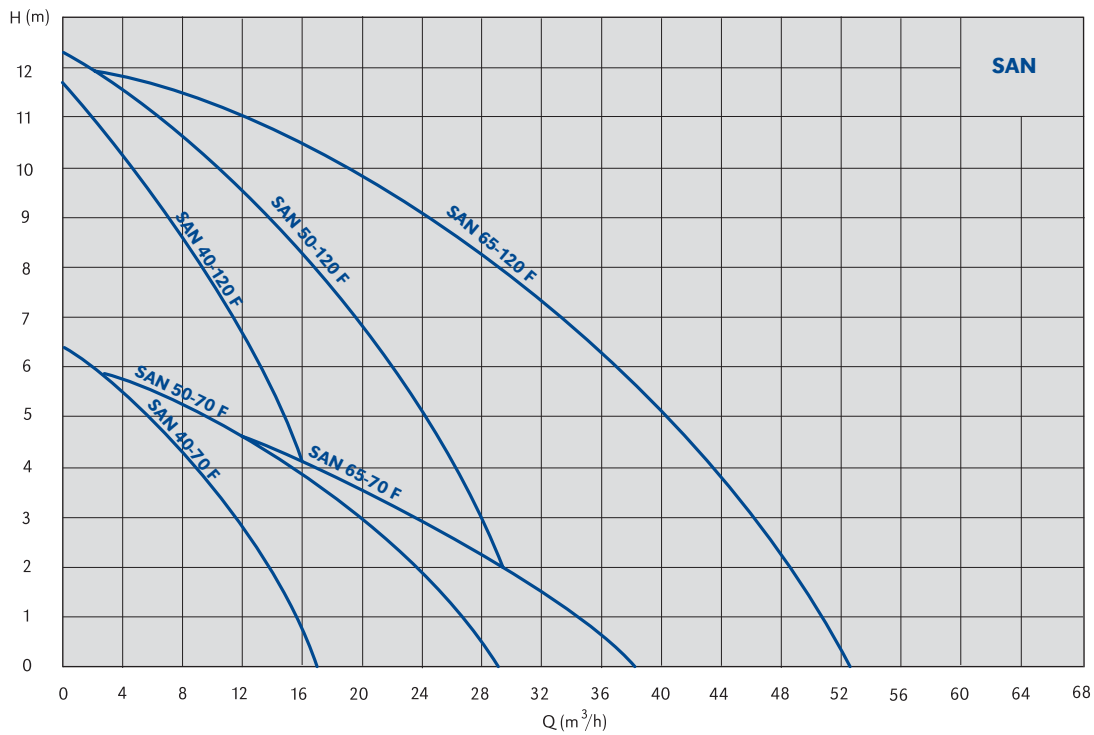
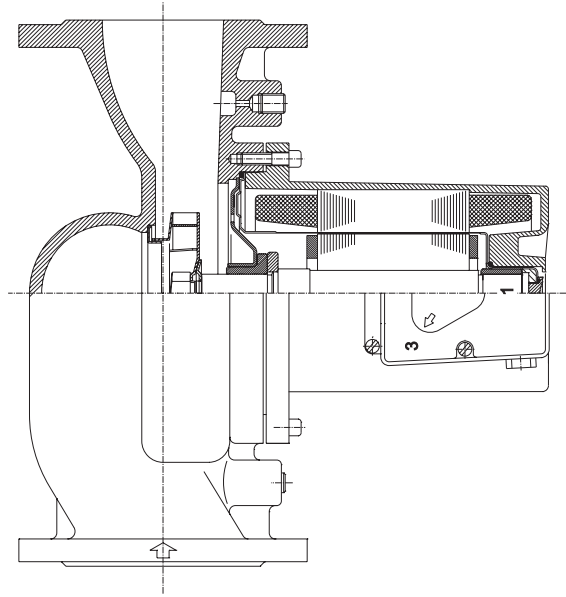
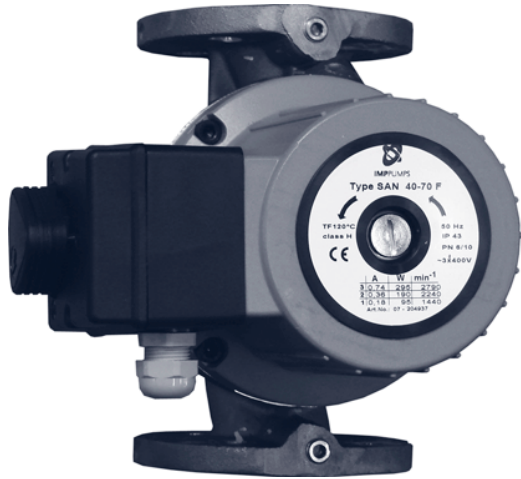

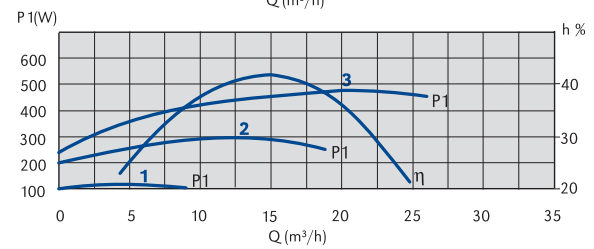
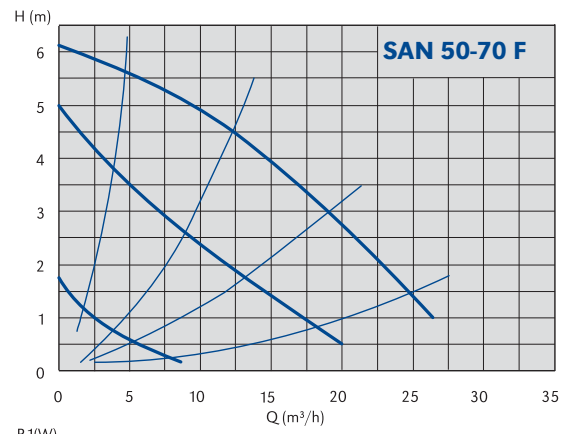
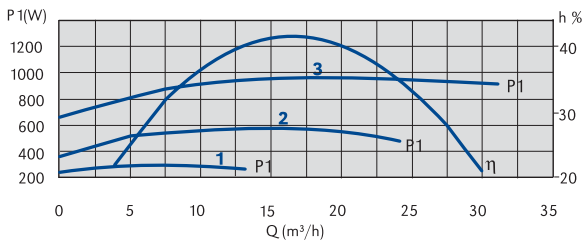
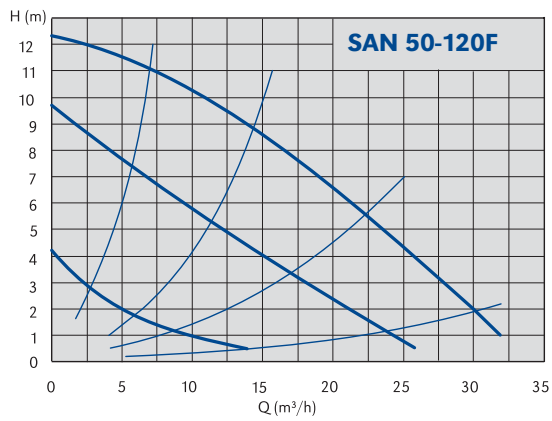
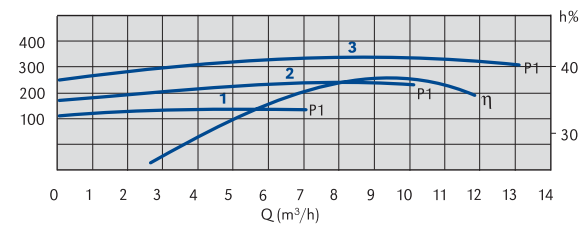
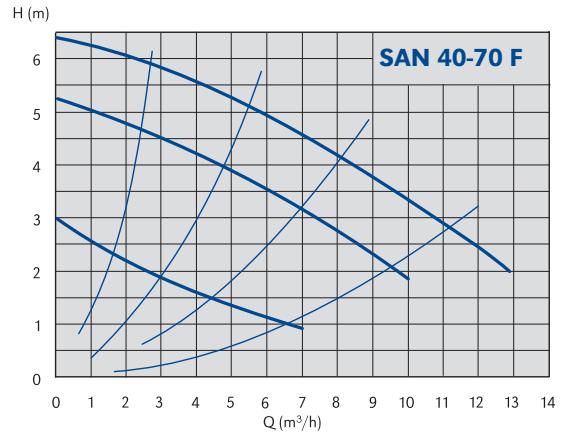
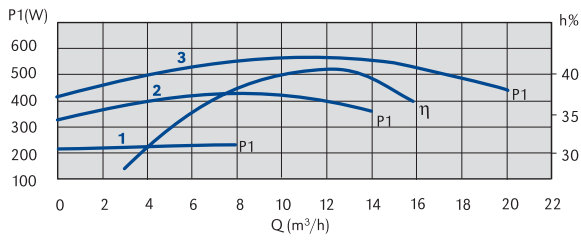
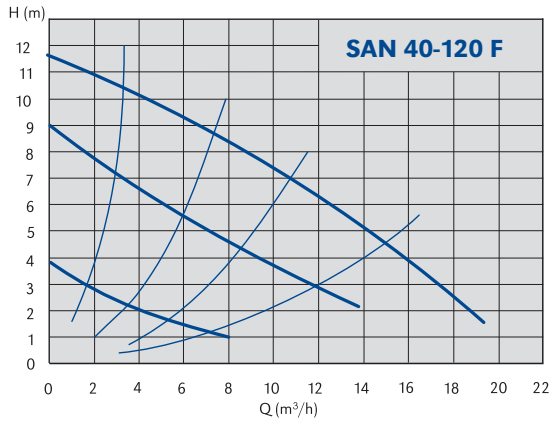

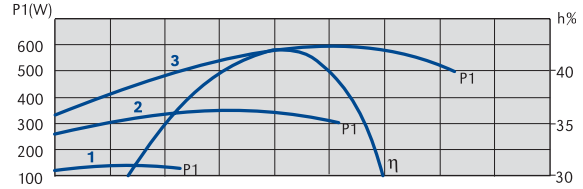
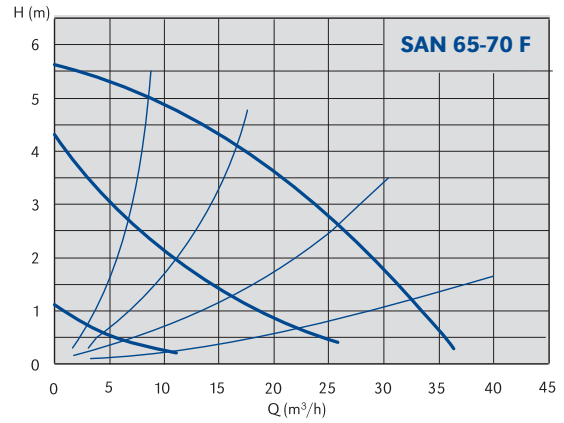
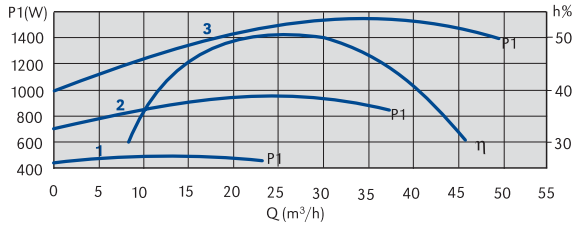
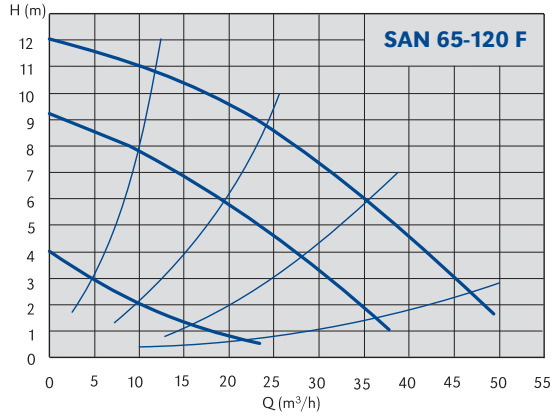

TEHNIICAL DATA / TECHNISCHE DATEN

pump type pumpentyp	code artikelnnummer	connection type rohranschluss	max. flow durchfluss Q (m³/h)	max. Head Förder- höhe H (m)	system pressure systemdruck PN (bar)	min. - max. media temperature temp. des medius Tmin-Tmax (°C)	casing type werkstoffe	single-S double-D einzelne-E zwillings- bauform-Z	weight gewicht (kg)	regulation geregelt yes /ja no /nein	degree of protection schutzart IP
SAN 15/15 B	L-1000001	Screw/Gewinde	1,5	1,5	PN 6	+5 - 70	bronze	S/E	1,2	no/nein	42
SAN 15/15 BT	L-1000020	Screw/Gewinde	1,5	1,5	PN 6	+5 - 70	bronze	S/E	1,4	yes/ja	42
SAN 15/15 BTR	L-1000035	Screw/Gewinde	1,5	1,5	PN 6	+5 - 70	bronze	S/E	1,4	yes/ja	42
SAN 15/40-130	979521765	Screw/Gewinde	2,8	4,5	PN 10	+5 - 65	bronze	S/E	2,3	no/nein	44
SAN 20/40-130	979521766	Screw/Gewinde	2,8	4,5	PN 10	+5 - 65	bronze	S/E	2,4	no/nein	44
SAN 25/40-130	979521767	Screw/Gewinde	2,8	4,5	PN 10	+5 - 65	bronze	S/E	2,4	no/nein	44
SAN 15/60-130	979521768	Screw/Gewinde	3	5,1	PN 10	+5 - 65	bronze	S/E	2,5	no/nein	44
SAN 20/60-130	979521769	Screw/Gewinde	3	5,1	PN 10	+5 - 65	bronze	S/E	2,6	no/nein	44
SAN 25/60-130	979521770	Screw/Gewinde	3	5,1	PN 10	+5 - 65	bronze	S/E	2,6	no/nein	44
SAN 20/70-130	979522018	Screw/Gewinde	5,2	6,2	PN 10	+5 - 65	bronze	S/E	3,8	no/nein	44
SAN 25/70-130	979522006	Screw/Gewinde	5,2	6,2	PN 10	+5 - 65	bronze	S/E	3,8	no/nein	44
SAN 40-120 F	979521906	Flanges/Flansche	20	12	PN 6 / 10	-10 - +65	bronze	S/E	22	no/nein	43
SAN 40-70 F	979521907	Flanges/Flansche	13	6	PN 6 / 10	-10 - +65	bronze	S/E	22	no/nein	43
SAN 50-120 F	979521908	Flanges/Flansche	30	12	PN 6 / 10	-10 - +65	bronze	S/E	28	no/nein	43
SAN 50-70 F	979521909	Flanges/Flansche	25	6	PN 6 / 10	-10 - +65	bronze	S/E	28	no/nein	43
SAN 65-120 F	979521910	Flanges/Flansche	50	12	PN 6 / 10	-10 - +65	bronze	S/E	36	no/nein	43
SAN 65-70 F	979521911	Flanges/Flansche	35	6	PN 6 / 10	-10 - +65	bronze	S/E	36	no/nein	43

DIMENSIONS / MAßE

	pump type pumpentyp	code artikelnummer	length einbaulänge L (mm)	connection size rohranschluss DN	a	l	b1	b2	R	b	h1
1	SAN 15/15 B	L-1000001	65	DN 15	13	134	33	33			
	SAN 15/15 BT	L-1000020	65	DN 15	13	153	33	33			
	SAN 15/15 BTR	L-1000035	65	DN 15	13	153	33	33			
	SAN 15/40-130	979521765	130	DN 15	28	108	80	44			
	SAN 20/40-130	979521766	130	DN 20	28	108	80	44			
	SAN 25/40-130	979521767	130	DN 25	28	108	80	44			
	SAN 15/60-130	979521768	130	DN 15	28	108	80	44			
	SAN 20/60-130	979521769	130	DN 20	28	108	80	44			
	SAN 25/60-130	979521770	130	DN 25	28	108	80	44			
	SAN 20/70-130	979522018	130	DN 20	28	108	80	44			
	SAN 25/70-130	979522006	130	DN 25	30	108	80	44			
2	SAN 40-120 F	979521906	250	DN 40	65	198	153	92			
	SAN 40-70 F	979521907	250	DN 40	65	198	153	92			
	SAN 50-120 F	979521908	280	DN 50	70	250	160	113			
	SAN 50-70 F	979521909	280	DN 50	70	250	160	113			
	SAN 65-120 F	979521910	340	DN 65	80	252	160	123			
	SAN 65-70 F	979521911	340	DN 65	80	252	160	123			

ELECTRICAL DATA / ELEKTRISCHE DATEN

MAX WORKING PRESSURE (bar)
MAX ZÜSSLASSIGER BETRIEBSDRUCK

	pump type pumpentyp	code artikelnummer	power max. leistung- aufnahme P (W)	speed range drehzahlstufe (min-1)	FLC I nennstrom In (A)	electrical voltage elektroanschluss l (V)	insulating class isoliationsklasse	temperature / temperatur		
								50°C	80°C	110°C
1	SAN 15/15 B	L-1000001	25		0,11	230 V	F			
	SAN 15/15 BT	L-1000020	25		0,11	230 V	F			
	SAN 15/15 BTR	L-1000035	25		0,11	230 V	F			
	SAN 15/40-130	979521765	66	1315 - 2456	0,16 - 0,23	230 V	H	0,05	0,4	1,1
	SAN 20/40-130	979521766	66	1315 - 2456	0,16 - 0,23	230 V	H	0,05	0,4	1,1
	SAN 25/40-130	979521767	66	1315 - 2456	0,16 - 0,23	230 V	H	0,05	0,4	1,1
	SAN 15/60-130	979521768	90	1080 - 1980	0,17 - 0,39	230 V	H	0,05	0,4	1,1
	SAN 20/60-130	979521769	90	1080 - 1980	0,17 - 0,39	230 V	H	0,05	0,4	1,1
	SAN 25/60-130	979521770	90	1080 - 1980	0,17 - 0,39	230 V	H	0,05	0,4	1,1
	SAN 20/70-130	979522018	139	1109 - 2340	0,39 - 0,62	230 V	H	0,05	0,4	1,1
	SAN 25/70-130	979522006	139	1109 - 2340	0,39 - 0,62	230 V	H	0,05	0,4	1,2
2	SAN 40-120 F	979521906	560	1250 - 2820	0,26 - 1,16	3 x 400 V	H	0,05	0,8	1,4
	SAN 40-70 F	979521907	320	1440 - 2790	0,18 - 0,74	3 x 400 V	H	0,05	0,8	1,4
	SAN 50-120 F	979521908	950	1270 - 2800	0,46 - 1,73	3 x 400 V	H	0,05	0,8	1,4
	SAN 50-70 F	979521909	470	560 - 1400	0,2 - 1,15	3 x 400 V	H	0,3	1	1,6
	SAN 65-120 F	979521910	1560	1250 - 2810	0,84 - 2,8	3 x 400 V	H	0,3	1	1,6
	SAN 65-70 F	979521911	600	450 - 1370	0,22 - 1,25	3 x 400 V	H	0,3	1	1,6

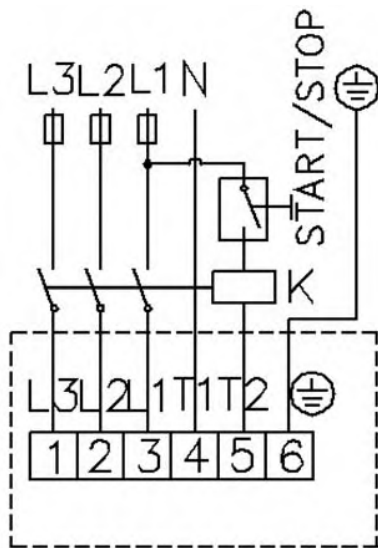
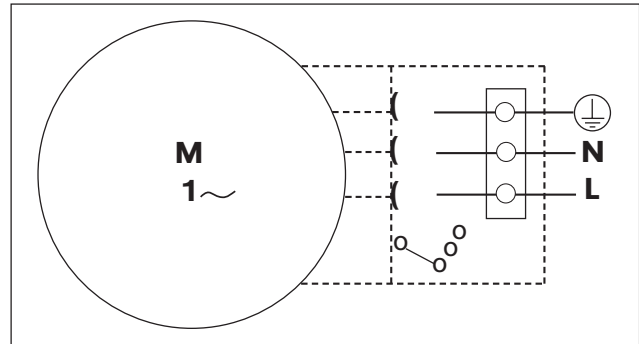
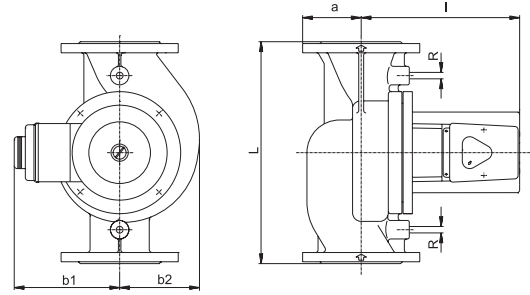
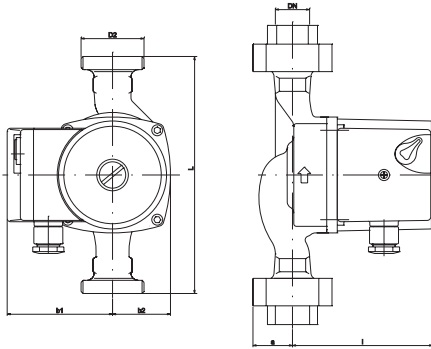

Connection and description of electric connectors:

THREE PHASE CONNECTION

Terminal 1 (LR3):

Phase L3 (T) AC power source 3-400 V/50 Hz

Terminal 2 (L2):

Phase L2 (S) AC power source 3-400 V/50 Hz

Terminal 3 (L1):

Phase L1 (R) AC power source 3-400 V/50 Hz

Terminal 4 (T1):

Neutral N AC power source 3-400 V/50 Hz
It is used to activate thermal protection.

Terminal 5 (T2):

Connection of external on/of relay.

Terminal 6:

Connect to the earth ground wire.

ECL

ECL



Electronically controlled in-line pumps /
Elektronisch geregelte Trockenläuferpumpen



Electronically controlled in-line pumps Elektronisch geregelte Trockenläuferpumpen

ADVANTAGES AND CLARIFICATIONS FOR INSTALLING ELECTRONICALLY REGULATED PUMPS

Saving of energy and money

Due to their regulation of revolutions per minute and power of the motor, electronically regulated pumps attain significantly better conditions of investing energy and work - compared with non-regulated pumps they save on electricity and money.

Optimal adaptation of variables required by the hydraulic system

A wide set-up of hydraulic parameters enables optimal adaptation of the pump to the requirements of the heating system and minimum consumption of electricity.

Noiseless and peaceful operation

The system with electronically regulated pumps runs noiselessly even in the event of heating with thermostatic valves. Due to adapting variables in the system, regulated pumps provide optimal hydraulic balance in the system in all conditions.

Operational safety

Electronically regulated pumps are protected against overloading, short circuits, excessive voltage and excessive temperature.

Reducing environmental pollution

Due to the efficient use of electrical energy, electronically regulated pumps are less burdensome to the environment.

Simplifying projects and reducing costs of mechanical installation

Electronically regulated pumps simplify making projects and the design of mechanical installation.

In some countries the government has legislated to take into account these advantages. For example the German decree of 1994 on heating appliances prescribes circulation pumps for boilers over 50 kW must have at least a three-stage automatic regulation.

VORTEILE UND GRÜNDE FÜR DEN EINBAU ELEKTRONISCH REGULIERTER PUMPEN

Einsparung von Energie und Geld

Die elektronisch regulierten Pumpen erreichen wegen ihrer selbsttätigen Regulierung der Drehzahl und der Motorleistung ein wesentlich besseres Verhältnis zwischen eingebrachter Energie und verrichteter Arbeit, im Vergleich mit nicht regulierten Pumpen ermöglichen sie eine große Einsparung an elektrischer Energie und Geld.

Optimale Anpassung an veränderliche Erfordernisse des hydraulischen Systems

Das weite Feld der Einstellung der hydraulischen Parameter ermöglicht eine optimale Anpassung der Pumpe an die Erfordernisse des Heizsystems bei minimalem Stromverbrauch.

Geräuschloses und ruhiges Funktionieren

Das System mit elektronisch regulierten Pumpen arbeitet geräuschlos auch bei Heizkörpern mit angebauten Thermostatventil. Aufgrund der Anpassung an Veränderungen im System gewährleisten regulierte Pumpen bei allen Verhältnissen ein optimales hydraulisches Gleichgewicht im System.

Funktionsschutz

Elektronisch regulierte Pumpen sind gegen Überlastung, Kurzschluss, Überspannung und gegen zu hohe Temperaturen geschützt.

Verringerung der Umweltverschmutzung

Aufgrund der hohen Auslastung der eingebrachten Energie wird die Umwelt durch elektronisch regulierte Pumpen weniger belastet.

Vereinfachung der Projektierung und Kostenverringerung der Maschineninstallation

Elektronisch regulierte Pumpen vereinfachen dem Projektanten das Projektieren und auch die Ausführung der Maschineninstallation selbst ist einfacher. Diese Vorteile wurden in einigen Staaten auch von den Regierungen berücksichtigt und eine entsprechende Gesetzgebung vorbereitet.

Electronically controlled in-line pumps Elektronisch geregelte Trockenläuferpumpen

ELECTRONICALLY REGULATED PUMPS ECL

The ECL electronically regulated pumps provide various media flows in equal or lower heights in changing hydraulic resistances in the system. Changing resistance in the system is normally linked to the operation of hydraulic valves - these changes are recognised by a special pump sensor. A special algorithm in the electronically regulated pump then raises or lowers the rpm of the pump motor with respect to changes in resistance at constant or proportional pressure. Automatic operation of the pump is therefore achieved by setting the pressure for various resistances in the closed loop system of central heating.

ECL pumps with separate frequency converter

The ECL pump with separate frequency converter comprises pump, pressure difference measurer (built into the pump) and separately installed frequency converter (placed on the wall inside or outside the room with the pump). This pump can perform the following functions:

Automatic regulation of constant pressure difference

The automatic regulation of constant Δp_C is used in dual-pipe systems with thermostatic valves and large user influence such as:

- Devices with working point at low pressure difference
- Devices with strongly choked valves of raised pipes
- Devices with low pressure drops in parts of the system with joint flow (boilers, heat exchangers, joint networks)

Operation by maximum curve

Operation by maximum curve is the same as the operation of a non-regulated pump at the highest speed. This method is used in attempting to start a device or in the event of regulation breakdown.

Connection of the ECL pump to the electricity grid

All types of ECL pump have series three-phase connection of frequency converter to the electricity grid.

So schreibt die deutsche Verordnung für Heizanlagen aus dem Jahre 1994 vor, dass Umlaufpumpen bei einer Kesselleistung von über 50 kW mit mindestens dreistufigen selbstständigen Regulationen ausgestattet sein müssen.

ELEKTRONISCH REGULIERTE PUMPEN ECL

Die elektronisch regulierten Pumpen ECL gewährleisten verschiedene Durchflüsse von Medien bei gleicher oder niedriger Druckhöhe bei veränderlichen hydraulischen Widerständen im System. Widerstandsveränderungen im System sind in der Regel mit dem Funktionieren der Thermostatventile verbunden - diese Veränderungen nimmt ein spezieller Fühler der Pumpe wahr. Abhängig von der Widerstandsveränderung im System erhöht oder verringert danach ein besonderer Algorithmus in der Steuerelektronik der Pumpe die Anzahl der Umdrehungen im Pumpenmotor bei konstantem oder proportionalem Druck. Dadurch erreichen wir das selbstständige Funktionieren der Pumpen bei eingestelltem Druck für verschiedene Widerstände im geschlossenen Kreis des Zentralheizungssystems.

ECL Pumpen mit getrenntem Frequenzumspanner

Die Ausführung der ECL Pumpe mit getrenntem Frequenzumspanner besteht aus der Pumpe, dem Druckunterschiedsmesser (angebaut an der Pumpe) und dem getrennt angebrachten Frequenzumspanner (angebracht an der Wand des Raumes, in dem sich die Pumpe befindet oder außerhalb des Raumes). Diese Pumpen erfüllen folgende Funktionen:

Selbstständige Regulierung des konstanten Druckunterschiedes

Selbstständige Regulierung des konstanten Δp_C wird angewandt bei doppelläufigen Systemen mit Thermostatventilen sowie bei großen autoritären Verbrauchern, wie:

- Anlagen mit einem Arbeitspunkt bei niedrigem Druckunterschied,
- Anlagen mit starken Drosselventilen für Steigleitungen
- Anlagen mit niedrigem Druckabfall in Systemteilen mit einem gemeinsamen Umspanner (Kessel, Wärmeaustauscher, gemeinsames Netz).

Electronically controlled in-line pumps Elektronisch geregelte Trockenläuferpumpen

Funktionieren gemäß minimaler Kurve

Das Funktionieren gemäß der minimalen Kurve entspricht dem Funktionieren bei niedrigster Geschwindigkeit. Diese Art wird angewandt bei nächtlicher Verringerung der Heizleistung, bei Bedarfsverringern an Wochenenden oder in Urlaubszeiten (in Schulen, in Institutionen...). Es wird mithilfe einer Schaltuhr eingeschaltet.

Anschluss der ECL Pumpen an das Stromnetz

Alle Typen der ECL Pumpen verfügen über einen serienmäßigen Dreiphasenanschluss des Frequenzumspanner an das Stromnetz.

Electronically controlled in-line pumps Elektronisch geregelte Trockenläuferpumpen

TEHNICAL FEATURES / TECHNISCHE MERKMALE		ECL
Connections / Nennweite	DN (")	32 do 100
Connection type / Rohranschluss		Flanges / Flansche
Flow max / Förderstrom max	Q (m ³ /h)	160
Pressure max / Förderhöhe	H (m)	60
Pressure rated / Betriebsdruck	PN (bar)	8 / 10
Power max / Leistungsaufnahme max	P (W)	22000
Electrical voltage / Elektroanschluss	V	3 x 400 AC
Degree of protection / Schutzart	IP	54
Regulation / Regelung		no / nein
Media temperature / Temperaturbereich	T(°C)	-15 do +140
Insulating class / Isolationsklasse		E
Casing type / Werkstoffe		GG / Cast iron
Duble pump / Zwillingspumpe		no / nein
APPLICATIONS / EINSATZGEBIETE		
Heating / Warmwasserheizungen		✓
Cooling / Kaltwasseranlagen		✓
Sanitary water / Brauchwasser		
Climate appliances / Klimaanlage		✓
Industry / Industrieanlagen		✓
Process technique / Verfahrenstechnik		✓
Condensation / Kondensat		✓
Salt water / Meerwasser		

Pump markings / Typenschlüssel

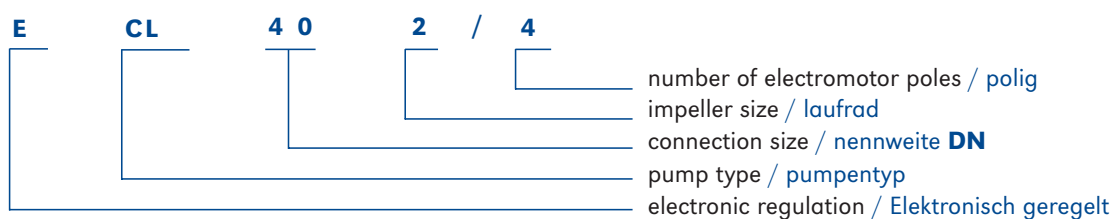

Permitted mounting positions / Einbaumöglichkeiten

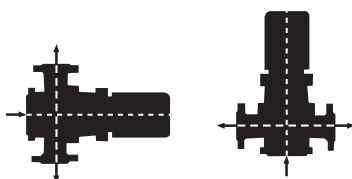

In-line pumps with separate frequency converter
Elektronisch geregelte Inlinepumpen mit integrierter Differenzdruckregelung
mit abwickelbar Frequenzumformer

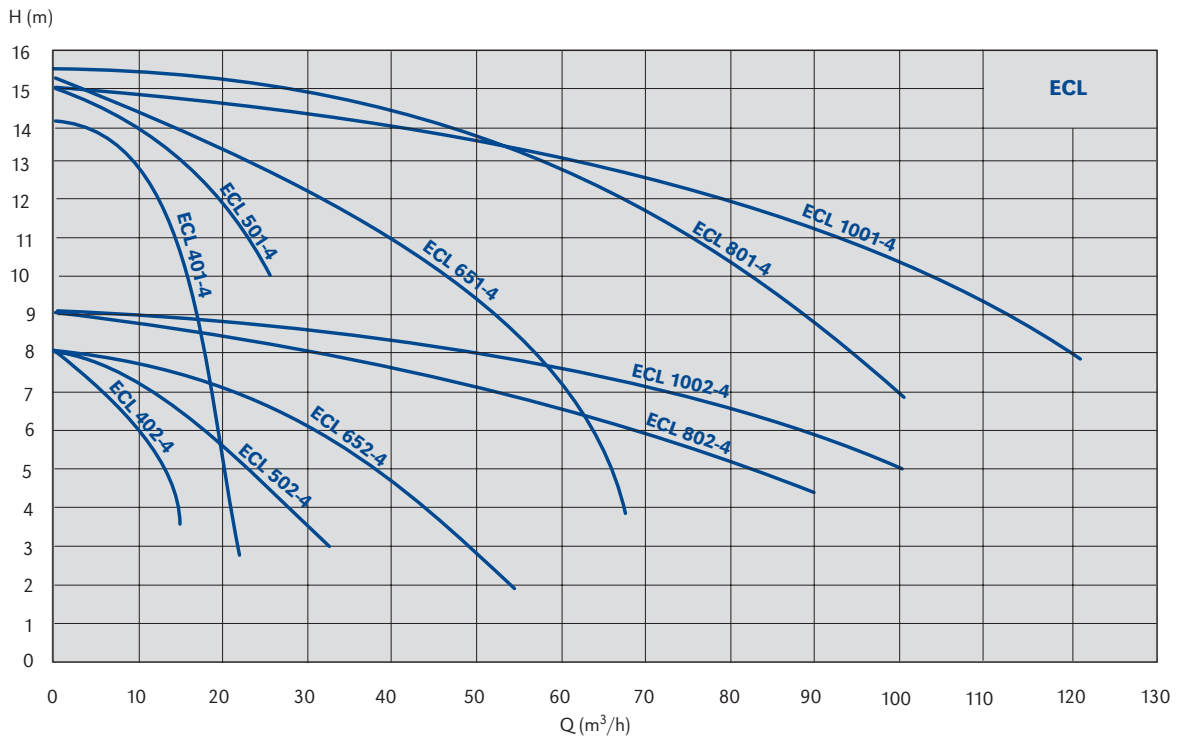
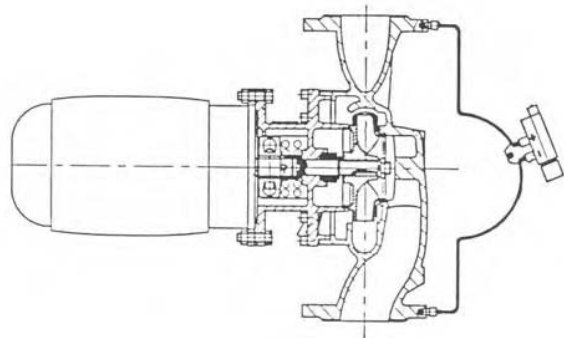
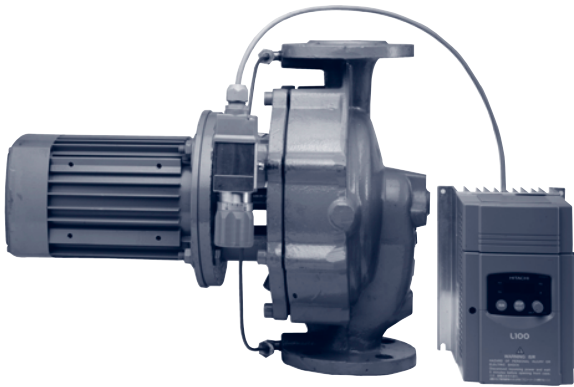

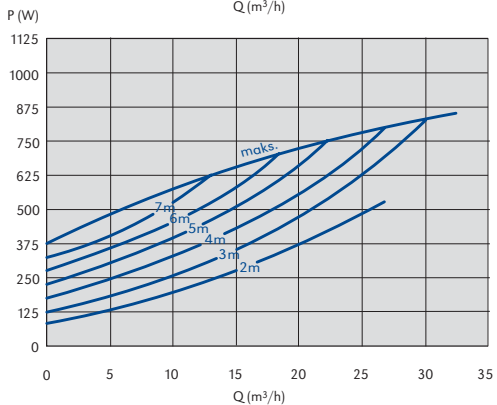
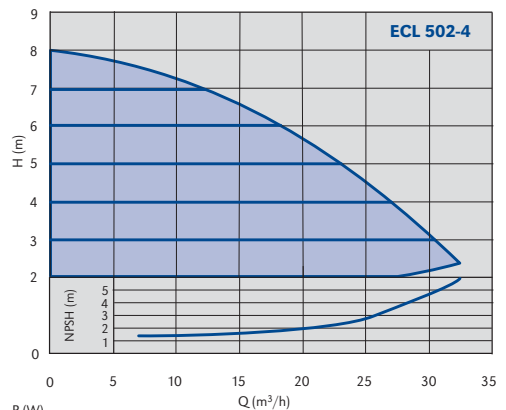
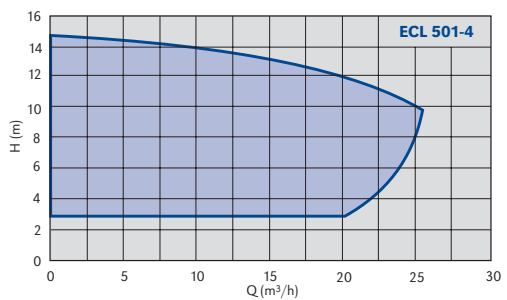
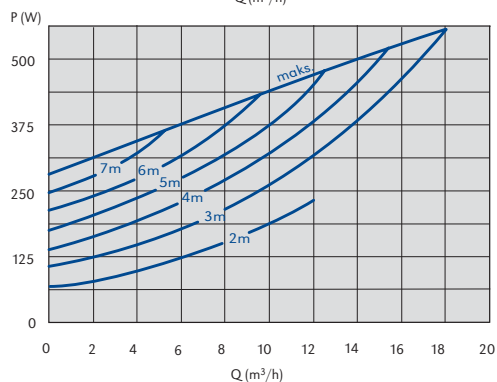
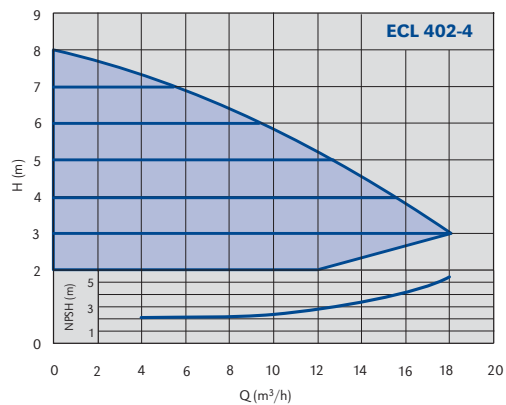
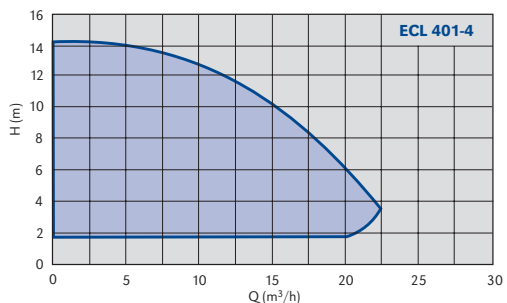

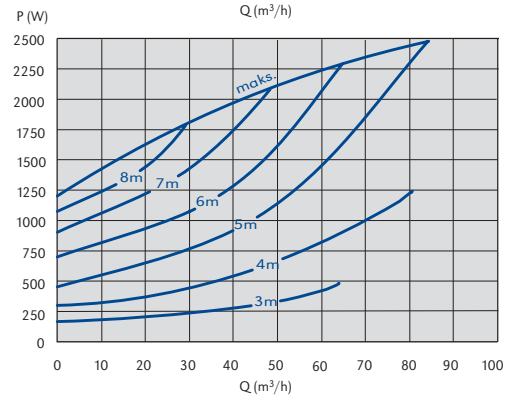
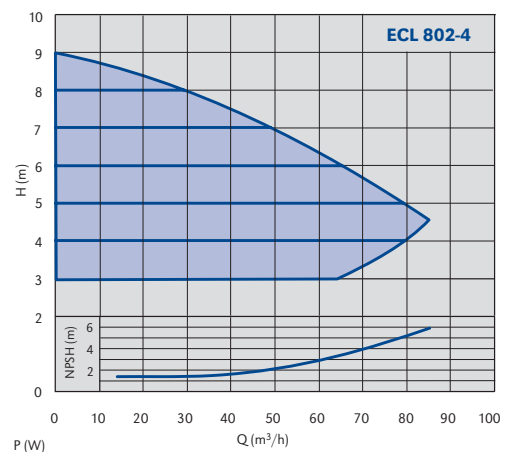
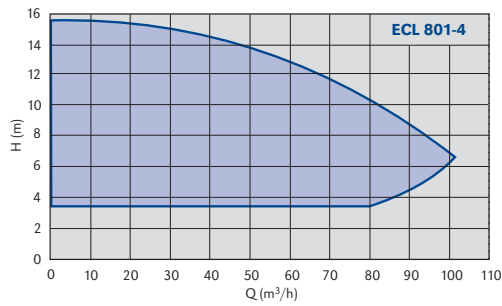
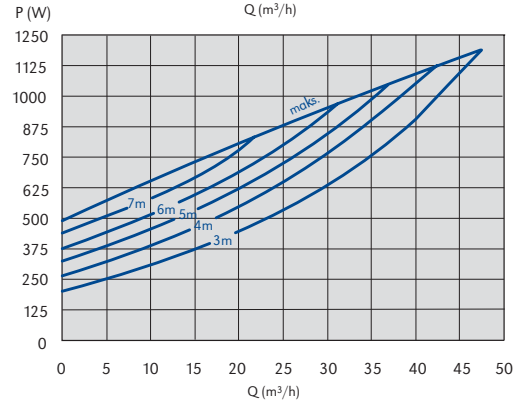
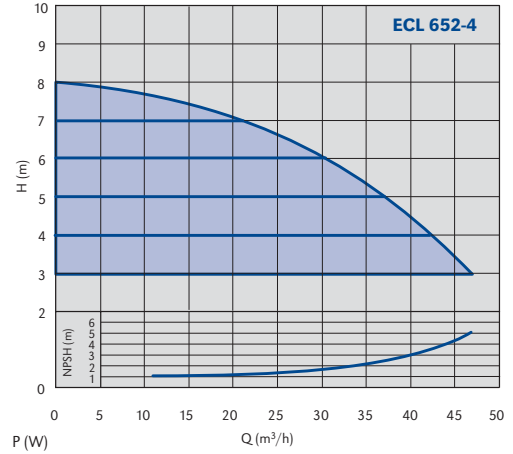
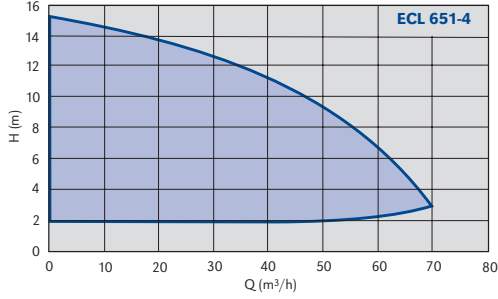

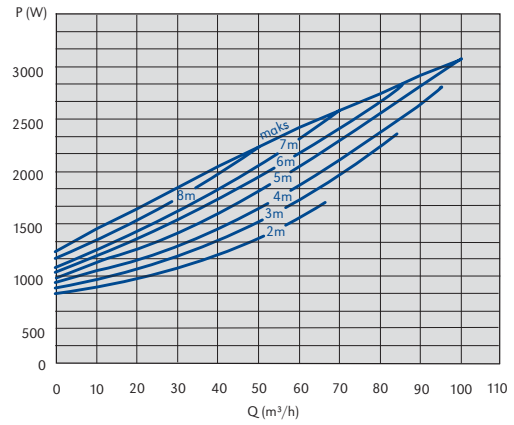
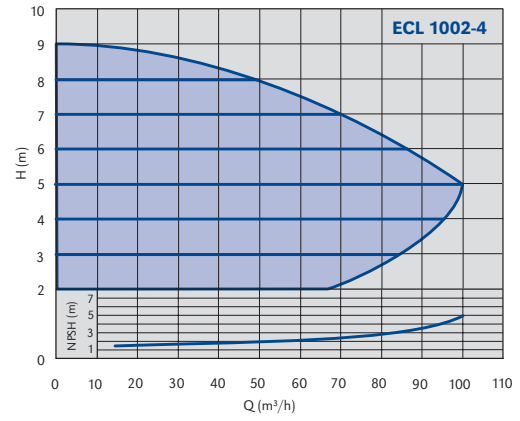
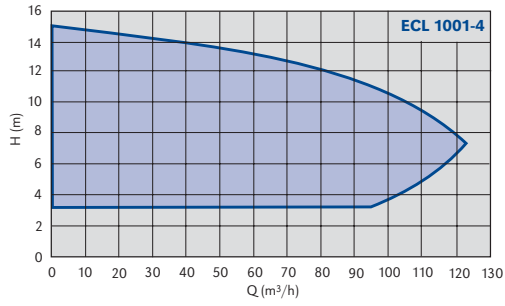

In-line pumps with separate frequency converter
Elektronisch geregelte Inlinepumpen mit integrierter Differenzdruckregelung
mit abwickelbar Frequenzumformer

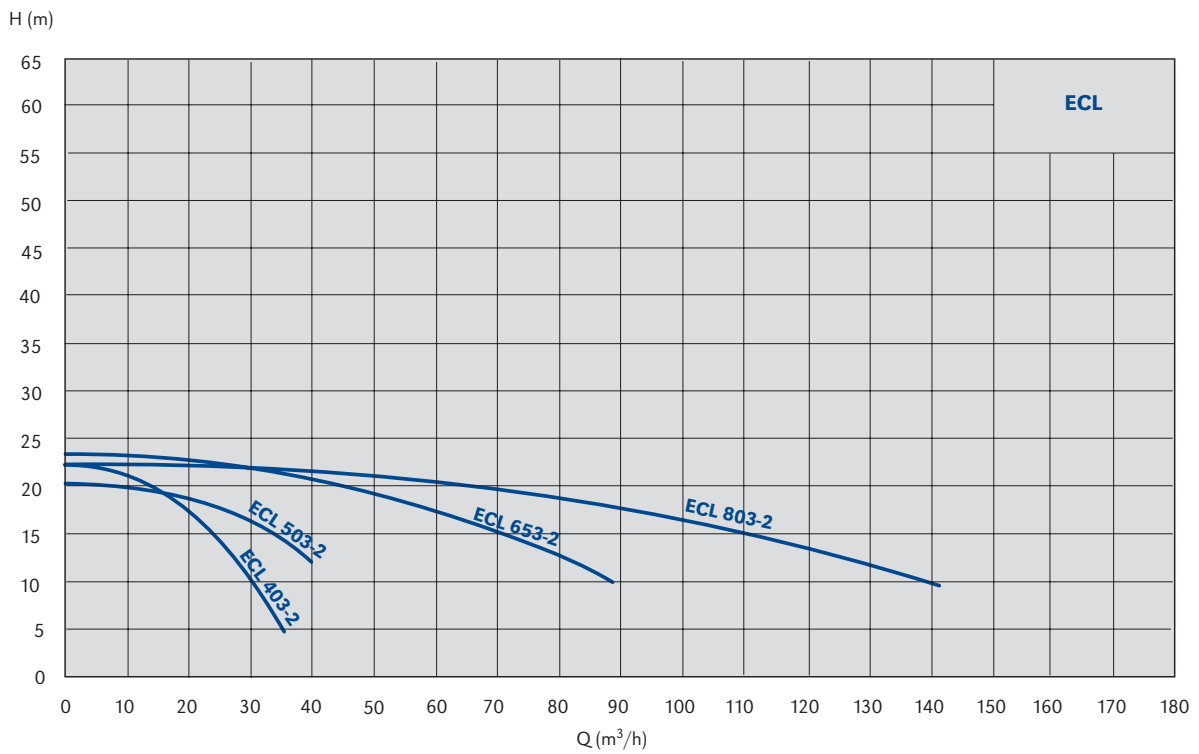
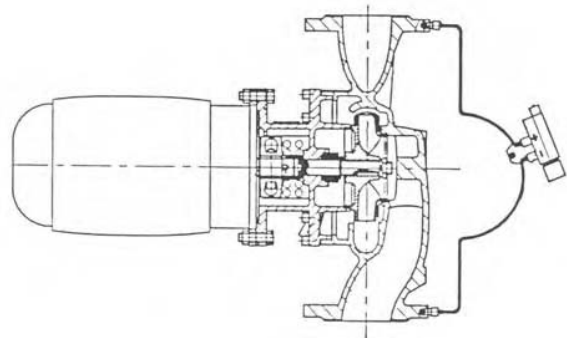
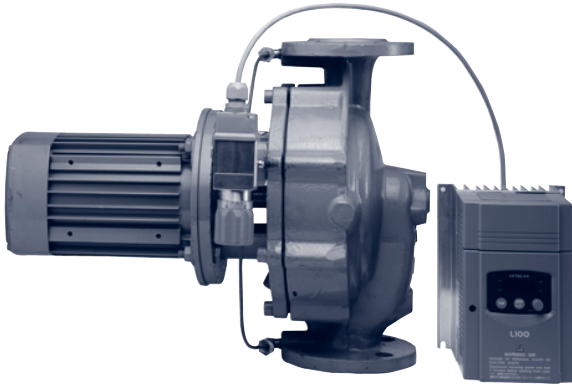

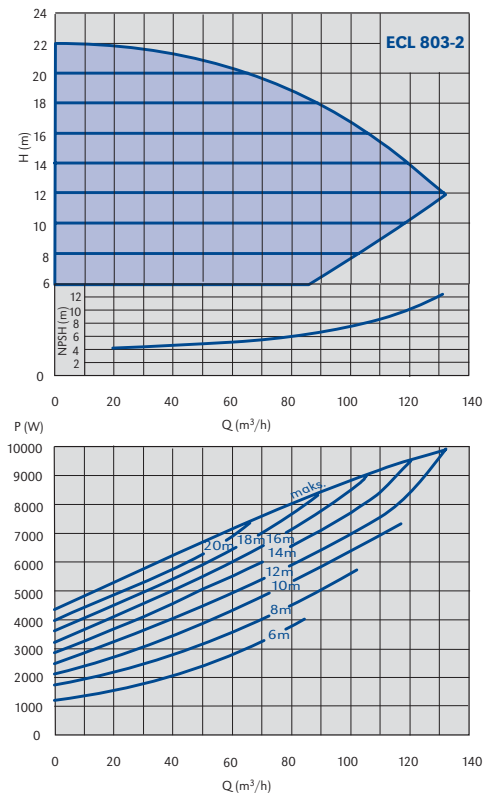
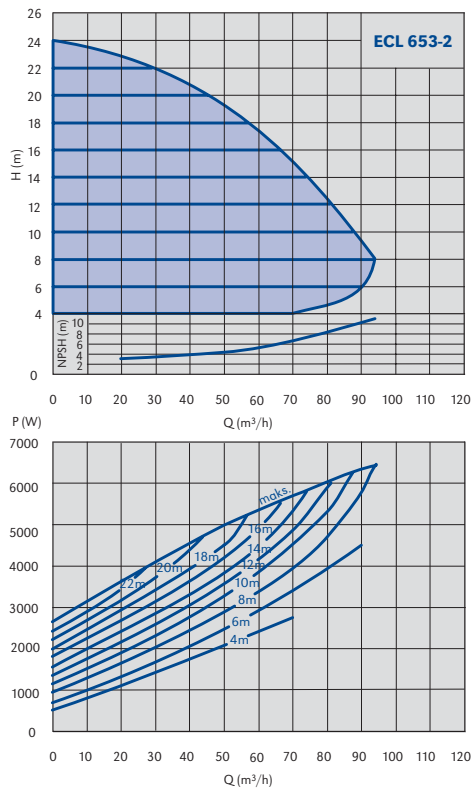
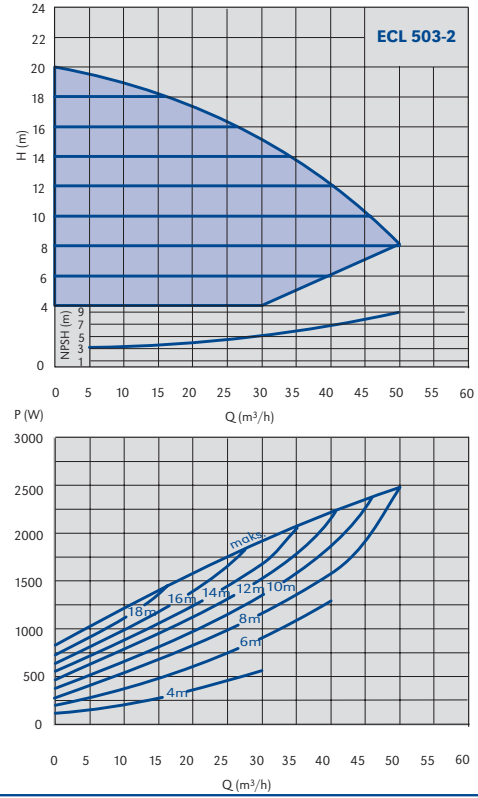
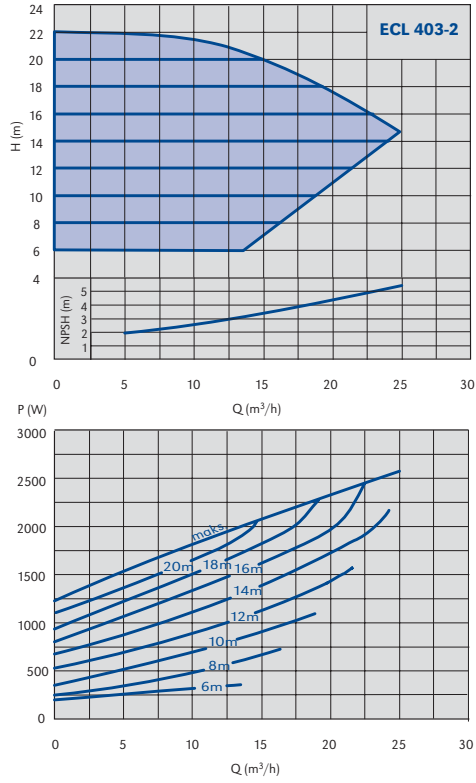

TEHNIICAL DATA / TECHNISCHE DATEN

pump type pumpentyp	code artikelnummer	connection size rohranschluss DN (")	connection type rohranschluss	max. flow durchfluss Q (m ³ /h)	max. pressure druck H (m)	system pressure systemdruck PN (bar)	min. media temp. des medius T min. °C	max. media temp. des medius T max. °C	casing type werkstoffe GG / Cast iron	single-S, double-D, einzelne-E, zwillings- bauform-Z	weight gewicht (kg)	regulation geregelt yes /ja no /nein	degree of protection schutzart IP
ECL 401 - 4	979520416	DN 40	flanges/flansche	25	15	PN 16	-15	140	GG/CI	S/E	50	yes/ja	54
ECL 402 - 4	979520417	DN 40	flanges/flansche	18	8	PN 16	-15	140	GG/CI	S/E	45	yes/ja	54
ECL 501 - 4	979520690	DN 50	flanges/flansche	36	15	PN 16	-15	140	GG/CI	S/E	52	yes/ja	54
ECL 502 - 4	979520420	DN 50	flanges/flansche	29	8	PN 16	-15	140	GG/CI	S/E	49	yes/ja	54
ECL 651 - 4	979520422	DN 65	flanges/flansche	56	15	PN 16	-15	140	GG/CI	S/E	65	yes/ja	54
ECL 652 - 4	979520423	DN 65	flanges/flansche	54	8	PN 16	-15	140	GG/CI	S/E	53	yes/ja	54
ECL 801 - 4	979520425	DN 80	flanges/flansche	85	15	PN 16	-15	140	GG/CI	S/E	80	yes/ja	54
ECL 802 - 4	979520426	DN 80	flanges/flansche	85	9	PN 16	-15	140	GG/CI	S/E	72	yes/ja	54
ECL 1001 - 4	979520579	DN 100	flanges/flansche	140	15	PN 16	-15	140	GG/CI	S/E	88	yes/ja	54
ECL 1002 - 4	979520580	DN 100	flanges/flansche	140	9,5	PN 16	-15	140	GG/CI	S/E	87	yes/ja	54
ECL 403 - 2	979520445	DN 40	flanges/flansche	32	26	PN 16	-15	140	GG/CI	S/E	45	yes/ja	54
ECL 503 - 2	979520444	DN 50	flanges/flansche	43	21	PN 16	-15	140	GG/CI	S/E	73	yes/ja	54
ECL 653 - 2	979520443	DN 65	flanges/flansche	72	26	PN 16	-15	140	GG/CI	S/E	83	yes/ja	54
ECL 803 - 2	979520442	DN 80	flanges/flansche	135	22	PN 16	-15	140	GG/CI	S/E	113	yes/ja	54

DIMENSIONS / MAÖE

pump type pumpentyp	code artikelnummer	length einbaulänge L (mm)	DN	a	f	l1	l	h1	h2	D1	D2	D3	no. hole
ECL 401 - 4	979520416	390	40	90	155	234	479	180	180	150	110	18	4
ECL 402 - 4	979520417	360	40	90	155	234	479	180	180	150	110	18	4
ECL 501 - 4	979520690	425	50	96	159	249	504	180	200	165	125	18	4
ECL 502 - 4	979520420	380	50	96	159	249	504	180	200	165	125	18	4
ECL 651 - 4	979520422	480	65	95	164	249	508	200	220	185	145	18	4
ECL 652 - 4	979520423	420	65	95	164	249	508	200	220	185	145	18	4
ECL 801 - 4	979520425	530	80	103	168	307	578	220	260	200	160	18	8
ECL 802 - 4	979520426	480	80	103	168	307	578	220	260	200	160	18	8
ECL 1001 - 4	979520579	560	100	113	169	307	589	245	275	220	180	18	8
ECL 1002 - 4	979520580	520	100	113	169	307	589	245	275	220	180	18	8
ECL 403 - 2	979520445	340	40	90	155	314	559	160	180	150	110	18	4
ECL 503 - 2	979520444	340	50	96	159	314	569	160	180	165	125	18	4
ECL 653 - 2	979520443	390	65	95	189	361	645	180	210	185	145	18	4
ECL 803 - 2	979520442	440	80	103	193	357	653	200	240	200	160	18	8

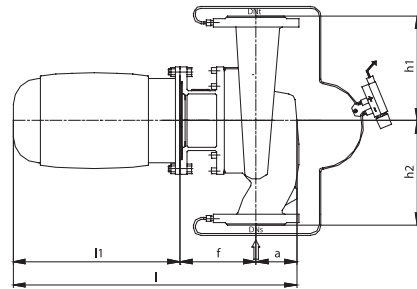
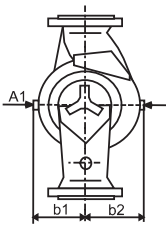
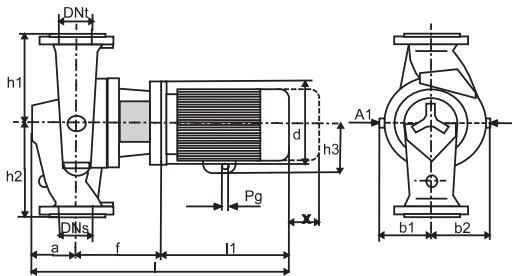

ELECTRICAL DATA / ELEKTRISCHE DATEN

pump type pumpentyp	code artikelnummer	power max. leistungsaufnahme P (W)	speed range drehzahlstufe (min-1)	FLC I nennstrom In (A)	electrical voltage elektroanschluss I (V)	insulating class isoliationsklasse
ECL 401 - 4	979520416	1100	650 - 1400	2,9	3 x 400 V	E
ECL 402 - 4	979520417	750	650 - 1400	2,07	3 x 400 V	E
ECL 501 - 4	979520690	1500	650 - 1400	3,8	3 x 400 V	E
ECL 502 - 4	979520420	1100	650 - 1400	2,9	3 x 400 V	E
ECL 651 - 4	979520422	2200	650 - 1400	5,2	3 x 400 V	E
ECL 652 - 4	979520423	1100	650 - 1400	2,9	3 x 400 V	E
ECL 801 - 4	979520425	3000	650 - 1400	7,2	3 x 400 V	E
ECL 802 - 4	979520426	2200	650 - 1400	5,2	3 x 400 V	E
ECL 1001 - 4	979520579	4000	650 - 1400	9,1	3 x 400 V	E
ECL 1002 - 4	979520580	3000	650 - 1400	7,2	3 x 400 V	E
ECL 403 - 2	979520445	3000	1400 - 2850	7,2	3 x 400 V	E
ECL 503 - 2	979520444	3000	1400 - 2850	7,2	3 x 400 V	E
ECL 653 - 2	979520443	5500	1400 - 2850	11,1	3 x 400 V	E
ECL 803 - 2	979520442	7500	1400 - 2850	14,7	3 x 400 V	E

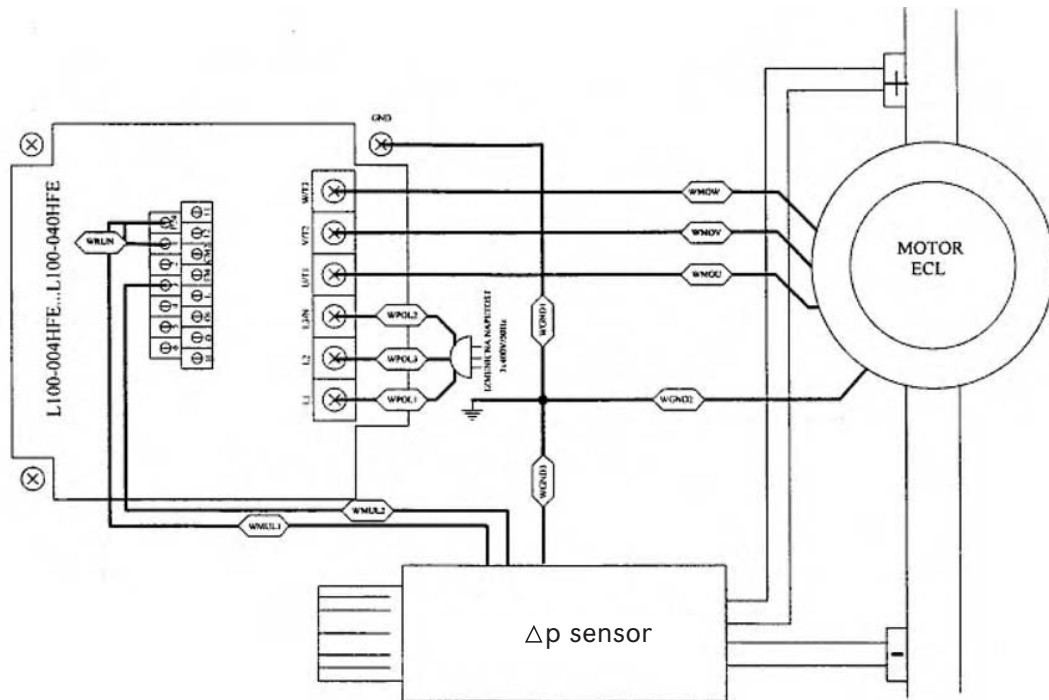



IMPPUMPS

THE HONEST PRODUCT FOR THE HONEST PRICE

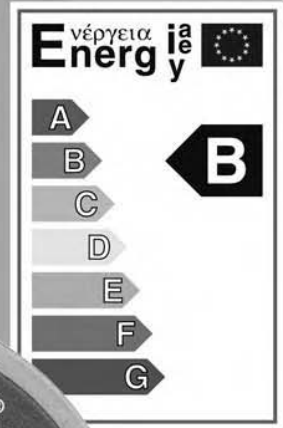

CIRCULATING
PUMP

UMWÄLZPUMPE

CV / CL / CLD

CV / CL / CLD



In-line pumps /
Trockenläuferpumpen



Certified ISO 9001 - 2000 by

In-line pumps Trockenläuferpumpen

TEHNIICAL FEATURES / TECHNISCHE MERKMALE		CV	CL	CLD
Connections / Nennweite	DN (")	32	32 do 150	40 do 100
Connection type / Rohranschluss		Flanges / Flansche	Flanges / Flansche	Flanges / Flansche
Flow max / Förderstrom max	Q (m ³ /h)	14	160	280
Pressure max / Förderhöhe	H (m)	6	60	60
Pressure rated / Betriebsdruck	PN (bar)	10 / 16	16	16
Power max / Leistungsaufnahme max	P (W)	250	37000	22000
Electrical voltage / Elektroanschluss	V	3 x 400 AC	3 x 400 AC	3 x 400 AC
Degree of protection / Schutzart	IP	54	55	55
Regulation / Regelung		no / nein	optional	optional
Media temperature / Temperaturbereich	T(°C)	-10 to/bis +110	-10 to/bis +130/140	-10 to/bis +130/140
Insulating class / Isolationsklasse		E	E, F	F
Casing type / Werkstoffe		GG / Cast iron	GG / Cast iron	GG / Cast iron
Duble pump / Zwillingspumpe		no / nein	no / nein	yes /ja
APPLICATIONS / EINSATZGEBIETE				
Heating / Warmwasserheizungen		✓	✓	✓
Cooling / Kaltwasseranlagen		✓	✓	✓
Sanitary water / Brauchwasser		✓	✓	
Climate appliances / Klimaanlage		✓	✓	✓
Industry / Industrieanlagen		✓	✓	✓
Process technique / Verfahrenstechnik		✓	✓	✓
Condensation / Kondensat				✓
Salt water / Meerwasser				

Pump markings / Typenschlüssel

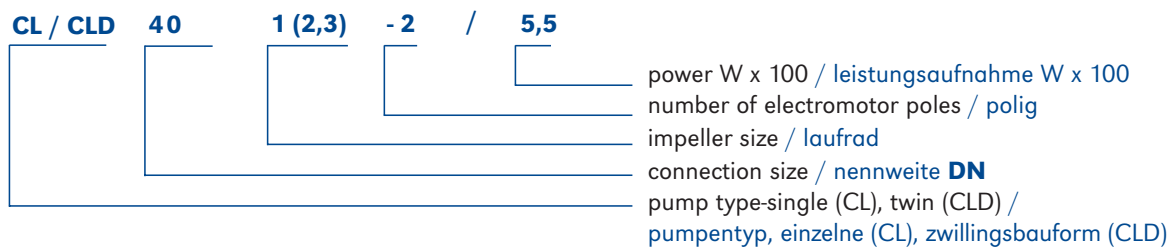
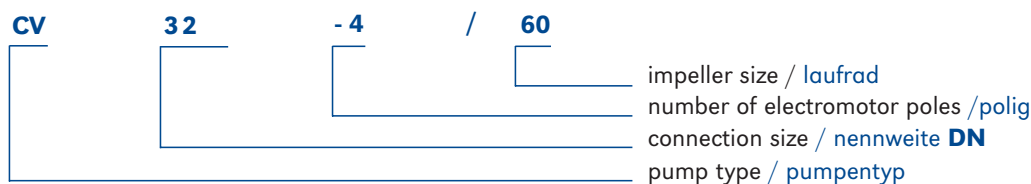

Permitted mounting positions / Einbaumöglichkeiten

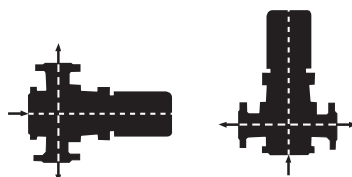

Standard in-line pumps Standard - Inline Pumpen

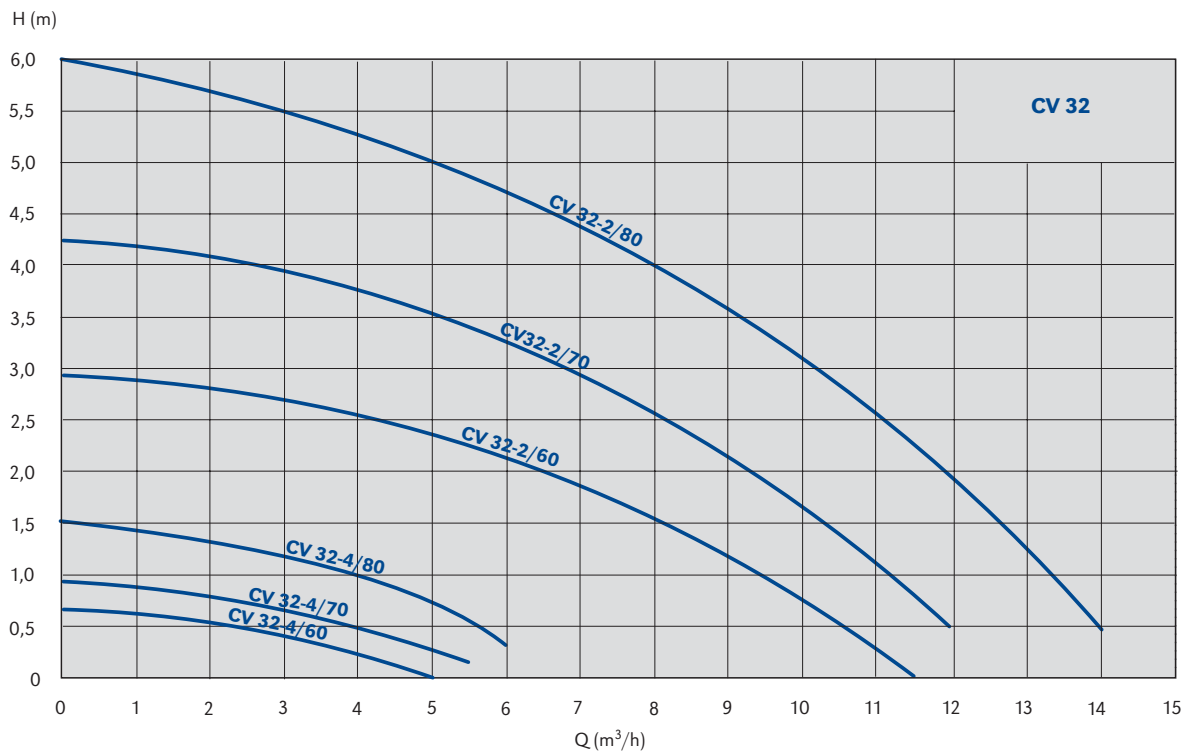
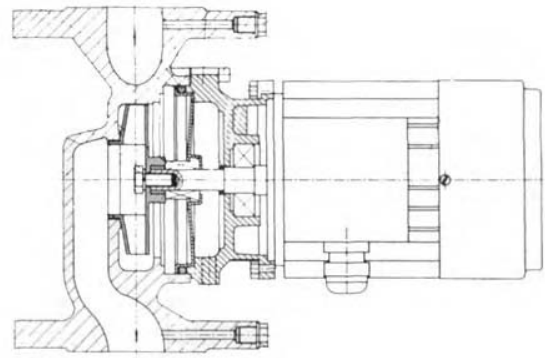
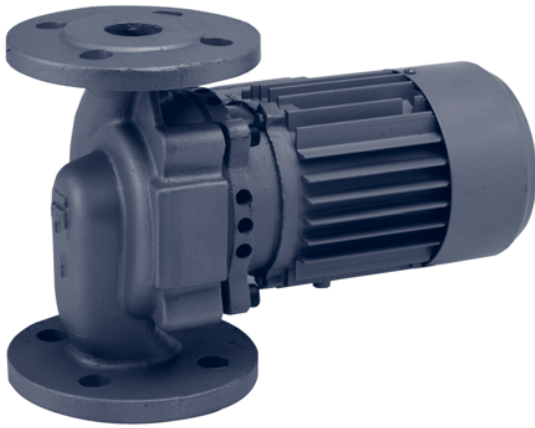

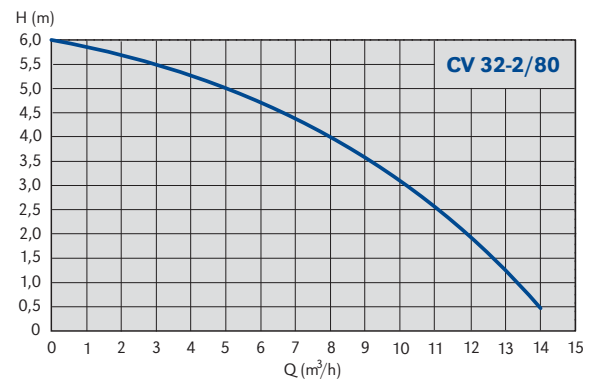
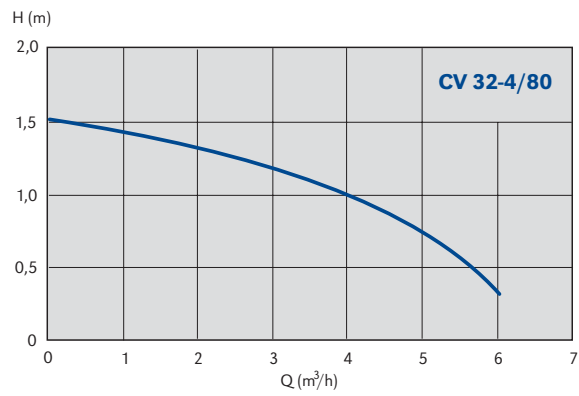
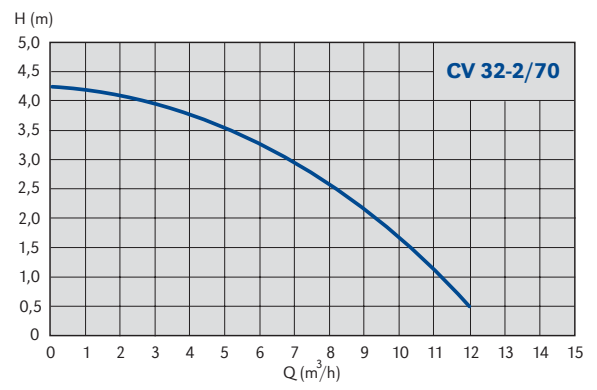
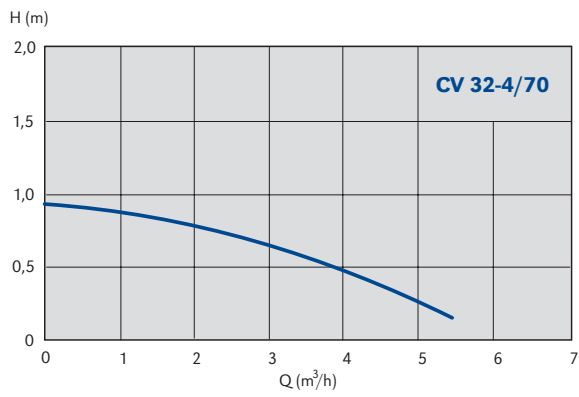
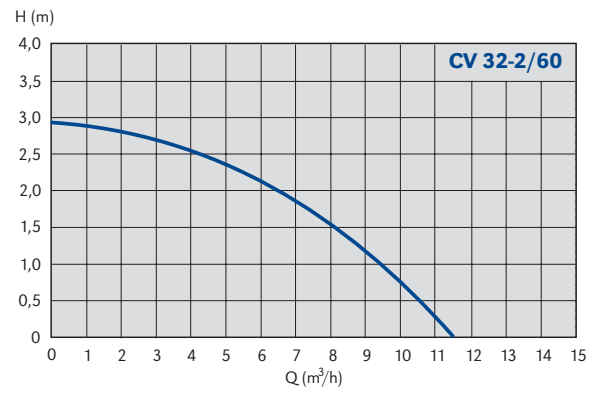
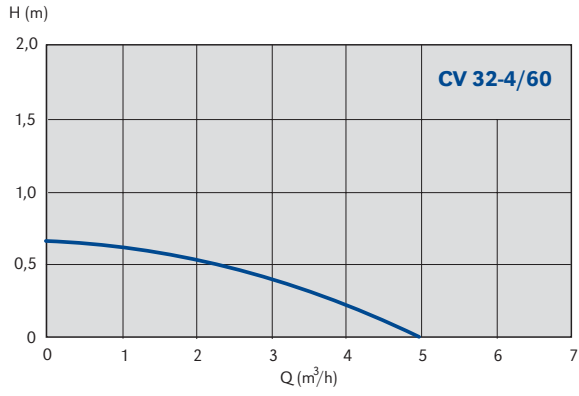

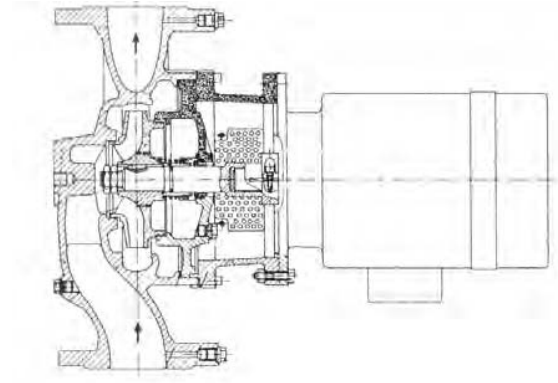

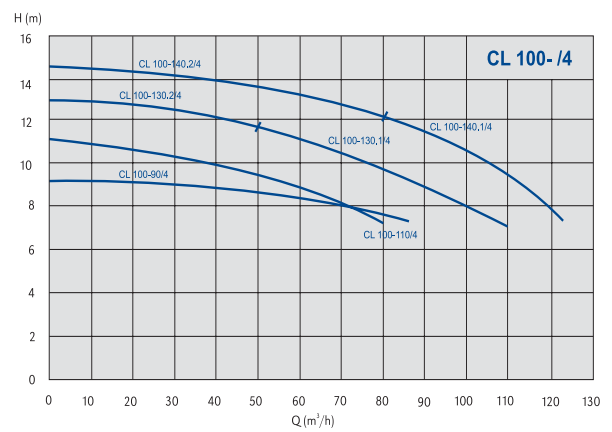
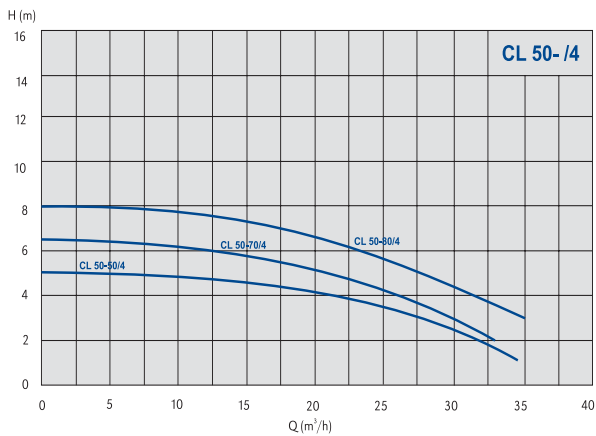
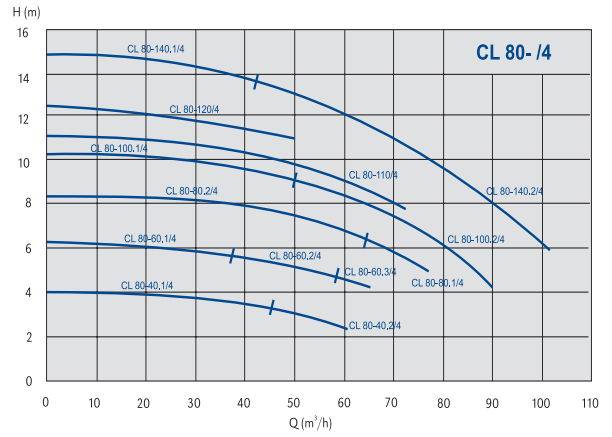
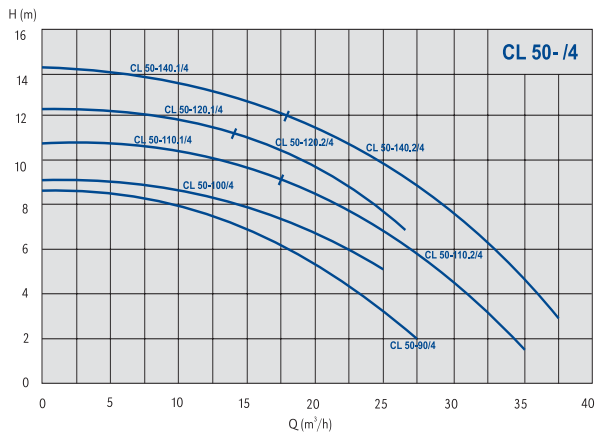
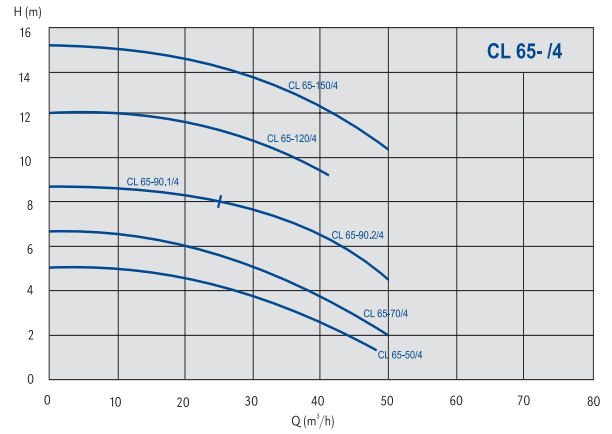
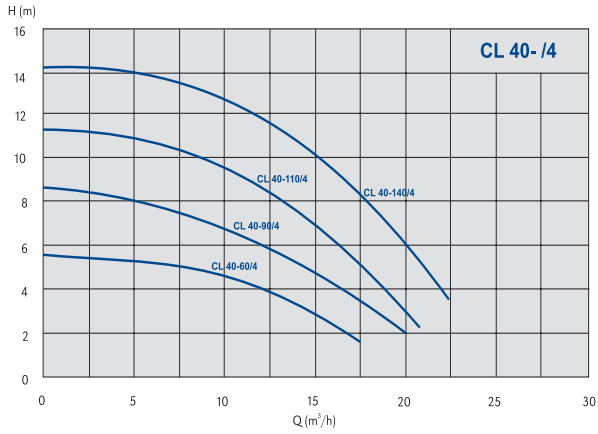

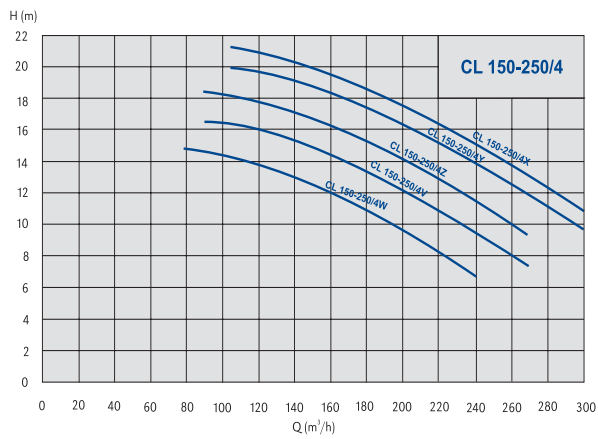
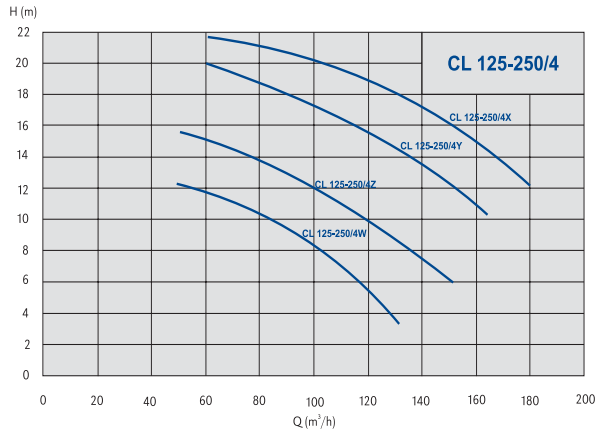

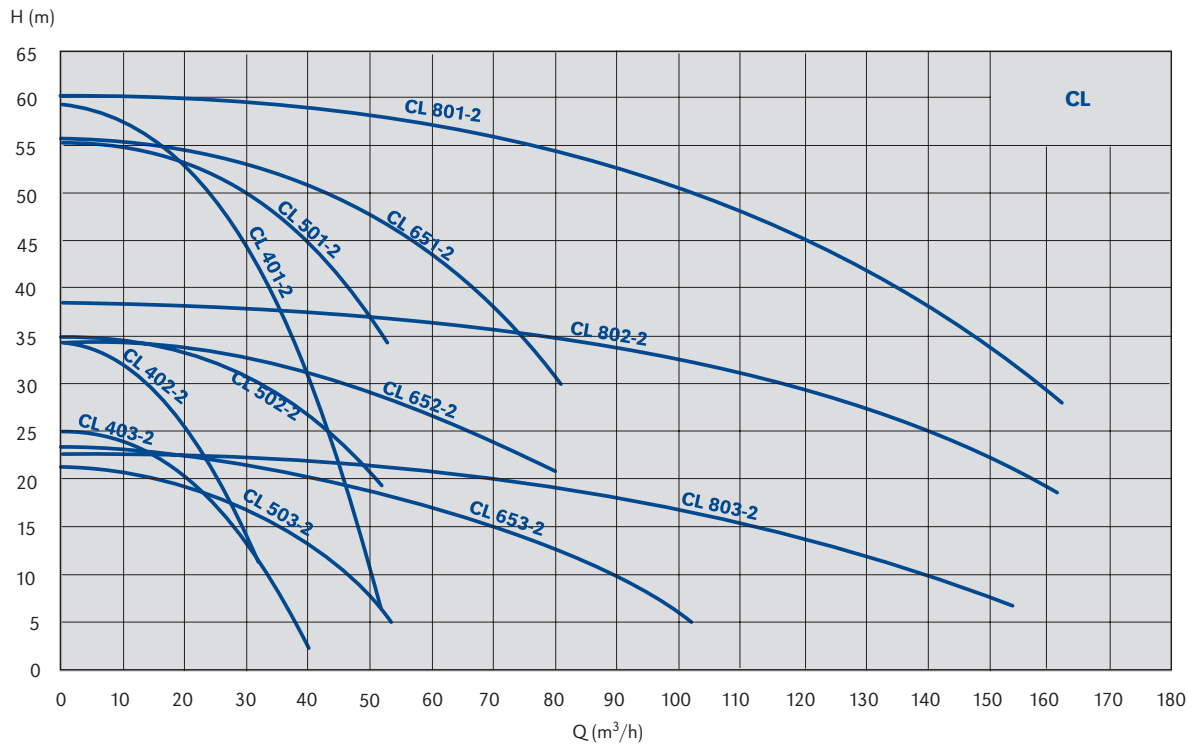
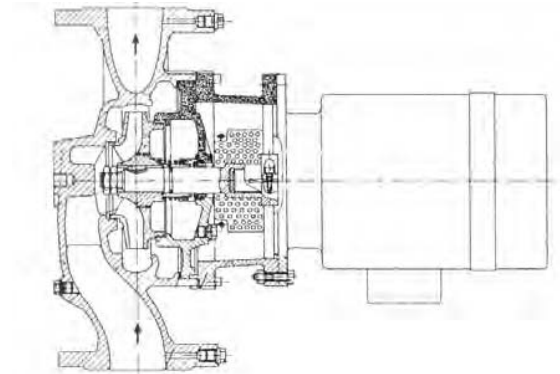
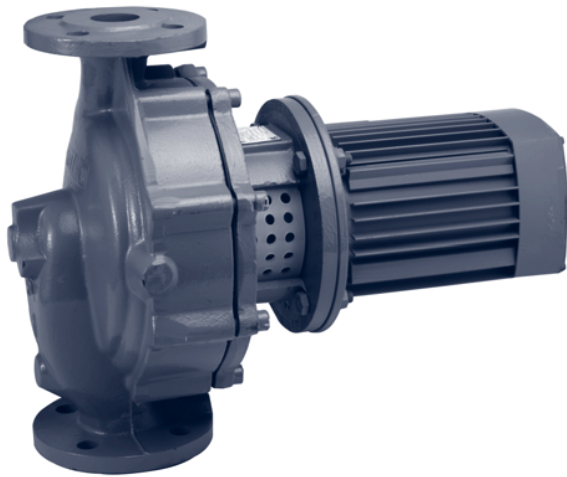

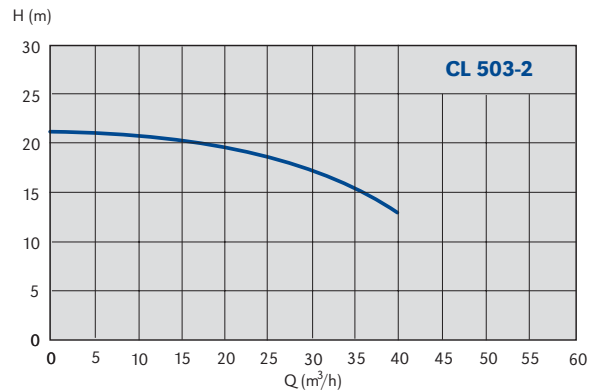
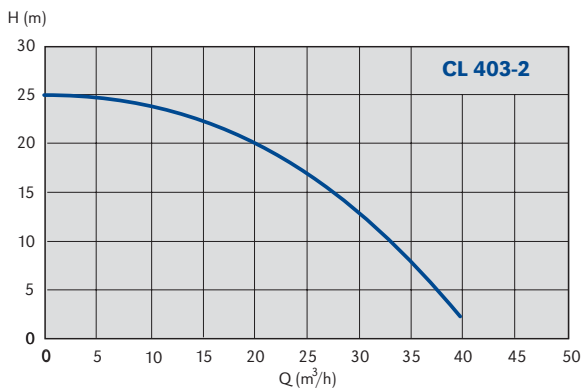
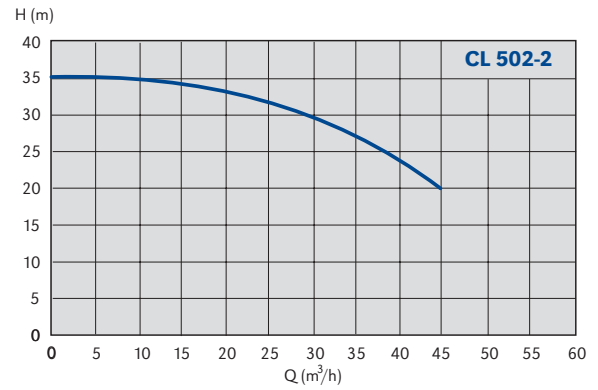
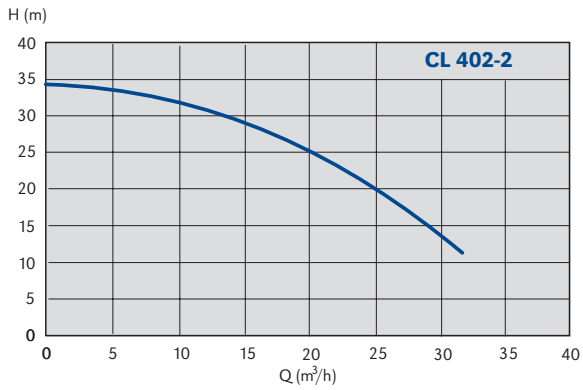
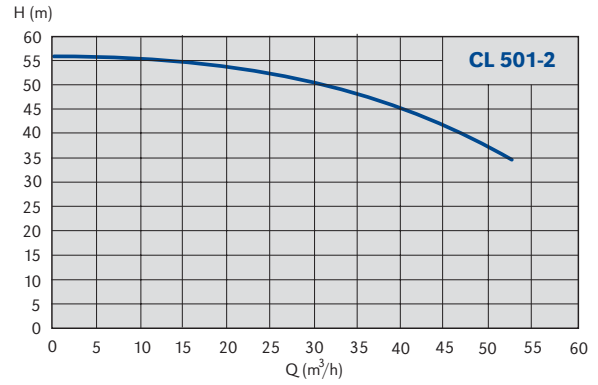
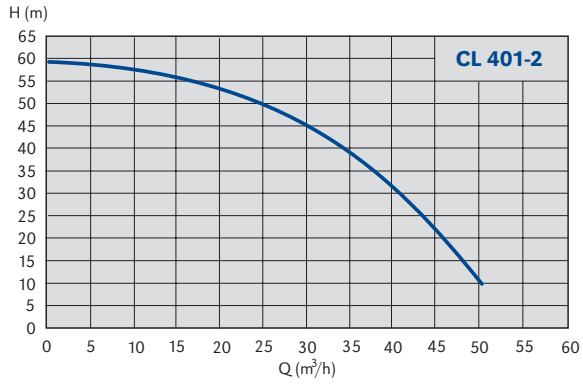

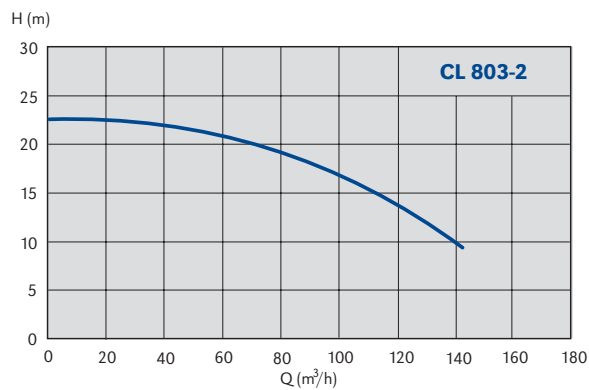
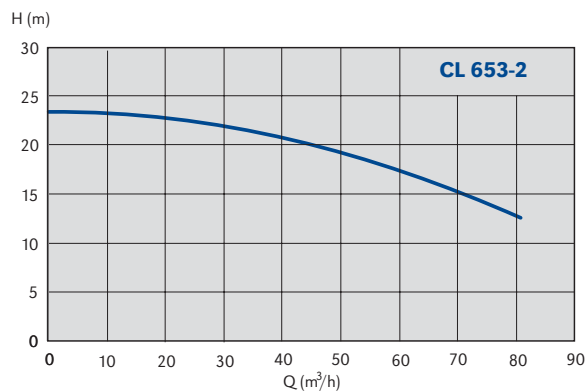
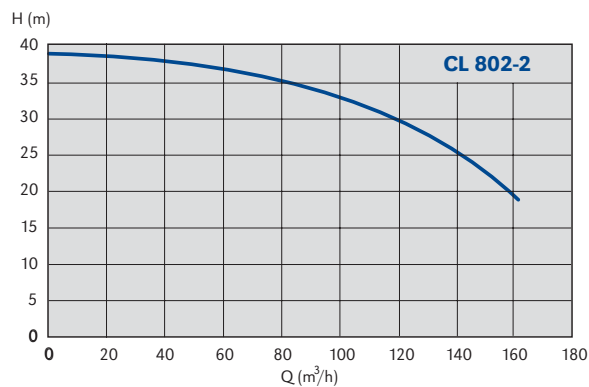
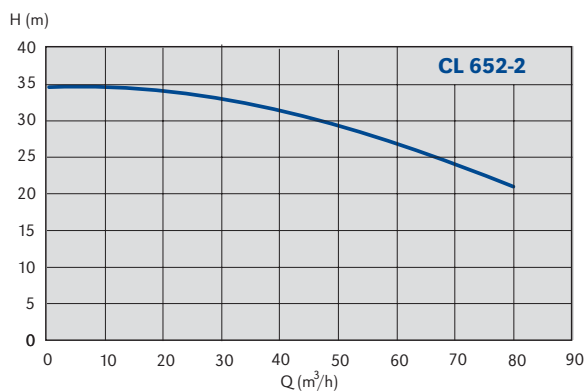
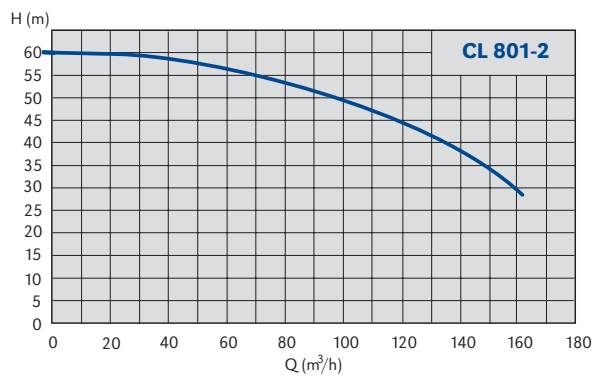
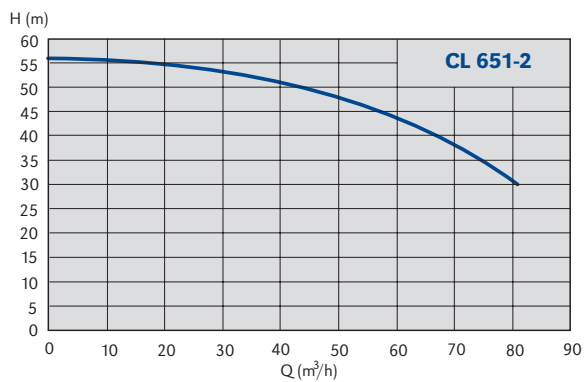

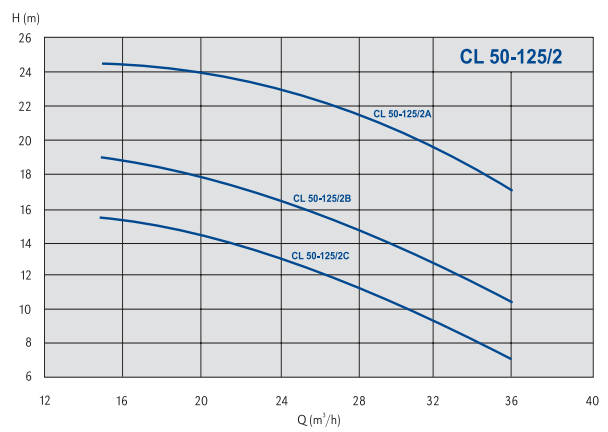
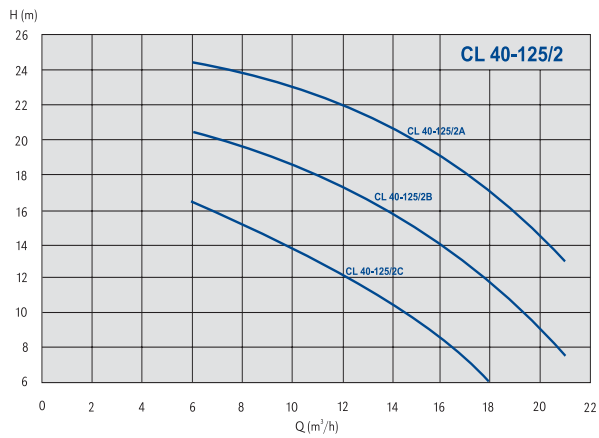
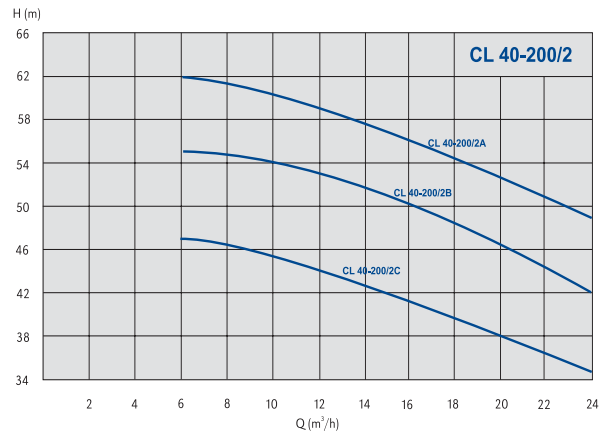
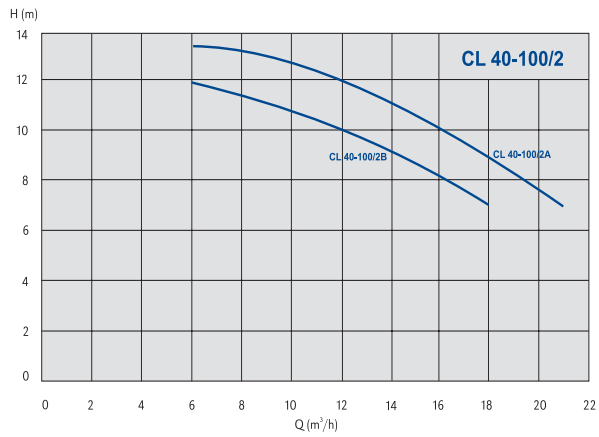
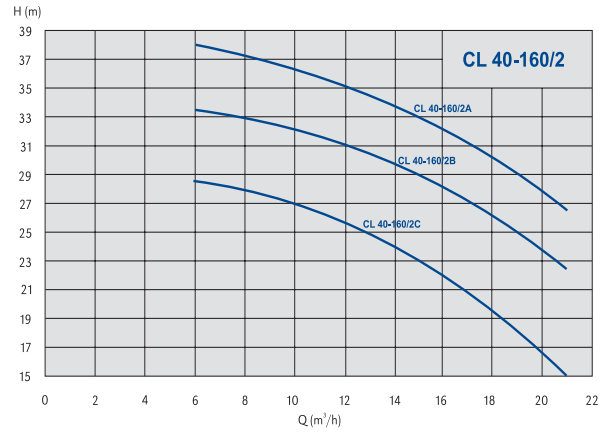
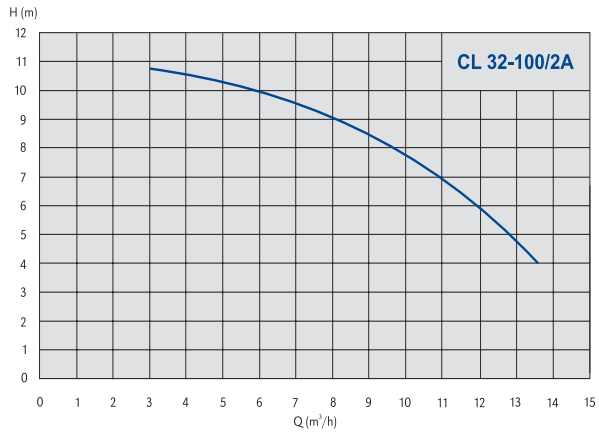

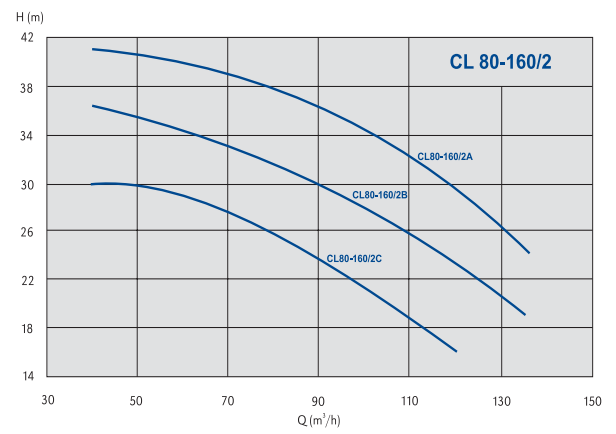
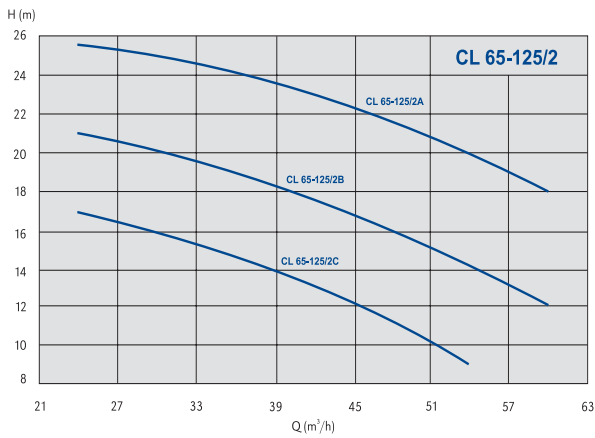
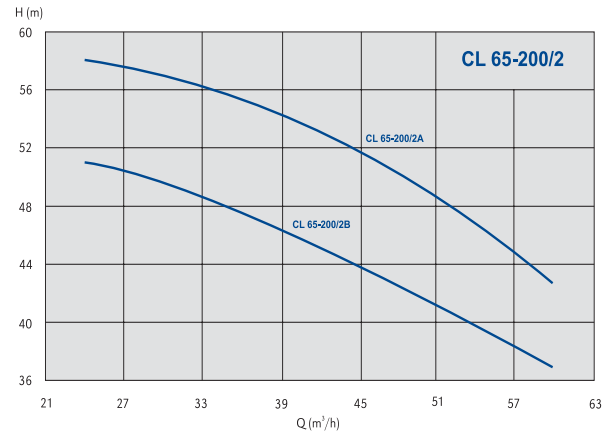
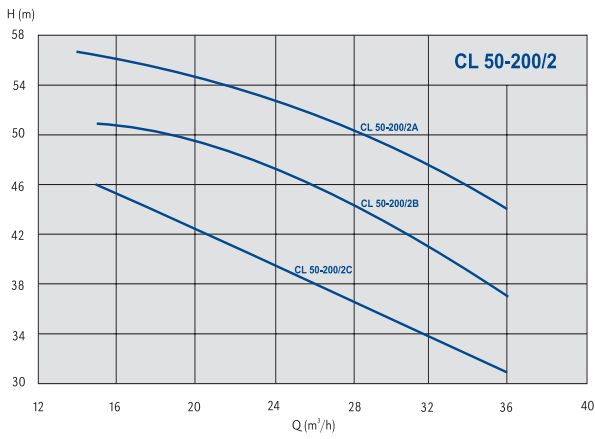
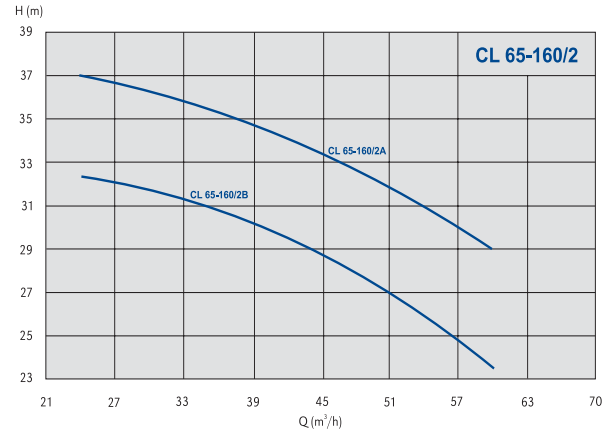
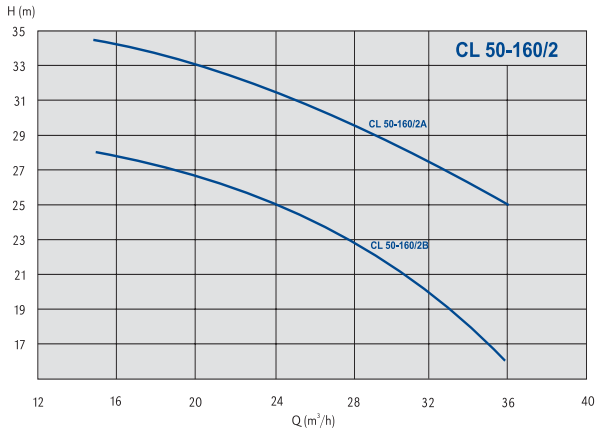

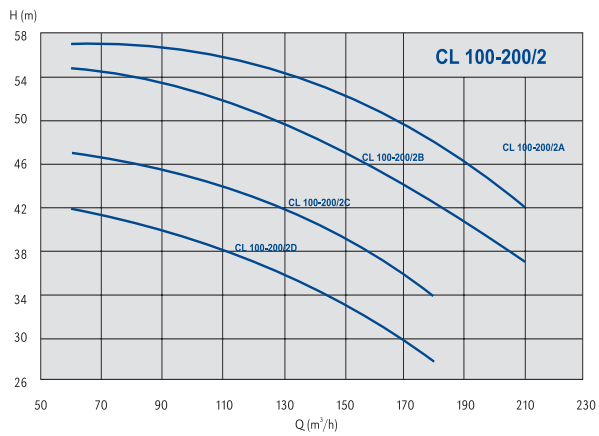
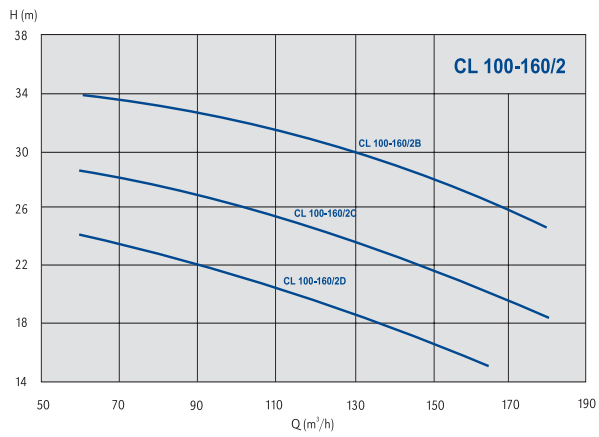
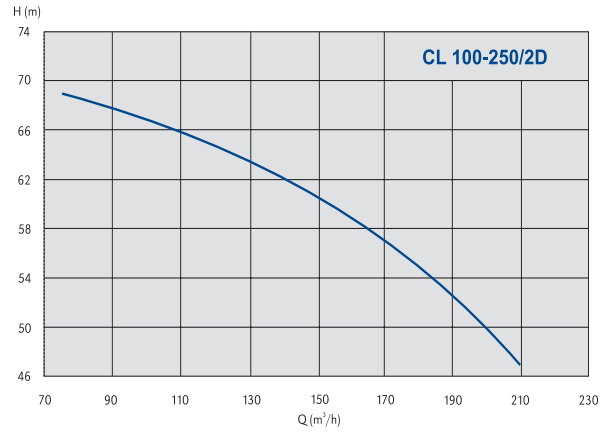
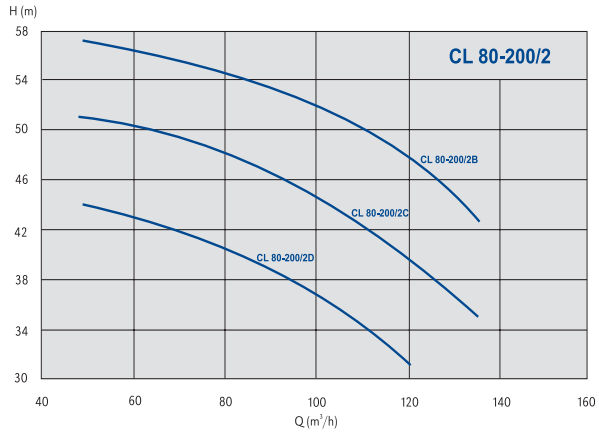

Standard double in-line pumps
Standard - Inline Pumpen - Doppelauslegung

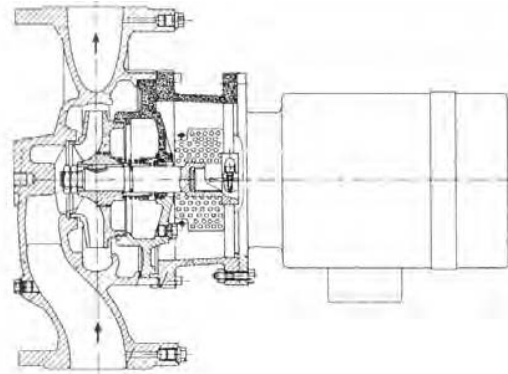
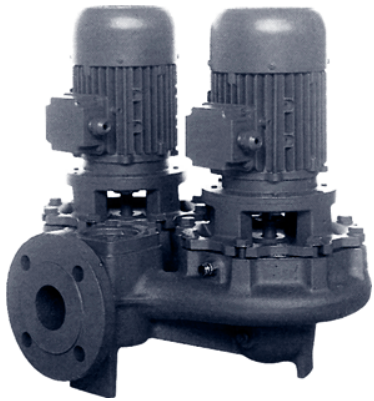

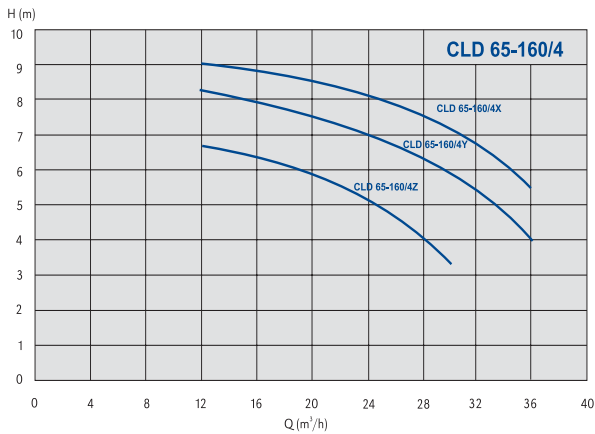
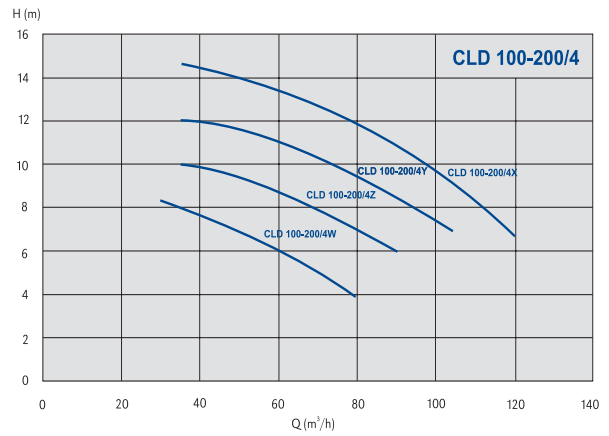
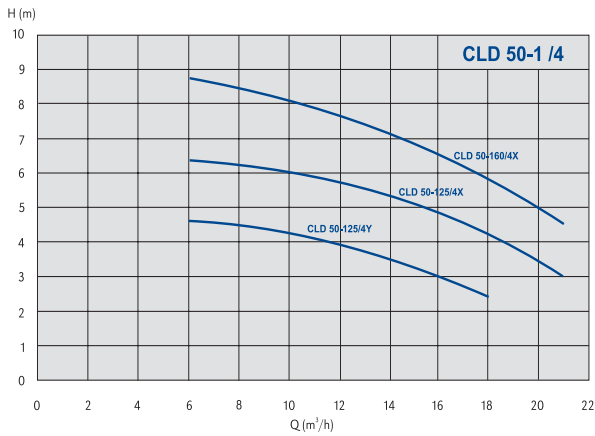
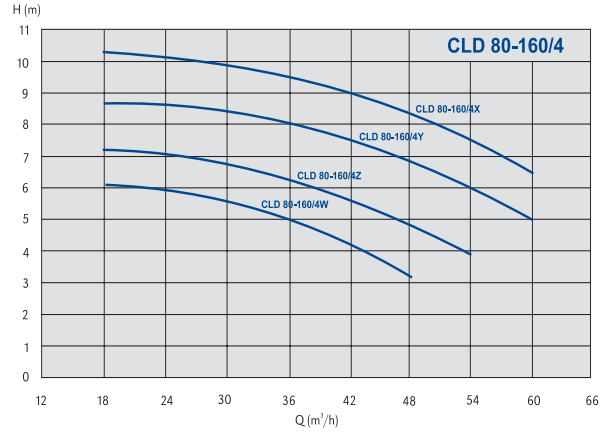
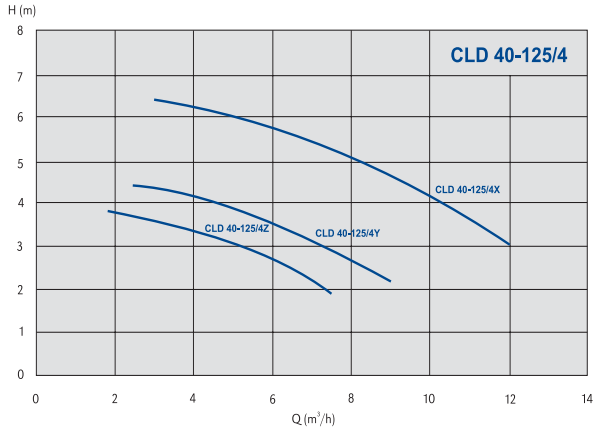

Standard double in-line pumps
Standard - Inline Pumpen - Doppelauslegung

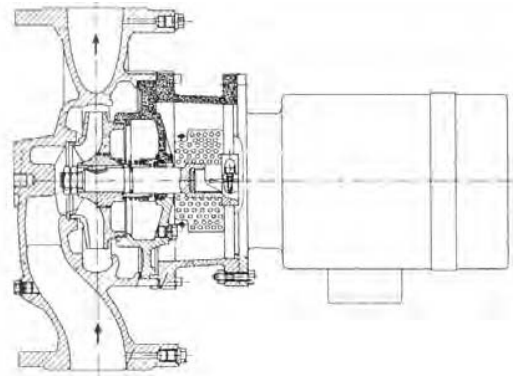
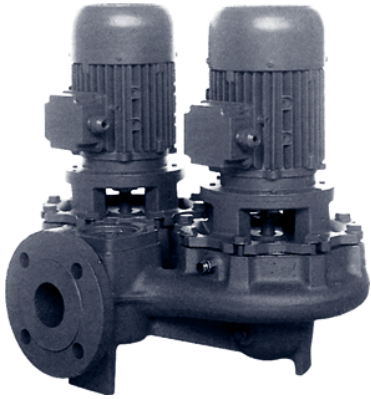

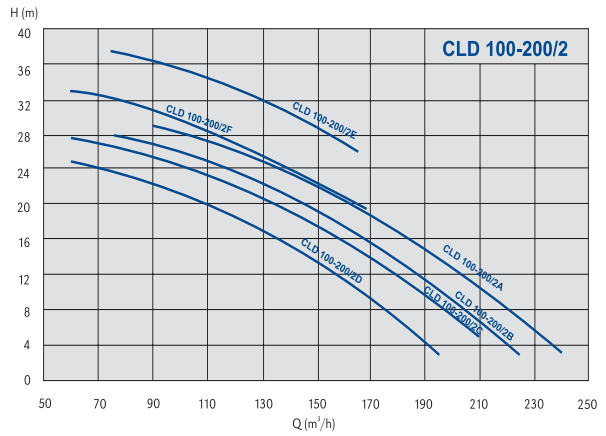
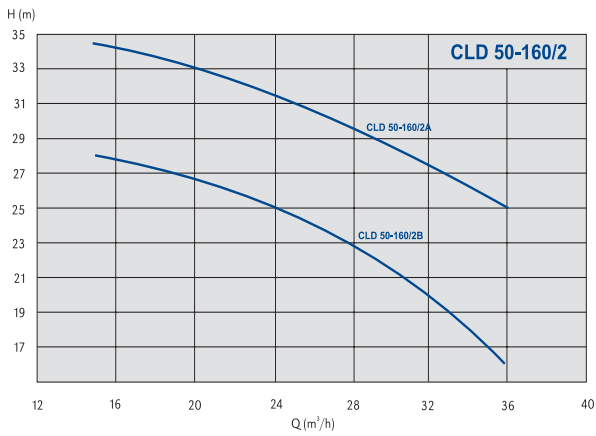
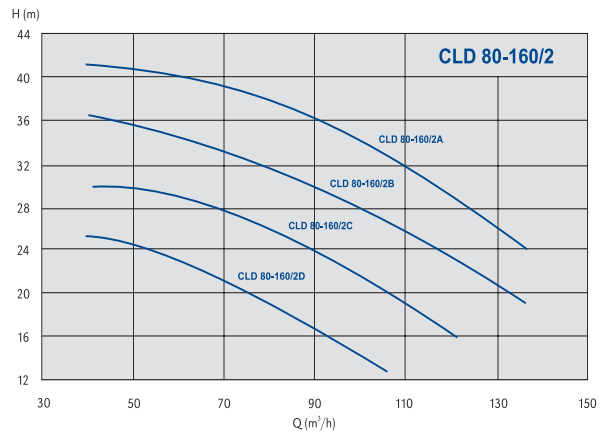
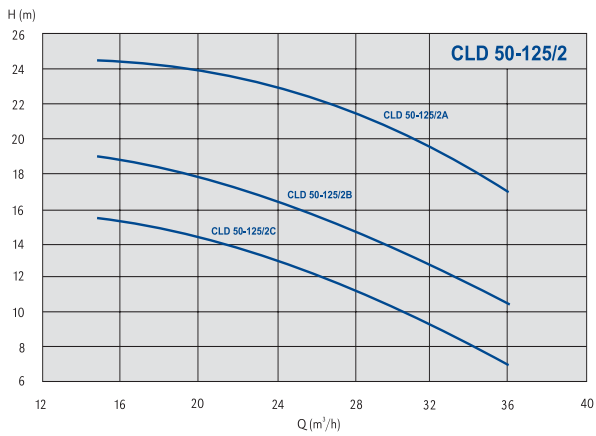
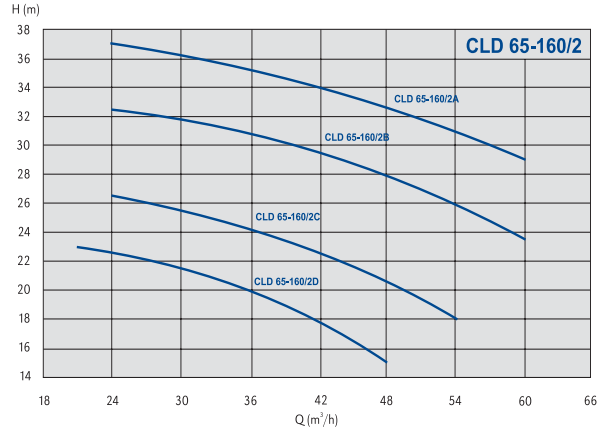
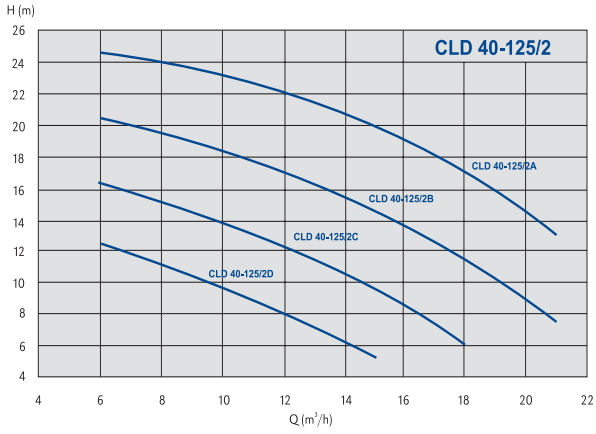

TEHNICAL DATA / TECHNISCHE DATEN

pump type pumpentyp	code artikelnummer	connection size rohranschluss DN (")	connection type rohranschluss	max. flow durchfluss Q (m ³ /h)	max. pressure druck H (m)	system pressure systemdruck PN (bar)	min. media temp. des mediums T min. °C	max. media temp. des mediums T max. °C	casing type werkstoffe GG / Cast iron	single-S, double-D einzelne-E, zwillings- bauform-Z	weight gewicht (kg)	regulation geregelt yes / ja no / nein	degree of protection schutzart IP
CV 32 - 4 / 60	979521359	DN 32	flanges/flansche	4	0,6	PN 16	-10	110	GG/CI	S/E	15	no/nein	54
CV 32 - 4 / 70	979521358	DN 32	flanges/flansche	5	0,9	PN 16	-10	110	GG/CI	S/E	15	no/nein	54
CV 32 - 4 / 80	979521357	DN 32	flanges/flansche	7	1,5	PN 16	-10	110	GG/CI	S/E	15	no/nein	54
CV 32 - 2 / 60	979521356	DN 32	flanges/flansche	8	3	PN 16	-10	110	GG/CI	S/E	15	no/nein	54
CV 32 - 2 / 70	979521355	DN 32	flanges/flansche	9,5	4	PN 16	-10	110	GG/CI	S/E	15	no/nein	54
CV 32 - 2 / 80	979521354	DN 32	flanges/flansche	13	6	PN 16	-10	110	GG/CI	S/E	15	no/nein	54

TEHNIICAL DATA / TECHNISCHE DATEN

pump type pumpentyp	code artikelnummer	connection size rohranschluss DN (")	connection type rohranschluss	max. flow durchfluss Q (m ³ /h)	max. pressure druck H (m)	system pressure systemdruck PN (bar)	min. media temp. des mediums T min.°C	max. media temp. des mediums T max.°C	casing type werkstoffe GG / Cast iron	single-S, double-D einzelne-E, zwillings- bauform-Z	weight gewicht (kg)	regulation geregelt yes /ja no /nein	degree of protection schutzart IP
CL 40-140/4	979520741	DN 40	flanges/flansche	22	14	PN 16	-10	140	GG/CI	S/E	45	optional	55
CL 40-110/4	979521582	DN 40	flanges/flansche	21	11	PN 16	-10	140	GG/CI	S/E	41	optional	55
CL 40-90/4	979522606	DN 40	flanges/flansche	20	9	PN 16	-10	140	GG/CI	S/E	39	optional	55
CL 40-60/4	979520743	DN 40	flanges/flansche	18	6	PN 16	-10	140	GG/CI	S/E	22	optional	55
CL 50-140.1/4	979521584	DN 50	flanges/flansche	18	14	PN 16	-10	140	GG/CI	S/E	44	optional	55
CL 50-140.2/4	979520744	DN 50	flanges/flansche	33	14	PN 16	-10	140	GG/CI	S/E	47	optional	55
CL 50-120.1/4	979521586	DN 50	flanges/flansche	14	12	PN 16	-10	140	GG/CI	S/E	40	optional	55
CL 50-120.2/4	979521585	DN 50	flanges/flansche	21	12	PN 16	-10	140	GG/CI	S/E	44	optional	55
CL 50-110.1/4	979521588	DN 50	flanges/flansche	17	11	PN 16	-10	140	GG/CI	S/E	40	optional	55
CL 50-110.2/4	979521587	DN 50	flanges/flansche	34	11	PN 16	-10	140	GG/CI	S/E	44	optional	55
CL 50-100/4	979521589	DN 50	flanges/flansche	23	10	PN 16	-10	140	GG/CI	S/E	40	optional	55
CL 50-90/4	979521590	DN 50	flanges/flansche	28	9	PN 16	-10	140	GG/CI	S/E	39	optional	55
CL 50-80/4	979520745	DN 50	flanges/flansche	35	8	PN 16	-10	140	GG/CI	S/E	44	optional	55
CL 50-70/4	979521591	DN 50	flanges/flansche	31	7	PN 16	-10	140	GG/CI	S/E	39	optional	55
CL 50-50/4	979520746	DN 50	flanges/flansche	30	5	PN 16	-10	140	GG/CI	S/E	42	optional	55
CL 65-150/4	979520747	DN 65	flanges/flansche	51	15	PN 16	-10	140	GG/CI	S/E	60	optional	55
CL 65-120/4	979522773	DN 65	flanges/flansche	38	12	PN 16	-10	140	GG/CI	S/E	55	optional	55
CL 65-90.1/4	979522772	DN 65	flanges/flansche	24	9	PN 16	-10	140	GG/CI	S/E	44	optional	55
CL 65-90.2/4	979520748	DN 65	flanges/flansche	49	9	PN 16	-10	140	GG/CI	S/E	48	optional	55
CL 65-70/4	979521617	DN 65	flanges/flansche	46	7	PN 16	-10	140	GG/CI	S/E	44	optional	55
CL 65-50/4	979522771	DN 65	flanges/flansche	45	5	PN 16	-10	140	GG/CI	S/E	39	optional	55
CL 80-140.1/4	979521594	DN 80	flanges/flansche	40	14	PN 16	-10	140	GG/CI	S/E	72	optional	55
CL 80-140.2/4	979520750	DN 80	flanges/flansche	91	14	PN 16	-10	140	GG/CI	S/E	74	optional	55
CL 80-120/4	979522770	DN 80	flanges/flansche	51	12	PN 16	-10	140	GG/CI	S/E	72	optional	55
CL 80-110/4	979521595	DN 80	flanges/flansche	70	11	PN 16	-10	140	GG/CI	S/E	72	optional	55
CL 80-100.1/4	979522768	DN 80	flanges/flansche	48	10	PN 16	-10	140	GG/CI	S/E	67	optional	55
CL 80-100.2/4	979522769	DN 80	flanges/flansche	87	10	PN 16	-10	140	GG/CI	S/E	72	optional	55
CL 80-80.1/4	979522766	DN 80	flanges/flansche	64	8	PN 16	-10	140	GG/CI	S/E	61	optional	55
CL 80-80.2/4	979522767	DN 80	flanges/flansche	106	8	PN 16	-10	140	GG/CI	S/E	66	optional	55
CL 80-60.1/4	979521596	DN 80	flanges/flansche	32	6	PN 16	-10	140	GG/CI	S/E	47	optional	55
CL 80-60.2/4	979520752	DN 80	flanges/flansche	59	6	PN 16	-10	140	GG/CI	S/E	51	optional	55
CL 80-40.1/4	979521599	DN 80	flanges/flansche	48	4	PN 16	-10	140	GG/CI	S/E	46	optional	55
CL 80-40.2/4	979522764	DN 80	flanges/flansche	78	4	PN 16	-10	140	GG/CI	S/E	47	optional	55
CL 100-140.1/4	979521600	DN 100	flanges/flansche	74	14	PN 16	-10	140	GG/CI	S/E	74	optional	55
CL 100-140.2/4	979520753	DN 100	flanges/flansche	119	14	PN 16	-10	140	GG/CI	S/E	80	optional	55
CL 100-130.1/4	979521602	DN 100	flanges/flansche	50	13	PN 16	-10	140	GG/CI	S/E	72	optional	55
CL 100-130.2/4	979521601	DN 100	flanges/flansche	110	13	PN 16	-10	140	GG/CI	S/E	74	optional	55
CL 100-110/4	979521603	DN 100	flanges/flansche	81	11	PN 16	-10	140	GG/CI	S/E	72	optional	55
CL 100-90/4	979520754	DN 100	flanges/flansche	86	9,2	PN 16	-10	140	GG/CI	S/E	79	optional	55
CL 125-250/4W		DN 125	flanges/flansche	130	13	PN 16	-10	130	GG/CI	S/E	132	optional	55
CL 125-250/4Z		DN 125	flanges/flansche	150	16	PN 16	-10	130	GG/CI	S/E	132	optional	55
CL 125-250/4Y		DN 125	flanges/flansche	170	21	PN 16	-10	130	GG/CI	S/E	135	optional	55
CL 125-250/4X		DN 125	flanges/flansche	180	22	PN 16	-10	130	GG/CI	S/E	136	optional	55
CL 150-250/4W		DN 150	flanges/flansche	250	15	PN 16	-10	130	GG/CI	S/E	154	optional	55
CL 150-250/4V		DN 150	flanges/flansche	270	16,5	PN 16	-10	130	GG/CI	S/E	158	optional	55
CL 150-250/4Z		DN 150	flanges/flansche	280	18,5	PN 16	-10	130	GG/CI	S/E	162	optional	55
CL 150-250/4Y		DN 150	flanges/flansche	300	20	PN 16	-10	130	GG/CI	S/E	201	optional	55
CL 150-250/4X		DN 150	flanges/flansche	310	21,5	PN 16	-10	130	GG/CI	S/E	201	optional	55

TEHNIICAL DATA / TECHNISCHE DATEN

pump type pumpentyp	code artikelnummer	connection size rohranschluss DN (")	connection type rohranschluss	max. flow durchfluss Q (m ³ /h)	max. pressure druck H (m)	system pressure systemdruck PN (bar)	min. media temp. des mediums T min. °C	max. media temp. des mediums T max. °C	casing type werkstoffe GG / Cast iron	single-S, double-D einzelne-E, zwillings- bauform-Z	weight gewicht (kg)	regulation geregelt yes / ja no / nein	degree of protection schutzart IP
CL 401 - 2	979520867	DN 40	flanges/flansche	13	57	PN 16	-15	140	GG/CI	S/E	76	optional	54
CL 402 - 2	979520868	DN 40	flanges/flansche	32	32	PN 16	-15	140	GG/CI	S/E	70	optional	54
CL 403 - 2	979520869	DN 40	flanges/flansche	32	26	PN 16	-15	140	GG/CI	S/E	38	optional	54
CL 501 - 2	979520870	DN 50	flanges/flansche	54	57	PN 16	-15	140	GG/CI	S/E	130	optional	54
CL 502 - 2	979520871	DN 50	flanges/flansche	50	32	PN 16	-15	140	GG/CI	S/E	70	optional	54
CL 503 - 2	979520872	DN 50	flanges/flansche	43	21	PN 16	-15	140	GG/CI	S/E	66	optional	54
CL 651 - 2	979520873	DN 65	flanges/flansche	100	57	PN 16	-15	140	GG/CI	S/E	157	optional	54
CL 652 - 2	979520874	DN 65	flanges/flansche	72	32	PN 16	-15	140	GG/CI	S/E	99	optional	54
CL 653 - 2	979520875	DN 65	flanges/flansche	72	26	PN 16	-15	140	GG/CI	S/E	76	optional	54
CL 801 - 2	979520876	DN 80	flanges/flansche	160	57	PN 16	-15	140	GG/CI	S/E	210	optional	54
CL 802 - 2	979520877	DN 80	flanges/flansche	160	38	PN 16	-15	140	GG/CI	S/E	175	optional	54
CL 803 - 2	979520878	DN 80	flanges/flansche	135	22	PN 16	-15	140	GG/CI	S/E	103	optional	54
CL 32-100/2A		DN 32	flanges/flansche	14	11	PN 16	-10	130			12	optional	55
CL 40-100/2B		DN 40	flanges/flansche	18	12	PN 16	-10	130	GG/CI	S/E	16	optional	55
CL 40-100/2A		DN 40	flanges/flansche	21	13,5	PN 16	-10	130	GG/CI	S/E	16	optional	55
CL 40-125/2C		DN 40	flanges/flansche	18	17	PN 16	-10	130	GG/CI	S/E	24	optional	55
CL 40-125/2B		DN 40	flanges/flansche	21	21	PN 16	-10	130	GG/CI	S/E	25	optional	55
CL 40-125/2A		DN 40	flanges/flansche	23	24,5	PN 16	-10	130	GG/CI	S/E	26	optional	55
CL 40-160/2C		DN 40	flanges/flansche	21	28,5	PN 16	-10	130	GG/CI	S/E	30	optional	55
CL 40-160/2B		DN 40	flanges/flansche	22	33,5	PN 16	-10	130	GG/CI	S/E	35	optional	55
CL 40-160/2A		DN 40	flanges/flansche	23	38	PN 16	-10	130	GG/CI	S/E	37	optional	55
CL 40-200/2C		DN 40	flanges/flansche	24	47	PN 16	-10	130	GG/CI	S/E	50	optional	55
CL 40-200/2B		DN 40	flanges/flansche	28	55	PN 16	-10	130	GG/CI	S/E	50	optional	55
CL 40-200/2A		DN 40	flanges/flansche	32	62	PN 16	-10	130	GG/CI	S/E	50	optional	55
CL 50-125/2C		DN 50	flanges/flansche	36	15,5	PN 16	-10	130	GG/CI	S/E	27	optional	55
CL 50-125/2B		DN 50	flanges/flansche	39	19	PN 16	-10	130	GG/CI	S/E	28	optional	55
CL 50-125/2A		DN 50	flanges/flansche	42	24,5	PN 16	-10	130	GG/CI	S/E	32	optional	55
CL 50-160/2B		DN 50	flanges/flansche	35	28	PN 16	-10	130	GG/CI	S/E	32	optional	55
CL 50-160/2A		DN 50	flanges/flansche	42	35	PN 16	-10	130	GG/CI	S/E	42	optional	55
CL 50-200/2C		DN 50	flanges/flansche	36	46	PN 16	-10	130	GG/CI	S/E	56	optional	55
CL 50-200/2B		DN 50	flanges/flansche	40	51	PN 16	-10	130	GG/CI	S/E	57	optional	55
CL 50-200/2A		DN 50	flanges/flansche	42	57	PN 16	-10	130	GG/CI	S/E	64	optional	55
CL 65-125/2C		DN 65	flanges/flansche	52	17	PN 16	-10	130	GG/CI	S/E	35	optional	55
CL 65-125/2B		DN 65	flanges/flansche	60	21	PN 16	-10	130	GG/CI	S/E	39	optional	55
CL 65-125/2A		DN 65	flanges/flansche	68	25,5	PN 16	-10	130	GG/CI	S/E	43	optional	55
CL 65-160/2B		DN 65	flanges/flansche	58	32	PN 16	-10	130	GG/CI	S/E	54	optional	55
CL 65-160/2A		DN 65	flanges/flansche	70	37	PN 16	-10	130	GG/CI	S/E	61	optional	55
CL 65-200/2B		DN 65	flanges/flansche	58	51	PN 16	-10	130	GG/CI	S/E	70	optional	55
CL 65-200/2A		DN 65	flanges/flansche	63	58	PN 16	-10	130	GG/CI	S/E	77	optional	55
CL 80-160/2C		DN 80	flanges/flansche	120	30	PN 16	-10	130	GG/CI	S/E	72	optional	55
CL 80-160/2B		DN 80	flanges/flansche	140	37	PN 16	-10	130	GG/CI	S/E	79	optional	55
CL 80-160/2A		DN 80	flanges/flansche	150	41	PN 16	-10	130	GG/CI	S/E	85	optional	55
CL 80-200/2D		DN 80	flanges/flansche	120	44	PN 16	-10	130	GG/CI	S/E	91	optional	55
CL 80-200/2C		DN 80	flanges/flansche	140	51	PN 16	-10	130	GG/CI	S/E	124	optional	55
CL 80-200/2B		DN 80	flanges/flansche	150	57	PN 16	-10	130	GG/CI	S/E	142	optional	55
CL 100-160/2D		DN 100	flanges/flansche	160	24	PN 16	-10	130	GG/CI	S/E	76	optional	55
CL 100-160/2C		DN 100	flanges/flansche	180	29	PN 16	-10	130	GG/CI	S/E	84	optional	55
CL 100-160/2B		DN 100	flanges/flansche	210	34	PN 16	-10	130	GG/CI	S/E	91	optional	55

TEHNICAL DATA / TECHNISCHE DATEN

pump type pumpentyp	code artikelnummer	connection size rohranschluss DN (")	connection type rohranschluss	max. flow durchfluss Q (m ³ /h)	max. pressure druck H (m)	system pressure systemdruck PN (bar)	min. media temp. des medius T min. °C	max. media temp. des medius T max. °C	casing type werkstoffe GG / Cast iron	single-S, double-D einzelne-E, zwillings- bauform-Z	weight gewicht (kg)	regulation geregelt yes / ja no / nein	degree of protection schutzart IP
CL 100-200/2D		DN 100	flanges/flansche	180	42	PN 16	-10	130	GG/CI	S/E	153	optional	55
CL 100-200/2C		DN 100	flanges/flansche	190	47	PN 16	-10	130	GG/CI	S/E	195	optional	55
CL 100-200/2B		DN 100	flanges/flansche	220	55	PN 16	-10	130	GG/CI	S/E	213	optional	55
CL 100-200/2A		DN 100	flanges/flansche	230	57	PN 16	-10	130	GG/CI	S/E	220	optional	55
CL 100-250/2D		DN 100	flanges/flansche	210	69	PN 16	-10	130	GG/CI	S/E	135	optional	55

TEHNIICAL DATA / TECHNISCHE DATEN

pump type pumpentyp	code artikelnummer	connection size rohranschluss DN (")	connection type rohranschluss	max. flow durchfluss Q (m ³ /h)	max. pressure druck H (m)	system pressure systemdruck PN (bar)	min. media temp. des mediums T min. °C	max. media temp. des mediums T max. °C	casing type werkstoffe GG / Cast iron	single-S, double-D einzelne-E, zwillings- bauform-Z	weight gewicht (kg)	regulation geregelt yes /ja no /nein	degree of protection schutzart IP
CLD 40-125 /4Z		DN 40	flanges/flansche	7,5	4	PN 16	-10	130	GG/CI	D/Z	41	optional	55
CLD 40-125 /4Y		DN 40	flanges/flansche	9	4,5	PN 16	-10	130	GG/CI	D/Z	41	optional	55
CLD 40-125 /4X		DN 40	flanges/flansche	13	6,5	PN 16	-10	130	GG/CI	D/Z	41	optional	55
CLD 50-125 /4Y		DN 50	flanges/flansche	18	4,5	PN 16	-10	130	GG/CI	D/Z	44	optional	55
CLD 50-125 /4X		DN 50	flanges/flansche	21	6,5	PN 16	-10	130	GG/CI	D/Z	46	optional	55
CLD 50-160 /4X		DN 50	flanges/flansche	22	9	PN 16	-10	130	GG/CI	D/Z	52	optional	55
CLD 65-160 /4Z		DN 65	flanges/flansche	30	6,5	PN 16	-10	130	GG/CI	D/Z	65	optional	55
CLD 65-160 /4Y		DN 65	flanges/flansche	36	8,5	PN 16	-10	130	GG/CI	D/Z	65	optional	55
CLD 65-160 /4X		DN 65	flanges/flansche	39	9	PN 16	-10	130	GG/CI	D/Z	67	optional	55
CLD 80-160 /4W		DN 80	flanges/flansche	48	6	PN 16	-10	130	GG/CI	D/Z	72	optional	55
CLD 80-160 /4Z		DN 80	flanges/flansche	54	7,2	PN 16	-10	130	GG/CI	D/Z	74	optional	55
CLD 80-160 /4Y		DN 80	flanges/flansche	62	8,7	PN 16	-10	130	GG/CI	D/Z	79	optional	55
CLD 80-160 /4X		DN 80	flanges/flansche	68	10,3	PN 16	-10	130	GG/CI	D/Z	83	optional	55
CLD 100-200 /4W		DN 100	flanges/flansche	80	8,5	PN 16	-10	130	GG/CI	D/Z	130	optional	55
CLD 100-200 /4Z		DN 100	flanges/flansche	95	10	PN 16	-10	130	GG/CI	D/Z	150	optional	55
CLD 100-200 /4Y		DN 100	flanges/flansche	110	12	PN 16	-10	130	GG/CI	D/Z	140	optional	55
CLD 100-200 /4X		DN 100	flanges/flansche	125	15	PN 16	-10	130	GG/CI	D/Z	170	optional	55
CLD 40-125/2D		DN 40	flanges/flansche	15	13	PN 16	-10	130	GG/CI	D/Z	50	optional	55
CLD 40-125/2C		DN 40	flanges/flansche	18	17	PN 16	-10	130	GG/CI	D/Z	50	optional	55
CLD 40-125/2B		DN 40	flanges/flansche	21	21	PN 16	-10	130	GG/CI	D/Z	52	optional	55
CLD 40-125/2A		DN 40	flanges/flansche	23	24,5	PN 16	-10	130	GG/CI	D/Z	54	optional	55
CLD 50-125/2C		DN 50	flanges/flansche	36	15,5	PN 16	-10	130	GG/CI	D/Z	66	optional	55
CLD 50-125/2B		DN 50	flanges/flansche	39	19	PN 16	-10	130	GG/CI	D/Z	66	optional	55
CLD 50-125/2A		DN 50	flanges/flansche	42	24,5	PN 16	-10	130	GG/CI	D/Z	66	optional	55
CLD 50-160/2B		DN 50	flanges/flansche	35	28	PN 16	-10	130	GG/CI	D/Z	67	optional	55
CLD 50-160/2A		DN 50	flanges/flansche	42	35	PN 16	-10	130	GG/CI	D/Z	86	optional	55
CLD 65-160/2D		DN 65	flanges/flansche	48	21	PN 16	-10	130	GG/CI	D/Z	81	optional	55
CLD 65-160/2C		DN 65	flanges/flansche	54	27	PN 16	-10	130	GG/CI	D/Z	101	optional	55
CLD 65-160/2B		DN 65	flanges/flansche	58	32	PN 16	-10	130	GG/CI	D/Z	108	optional	55
CLD 65-160/2A		DN 65	flanges/flansche	70	37	PN 16	-10	130	GG/CI	D/Z	125	optional	55
CLD 80-160/2D		DN 80	flanges/flansche	105	25	PN 16	-10	130	GG/CI	D/Z	187	optional	55
CLD 80-160/2C		DN 80	flanges/flansche	120	30	PN 16	-10	130	GG/CI	D/Z	175	optional	55
CLD 80-160/2B		DN 80	flanges/flansche	140	37	PN 16	-10	130	GG/CI	D/Z	162	optional	55
CLD 80-160/2A		DN 80	flanges/flansche	150	41	PN 16	-10	130	GG/CI	D/Z	148	optional	55
CLD 100-200/2F		DN 100	flanges/flansche	240	33	PN 16	-10	130	GG/CI	D/Z	230	optional	55
CLD 100-200/2E		DN 100	flanges/flansche	260	38	PN 16	-10	130	GG/CI	D/Z	214	optional	55
CLD 100-200/2D		DN 100	flanges/flansche	180	42	PN 16	-10	130	GG/CI	D/Z	200	optional	55
CLD 100-200/2C		DN 100	flanges/flansche	190	47	PN 16	-10	130	GG/CI	D/Z	214	optional	55
CLD 100-200/2B		DN 100	flanges/flansche	220	55	PN 16	-10	130	GG/CI	D/Z	230	optional	55
CLD 100-200/2A		DN 100	flanges/flansche	230	57	PN 16	-10	130	GG/CI	D/Z	230	optional	55

DIMENSIONS / MAßE

pump type pumpentyp	code artikelnummer	length einbaulänge L (mm)	DN	L	L1	a	b	c	d
CV 32 - 4 / 60	979521359	200	32	200	100	277	164,5	70,5	42
CV 32 - 4 / 70	979521358	200	32	200	100	277	164,5	70,5	42
CV 32 - 4 / 80	979521357	200	32	200	100	277	164,5	70,5	42
CV 32 - 2 / 60	979521356	200	32	200	100	277	164,5	70,5	42
CV 32 - 2 / 70	979521355	200	32	200	100	277	164,5	70,5	42
CV 32 - 2 / 80	979521354	200	32	200	100	277	164,5	70,5	42

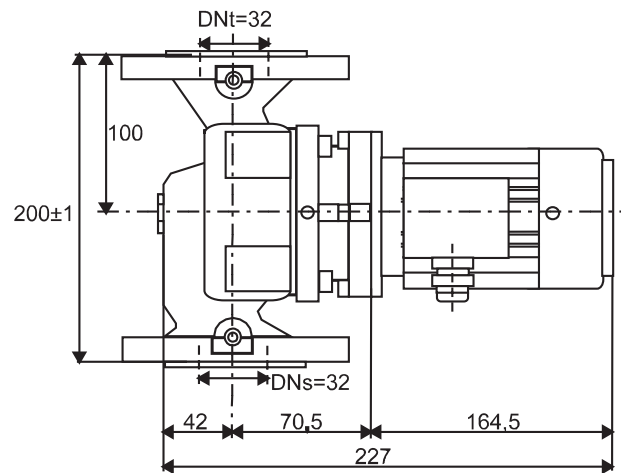

DIMENSIONS / MAßE

2

pump type pumpentyp	code artikelnummer	length einbaulänge L/A (mm)	DN	a/B	f	b1/E	b2/F	h1/I	h2/H	d	h3	l1/C	Pg	l	x
CL 40-140/4	979520741	390	40	90	163	145	135	190	200	200	138	249	16	502	100
CL 40-110/4	979521582	390	40	90	163	145	135	190	200	200	138	249	16	502	100
CL 40-90/4	979522606	360	40	90	155	133	127	180	180	200	130	234	13,5	479	100
CL 40-60/4	979520743	340	40	90	155	113	106	160	180	200	130	234	13,5	479	100
CL 50-140.1/4	979521584	425	50	96	159	150	135	205	220	200	138	274	16	529	100
CL 50-140.2/4	979520744	425	50	96	159	150	135	205	220	200	138	274	16	529	100
CL 50-120.1/4	979521586	425	50	96	159	150	135	205	220	200	138	274	16	529	100
CL 50-120.2/4	979521585	425	50	96	159	150	135	205	220	200	138	274	16	529	100
CL 50-110.1/4	979521588	425	50	96	159	150	135	205	220	200	138	274	16	529	100
CL 50-110.2/4	979521587	425	50	96	159	150	135	205	220	200	138	274	16	529	100
CL 50-100/4	979521589	425	50	96	159	150	135	205	220	200	138	274	16	529	100
CL 50-90/4	979521590	425	50	96	159	150	135	205	220	200	138	274	16	529	100
CL 50-80/4	979520745	380	50	96	159	138	126	180	200	200	138	249	16	504	100
CL 50-70/4	979521591	380	50	96	159	138	126	180	200	200	138	249	16	504	100
CL 50-50/4	979520746	340	50	96	159	240	107	160	180	200	130	234	13,5	489	100
CL 65-150/4	979520747	480	65	95	164	160	140	225	255	250	147	307	16	566	110
CL 65-120/4	979522773	480	65	95	164	160	140	225	255	250	147	307	16	566	110
CL 65-90.1/4	979522772	420	65	95	164	138	125	200	220	200	138	249	16	508	110
CL 65-90.2/4	979520748	420	65	95	164	138	125	200	220	200	138	249	16	508	110
CL 65-70/4	979521617	420	65	95	164	138	125	200	220	200	138	249	16	508	110
CL 65-50/4	979522771	390	65	95	164	135	110	180	210	200	130	234	13,5	493	110
CL 80-140.1/4	979521594	530	80	103	168	183	148	245	285	250	147	307	16	578	120
CL 80-140.2/4	979520750	530	80	103	168	183	148	245	285	250	147	307	16	578	120
CL 80-120/4	979522770	530	80	103	168	183	148	245	285	250	147	307	16	578	120
CL 80-110/4	979521595	530	80	103	168	183	148	245	285	250	147	307	16	578	120
CL 80-100.1/4	979522768	530	80	103	168	183	148	245	285	250	147	307	16	578	120
CL 80-100.2/4	979522769	530	80	103	168	183	148	245	285	250	147	307	16	578	120
CL 80-80.1/4	979522766	480	80	103	168	172	138	220	260	250	147	307	16	578	120
CL 80-80.2/4	979522767	480	80	103	168	172	138	220	260	250	147	307	16	578	120
CL 80-60.1/4	979521596	440	80	103	168	158	124	200	240	200	138	249	16	520	120
CL 80-60.2/4	979520752	440	80	103	168	158	124	200	240	200	138	249	16	520	120
CL 80-40.1/4	979521599	440	80	103	168	158	124	200	240	200	138	249	16	520	120
CL 80-40.2/4	979522764	440	80	103	168	158	124	200	240	200	138	249	16	520	120
CL 100-140.1/4	979521600	560	100	113	169	187	152	270	290	250	162	320	16	602	125
CL 100-140.2/4	979520753	560	100	113	169	187	152	270	290	250	162	320	16	602	125
CL 100-130.1/4	979521602	560	100	113	169	187	152	270	290	250	162	320	16	602	125
CL 100-130.2/4	979521601	560	100	113	169	187	152	270	290	250	162	320	16	602	125
CL 100-110/4	979521603	560	100	113	169	187	152	270	290	250	162	320	16	602	125
CL 100-90/4	979520754	520	100	113	169	180	140	245	275	250	147	307	16	589	125
CL 125-250/4W		745	125	195		195	195	280	340			550			
CL 125-250/4Z		745	125	195		195	195	280	340			550			
CL 125-250/4Y		745	125	195		195	195	280	340			550			
CL 125-250/4X		745	125	195		195	195	280	340			550			
CL 150-250/4W		775	150	220		210	210	330	370			555			
CL 150-250/4V		775	150	220		210	210	330	370			555			
CL 150-250/4Z		775	150	220		210	210	330	370			555			
CL 150-250/4Y		975	150	220		210	210	330	370			755			
CL 150-250/4X		975	150	220		210	210	330	370			755			

DIMENSIONS / MAßE

2

pump type pumpentyp	code artikelnummer	length einbaulänge L/A (mm)	DN	a/B	f	b1/E	b2/F	h1/I	h2/H	d	h3	l1/C	Pg	l	x
CL 401 - 2	979520867	390	40	90	188	145	135	190	200	300	200	361	21	639	100
CL 402 - 2	979520868	360	40	90	155	133	127	180	180	250	162	314	16	559	100
CL 403 - 2	979520869	340	40	90	155	113	106	160	180	250	147	314	16	559	100
CL 501 - 2	979520870	425	50	96	214	150	135	205	220	350	236	479	29	789	100
CL 502 - 2	979520871	380	50	96	184	138	126	180	200	300	200	361	21	641	100
CL 503 - 2	979520872	340	50	96	159	124	107	160	180	250	147	314	16	569	100
CL 651 - 2	979520873	480	65	95	219	160	140	225	255	350	236	521	29	835	110
CL 652 - 2	979520874	420	65	95	189	138	125	200	220	300	200	361	21	611	110
CL 653 - 2	979520875	390	65	95	189	135	110	180	210	300	200	361	21	611	110
CL 801 - 2	979520876	530	80	103	223	183	148	245	284	350	235	550	29	876	120
CL 802 - 2	979520877	480	80	103	223	172	138	225	255	350	236	521	29	847	120
CL 803 - 2	979520878	440	80	103	193	158	124	200	240	300	200	357	21	653	120
CL 32-100/2A		395	65	65		65	107	110	110			330			
CL 40-100/2B		485	65	75		77	107	110	130			330			
CL 40-100/2A		485	65	75		77	107	110	130			330			
CL 40-125/2C		425	65	100		93	107	140	160			325			
CL 40-125/2B		445	65	100		93	118	140	160			345			
CL 40-125/2A		445	65	100		93	118	140	160			345			
CL 40-160/2C		485	80	100		108	149	150	170			385			
CL 40-160/2B		485	80	100		108	149	150	170			385			
CL 40-160/2A		485	80	100		108	149	150	170			385			
CL 40-200/2C		525	80	100		127	159	180	200			425			
CL 40-200/2B		535	80	100		127	159	180	200			425			
CL 40-200/2A		535	80	100		127	159	180	200			425			
CL 50-125/2C		455	80	110		103	118	140	180			345			
CL 50-125/2B		455	80	110		103	118	140	180			345			
CL 50-125/2A		495	80	110		103	118	140	180			385			
CL 50-160/2B		495	80	110		113	149	160	180			385			
CL 50-160/2A		495	80	110		113	149	160	180			385			
CL 50-200/2C		545	80	110		131	159	180	220			435			
CL 50-200/2B		545	100	110		131	159	180	220			435			
CL 50-200/2A		650	100	110		131	184	180	220			540			
CL 65-125/2C		525	100	140		108	149	155	205			385			
CL 65-125/2B		525	100	140		108	149	155	205			385			
CL 65-125/2A		565	100	140		108	159	155	205			425			
CL 65-160/2B		575	100	140		122	159	180	220			435			
CL 65-160/2A		680	125	140		122	184	180	220			540			
CL 65-200/2B		680	125	140		136	184	200	240			540			
CL 65-200/2A		680	125	140		136	184	200	240			540			
CL 80-160/2C		700	125	160		131	184	200	240			540			
CL 80-160/2B		700	150	160		131	184	200	240			540			
CL 80-160/2A		700	150	160		131	184	200	240			540			
CL 80-200/2D		700	150	160		146	184	225	275			540			
CL 80-200/2C		860	150	160		146	229	225	275			700			
CL 80-200/2B		860	150	160		146	229	225	275			700			
CL 100-160/2D		730	100	190		136	184	225	300			540			
CL 100-160/2C		730	100	190		136	184	225	300			540			
CL 100-160/2B		730	100	190		136	184	225	300			540			

DIMENSIONS / MAßE

2

pump type pumpentyp	code artikelnummer	length einbaulänge L/A (mm)	DN	a/B	f	b1/E	b2/F	h1/I	h2/H	d	h3	l1/C	Pg	l	x
CL 100-200/2D		890	100	190		156	230	250	300			700			
CL 100-200/2C		995	100	190		156	257	250	300			805			
CL 100-200/2B		995	100	190		156	257	250	300			805			
CL 100-200/2A		995	100	190		176	257	250	320			805			
CL 100-250/2D		890	100	190		156	230	280	300			700			

2

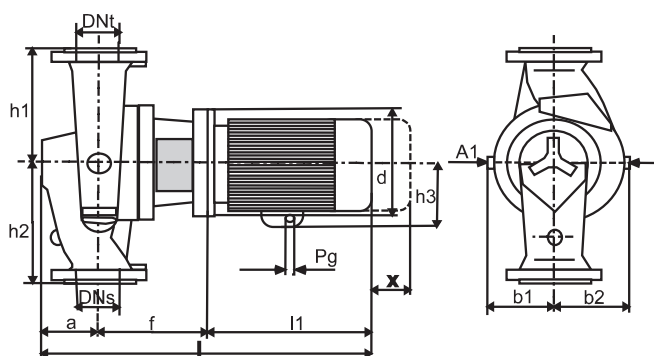

DIMENSIONS / MAßE

pump type pumpentyp	code artikelnummer	DN	A	B	C	D	E	F	G	H	I	L	M
CLD 40-125 /4Z		DN 40	425	100	345	397	200	197	340	130	210	20	100
CLD 40-125 /4Y		DN 40	425	100	345	397	200	197	340	130	210	20	100
CLD 40-125 /4X		DN 40	425	100	345	397	200	197	340	130	210	20	100
CLD 50-125 /4Y		DN 50	435	110	325	427	217	210	365	145	220	22	105
CLD 50-125 /4X		DN 50	435	110	325	427	217	210	365	145	220	22	105
CLD 50-160 /4X		DN 50	435	110	325	480	245	235	410	170	240	22	120
CLD 65-160 /4Z		DN 65	475	130	345	543	275	268	450	180	270	22	140
CLD 65-160 /4Y		DN 65	475	130	345	543	275	268	450	180	270	22	140
CLD 65-160 /4X		DN 65	475	130	345	543	275	268	450	180	270	22	140
CLD 80-160 /4W		DN 80	485	150	385	550	280	270	510	205	305	24	135
CLD 80-160 /4Z		DN 80	485	150	385	550	280	270	510	205	305	24	135
CLD 80-160 /4Y		DN 80	535	150	385	550	280	270	510	205	305	24	135
CLD 80-160 /4X		DN 80	535	150	385	550	280	270	510	205	305	24	135
CLD 100-200 /4W		DN 100	535	180	435	670	325	345	630	240	390	26	165
CLD 100-200 /4Z		DN 100	615	180	435	670	325	345	630	240	390	26	165
CLD 100-200 /4Y		DN 100	615	180	435	670	325	345	630	240	390	26	165
CLD 100-200 /4X		DN 100	615	180	435	670	325	345	630	240	390	26	165
CLD 40-125 /2D		DN 40	445	100	345	397	200	197	340	130	210	20	100
CLD 40-125 /2C		DN 40	445	100	345	397	200	197	340	130	210	20	100
CLD 40-125 /2B		DN 40	425	100	345	397	200	197	340	130	210	20	100
CLD 40-125 /2A		DN 40	425	100	345	397	200	197	340	130	210	20	100
CLD 50-125 /2C		DN 50	495	110	385	427	217	210	365	145	220	22	105
CLD 50-125 /2B		DN 50	495	110	385	427	217	210	365	145	220	22	105
CLD 50-125 /2A		DN 50	495	110	385	427	217	210	365	145	220	22	105
CLD 50-160 /2B		DN 50	495	110	385	480	245	235	410	170	240	22	120
CLD 50-160 /2A		DN 50	535	110	425	480	245	235	410	170	240	22	120
CLD 65-160 /2D		DN 65	515	130	385	543	275	268	450	180	270	22	140
CLD 65-160 /2C		DN 65	565	130	435	543	275	268	450	180	270	22	140
CLD 65-160 /2B		DN 65	565	130	435	543	275	268	450	180	270	22	140
CLD 65-160 /2A		DN 65	670	130	540	543	275	268	450	180	270	22	140
CLD 80-160 /2D		DN 80	640	150	540	550	280	270	510	205	305	24	135
CLD 80-160 /2C		DN 80	690	150	540	550	280	270	510	205	305	24	135
CLD 80-160 /2B		DN 80	690	150	540	550	280	270	510	205	305	24	135
CLD 80-160 /2A		DN 80	690	150	540	550	280	270	510	205	305	24	135
CLD 100-200 /2F		DN 100	720	180	540	670	325	345	630	240	390	26	165
CLD 100-200 /2E		DN 100	720	180	540	670	325	345	630	240	390	26	165
CLD 100-200 /2D		DN 100	720	180	540	670	325	345	630	240	390	26	165
CLD 100-200 /2C		DN 100	720	180	540	670	325	345	630	240	390	26	165
CLD 100-200 /2B		DN 100	720	180	540	670	325	345	630	240	390	26	165
CLD 100-200 /2A		DN 100	720	180	540	670	325	345	630	240	390	26	165



ELECTRICAL DATA / ELEKTRISCHE DATEN



pump type pumpentyp	code artikelnummer	power max. leistungsaufnahme P (W)	speed range drehzahlstufe (min-1)	FLC I nennstrom In (A)	electrical voltage elektroanschluss I (V)	insulating class isolationsklasse
CV 32 - 4 / 60	979521359	180	1335	0,61	3 x 400 V	E
CV 32 - 4 / 70	979521358	180	1335	0,61	3 x 400 V	E
CV 32 - 4 / 80	979521357	180	1335	0,61	3 x 400 V	E
CV 32 - 2 / 60	979521356	250	2800	0,7	3 x 400 V	E
CV 32 - 2 / 70	979521355	250	2800	0,7	3 x 400 V	E
CV 32 - 2 / 80	979521354	250	2800	0,7	3 x 400 V	E

ELECTRICAL DATA / ELEKTRISCHE DATEN



pump type pumpentyp	code artikelnummer	power max. leistungsaufnahme P (W)	speed range drehzahlstufe (min-1)	FLC I nennstrom I _n (A)	electrical voltage elektroanschluss I (V)	insulating class isolationsklasse
CL 40-140/4	979520741	1100	1500	2,8	3 x 400 V	F
CL 40-110/4	979521582	750	1500	2	3 x 400 V	F
CL 40-90/4	979522606	550	1500	1,5	3 x 400 V	F
CL 40-60/4	979520743	550	1500	1,5	3 x 400 V	F
CL 50-140.1/4	979521584	1100	1500	2,8	3 x 400 V	F
CL 50-140.2/4	979520744	1500	1500	3,6	3 x 400 V	F
CL 50-120.1/4	979521586	750	1500	2	3 x 400 V	F
CL 50-120.2/4	979521585	1100	1500	2,8	3 x 400 V	F
CL 50-110.1/4	979521588	750	1500	2	3 x 400 V	F
CL 50-110.2/4	979521587	1100	1500	2,8	3 x 400 V	F
CL 50-100/4	979521589	750	1500	2	3 x 400 V	F
CL 50-90/4	979521590	550	1500	1,5	3 x 400 V	F
CL 50-80/4	979520745	1100	1500	2,8	3 x 400 V	F
CL 50-70/4	979521591	550	1500	1,5	3 x 400 V	F
CL 50-50/4	979520746	550	1500	1,5	3 x 400 V	F
CL 65-150/4	979520747	2200	1500	5	3 x 400 V	F
CL 65-120/4	979522773	1500	1500	3,6	3 x 400 V	F
CL 65-90.1/4	979522772	750	1500	2	3 x 400 V	F
CL 65-90.2/4	979520748	1100	1500	2,8	3 x 400 V	F
CL 65-70/4	979521617	750	1500	2	3 x 400 V	F
CL 65-50/4	979522771	550	1500	1,5	3 x 400 V	F
CL 80-140.1/4	979521594	2200	1500	5	3 x 400 V	F
CL 80-140.2/4	979520750	3000	1500	7,1	3 x 400 V	F
CL 80-120/4	979522770	2200	1500	5	3 x 400 V	F
CL 80-110/4	979521595	2200	1500	5	3 x 400 V	F
CL 80-100.1/4	979522768	1500	1500	3,6	3 x 400 V	F
CL 80-100.2/4	979522769	2200	1500	5	3 x 400 V	F
CL 80-80.1/4	979522766	1500	1500	3,6	3 x 400 V	F
CL 80-80.2/4	979522767	2200	1500	5	3 x 400 V	F
CL 80-60.1/4	979521596	750	1500	2	3 x 400 V	F
CL 80-60.2/4	979520752	1100	1500	2,8	3 x 400 V	F
CL 80-40.1/4	979521599	550	1500	1,5	3 x 400 V	F
CL 80-40.2/4	979522764	750	1500	2	3 x 400 V	F
CL 100-140.1/4	979521600	3000	1500	7,1	3 x 400 V	F
CL 100-140.2/4	979520753	4000	1500	8,6	3 x 400 V	F
CL 100-130.1/4	979521602	2200	1500	5	3 x 400 V	F
CL 100-130.2/4	979521601	3000	1500	7,1	3 x 400 V	F
CL 100-110/4	979521603	2200	1500	5	3 x 400 V	F
CL 100-90/4	979520754	3000	1500	7,1	3 x 400 V	F
CL 125-250/4W		5500	1500	11	3 x 400 V	F
CL 125-250/4Z		5500	1500	11	3 x 400 V	F
CL 125-250/4Y		7500	1500	15	3 x 400 V	F
CL 125-250/4X		9200	1500	19	3 x 400 V	F
CL 150-250/4W		7500	1500	15	3 x 400 V	F
CL 150-250/4V		9200	1500	19	3 x 400 V	F
CL 150-250/4Z		11000	1500	22	3 x 400 V	F
CL 150-250/4Y		15000	1500	30	3 x 400 V	F
CL 150-250/4X		15000	1500	30	3 x 400 V	F

ELECTRICAL DATA / ELEKTRISCHE DATEN



pump type pumpentyp	code artikelnummer	power max. leistungsaufnahme P (W)	speed range drehzahlstufe (min-1)	FLC I nennstrom I _n (A)	electrical voltage elektroanschluss I (V)	insulating class isoliationsklasse
CL 401 - 2	979520867	5500	3000	11,1	3 x 400 V	E
CL 402 - 2	979520868	4000	3000	8,8	3 x 400 V	E
CL 403 - 2	979520869	3000	3000	7,1	3 x 400 V	E
CL 501 - 2	979520870	11000	3000	21	3 x 400 V	E
CL 502 - 2	979520871	5500	3000	11,1	3 x 400 V	E
CL 503 - 2	979520872	3000	3000	7,1	3 x 400 V	E
CL 651 - 2	979520873	15000	3000	28,5	3 x 400 V	E
CL 652 - 2	979520874	7500	3000	14,7	3 x 400 V	E
CL 653 - 2	979520875	5500	3000	11,1	3 x 400 V	E
CL 801 - 2	979520876	22000	3000	35	3 x 400 V	E
CL 802 - 2	979520877	18500	3000	28,5	3 x 400 V	E
CL 803 - 2	979520878	7500	3000	14,7	3 x 400 V	E
CL 32-100/2A		370	3000	0,8	3 x 400 V	F
CL 40-100/2B		550	3000	1,1	3 x 400 V	F
CL 40-100/2A		750	3000	1,5	3 x 400 V	F
CL 40-125/2C		750	3000	1,5	3 x 400 V	F
CL 40-125/2B		1000	3000	2	3 x 400 V	F
CL 40-125/2A		1500	3000	3	3 x 400 V	F
CL 40-160/2C		2000	3000	4	3 x 400 V	F
CL 40-160/2B		3000	3000	6	3 x 400 V	F
CL 40-160/2A		3000	3000	6	3 x 400 V	F
CL 40-200/2C		4000	3000	8	3 x 400 V	F
CL 40-200/2B		5500	3000	11	3 x 400 V	F
CL 40-200/2A		6300	3000	13	3 x 400 V	F
CL 50-125/2C		1500	3000	3	3 x 400 V	F
CL 50-125/2B		2000	3000	4	3 x 400 V	F
CL 50-125/2A		3000	3000	6	3 x 400 V	F
CL 50-160/2B		3000	3000	6	3 x 400 V	F
CL 50-160/2A		4000	3000	8	3 x 400 V	F
CL 50-200/2C		5500	3000	11	3 x 400 V	F
CL 50-200/2B		6300	3000	13	3 x 400 V	F
CL 50-200/2A		7500	3000	15	3 x 400 V	F
CL 65-125/2C		2000	3000	4	3 x 400 V	F
CL 65-125/2B		3000	3000	6	3 x 400 V	F
CL 65-125/2A		4000	3000	8	3 x 400 V	F
CL 65-160/2B		5500	3000	11	3 x 400 V	F
CL 65-160/2A		7500	3000	15	3 x 400 V	F
CL 65-200/2B		10000	3000	20	3 x 400 V	F
CL 65-200/2A		12500	3000	25	3 x 400 V	F
CL 80-160/2C		10000	3000	20	3 x 400 V	F
CL 80-160/2B		12500	3000	25	3 x 400 V	F
CL 80-160/2A		15000	3000	30	3 x 400 V	F
CL 80-200/2D		15000	3000	30	3 x 400 V	F
CL 80-200/2C		18500	3000	37	3 x 400 V	F
CL 80-200/2B		22000	3000	44	3 x 400 V	F
CL 100-160/2D		10000	3000	20	3 x 400 V	F
CL 100-160/2C		12500	3000	25	3 x 400 V	F
CL 100-160/2B		15000	3000	30	3 x 400 V	F

ELECTRICAL DATA / ELEKTRISCHE DATEN



pump type pumpentyp	code artikelnummer	power max. leistungsaufnahme P (W)	speed range drehzahlstufe (min-1)	FLC I nennstrom In (A)	electrical voltage elektroanschluss I (V)	insulating class isolationsklasse
CL 100-200/2D		18500	3000	37	3 x 400 V	F
CL 100-200/2C		22000	3000	44	3 x 400 V	F
CL 100-200/2B		30000	3000	60	3 x 400 V	F
CL 100-200/2A		37000	3000	74	3 x 400 V	F
CL 100-250/2D		37000	3000	74	3 x 400 V	F

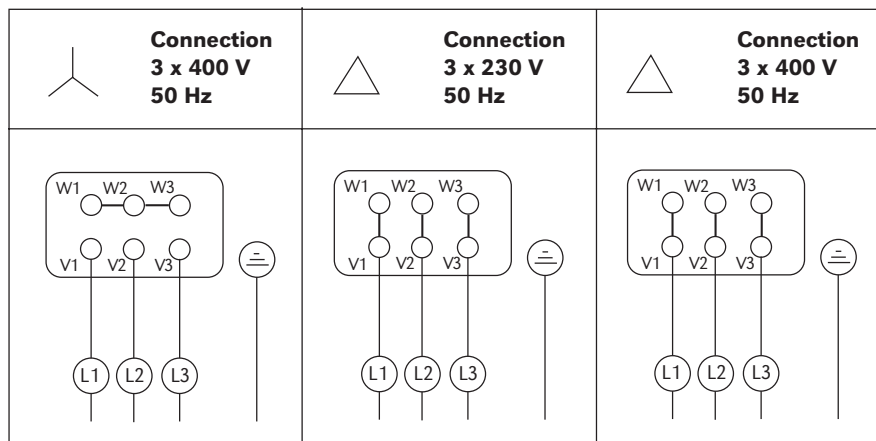

ELECTRICAL DATA / ELEKTRISCHE DATEN



pump type pumpentyp	code artikelnummer	power max. leistungsaufnahme P (W)	speed range drehzahlstufe (min-1)	FLC I nennstrom In (A)	electrical voltage elektroanschluss I (V)	insulating class isolationsklasse
CLD 40-125 /4Z		250	1500	0,5	3 x 400 V	F
CLD 40-125 /4Y		250	1500	0,5	3 x 400 V	F
CLD 40-125 /4X		250	1500	0,5	3 x 400 V	F
CLD 50-125 /4Y		250	1500	0,5	3 x 400 V	F
CLD 50-125 /4X		370	1500	0,8	3 x 400 V	F
CLD 50-160 /4X		500	1500	1	3 x 400 V	F
CLD 65-160 /4Z		550	1500	1,1	3 x 400 V	F
CLD 65-160 /4Y		750	1500	1,5	3 x 400 V	F
CLD 65-160 /4X		900	1500	1,8	3 x 400 V	F
CLD 80-160 /4W		750	1500	1,5	3 x 400 V	F
CLD 80-160 /4Z		900	1500	1,8	3 x 400 V	F
CLD 80-160 /4Y		1100	1500	2,2	3 x 400 V	F
CLD 80-160 /4X		1500	1500	3	3 x 400 V	F
CLD 100-200 /4W		1500	1500	3	3 x 400 V	F
CLD 100-200 /4Z		2200	1500	4,4	3 x 400 V	F
CLD 100-200 /4Y		3000	1500	6	3 x 400 V	F
CLD 100-200 /4X		4000	1500	8	3 x 400 V	F
CLD 40-125/2D		550	3000	1,1	3 x 400 V	F
CLD 40-125/2C		750	3000	1,5	3 x 400 V	F
CLD 40-125/2B		1000	3000	2	3 x 400 V	F
CLD 40-125/2A		1500	3000	3	3 x 400 V	F
CLD 50-125/2C		1500	3000	3	3 x 400 V	F
CLD 50-125/2B		2000	3000	4	3 x 400 V	F
CLD 50-125/2A		3000	3000	6	3 x 400 V	F
CLD 50-160/2B		3000	3000	6	3 x 400 V	F
CLD 50-160/2A		4000	3000	8	3 x 400 V	F
CLD 65-160/2D		3000	3000	6	3 x 400 V	F
CLD 65-160/2C		4000	3000	8	3 x 400 V	F
CLD 65-160/2B		5500	3000	11	3 x 400 V	F
CLD 65-160/2A		7500	3000	15	3 x 400 V	F
CLD 80-160/2D		7500	3000	15	3 x 400 V	F
CLD 80-160/2C		10000	3000	20	3 x 400 V	F
CLD 80-160/2B		12500	3000	25	3 x 400 V	F
CLD 80-160/2A		15000	3000	30	3 x 400 V	F
CLD 100-200/2F		12500	3000	25	3 x 400 V	F
CLD 100-200/2E		15000	3000	30	3 x 400 V	F
CLD 100-200/2D		10000	3000	20	3 x 400 V	F
CLD 100-200/2C		12500	3000	25	3 x 400 V	F
CLD 100-200/2B		15000	3000	30	3 X 400 V	F
CLD 100-200/2A		15000	3000	30	3 x 400 V	F

CB

CB



Block pumps / Trockenläuferpumpen



Block pumps Blockpumpen

TEHNICAL FEATURES / TECHNISCHE MERKMALE		CB
Connections / Nenweite	DN (")	40 do 80
Connection type / Rohranschluss		Flanges / Flansche
Flow max / Förderstrom max	Q (m ³ /h)	160
Pressure max / Förderhöhe	H (m)	60
Pressure rated / Betriebsdruck	PN (bar)	8 / 10
Power max / Leistungsaufnahme max	P (W)	22000
Electrical voltage / Elektroanschluss	V	3 x 400 AC
Degree of protection / Schutzart	IP	54
Regulation / Regelung		no / nein
Media temperature / Temperaturbereich	T(°C)	-15 do +140
Insulating class / Isolationsklasse		E
Casing type / Werkstoffe		GG / Cast iron
Duble pump / Zwillingspumpe		no / nein
APPLICATIONS / EINSATZGEBIETE		
Heating / Warmwasserheizungen		✓
Cooling / Kaltwasseranlagen		✓
Sanitary water / Brauchwasser		
Climate appliances / Klimaanlage		✓
Industry / Industrieanlagen		✓
Process technique / Verfahrenstechnik		✓
Condensation / Kondensat		✓
Salt water / Meerwasser		

Pump markings / Typenschlüssel

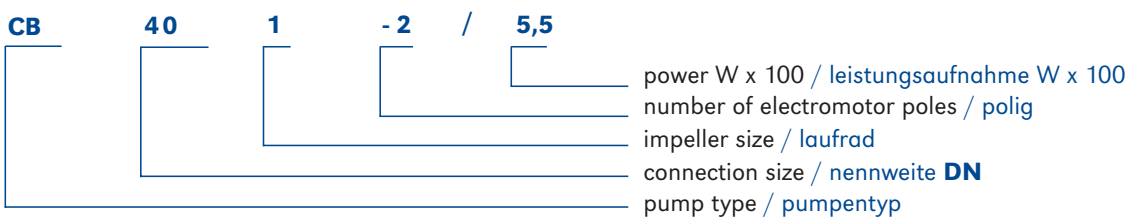

Permitted mounting positions / Einbaumöglichkeiten

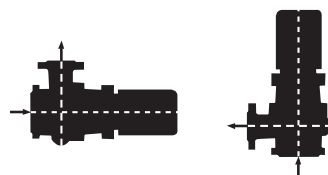

Block pumps
Blockpumpen

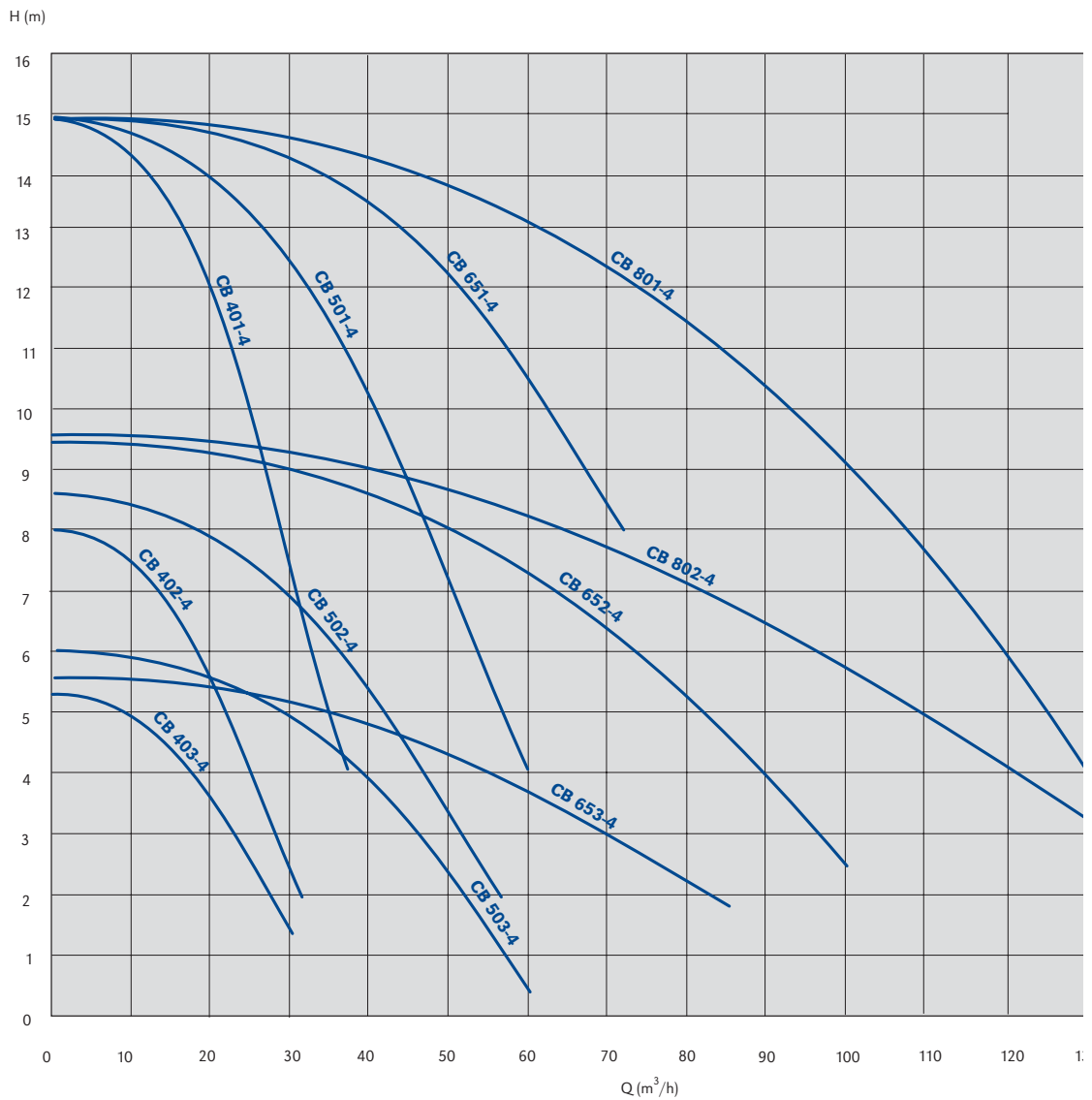
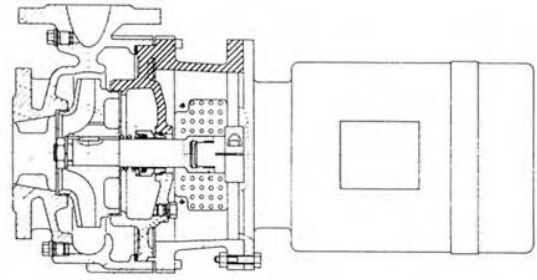
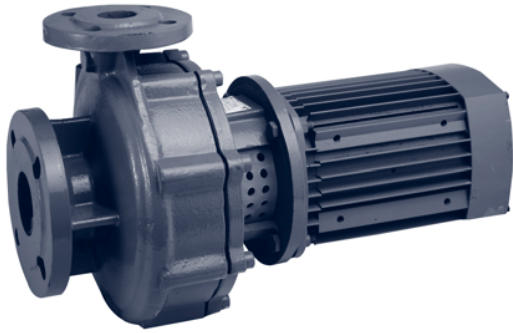

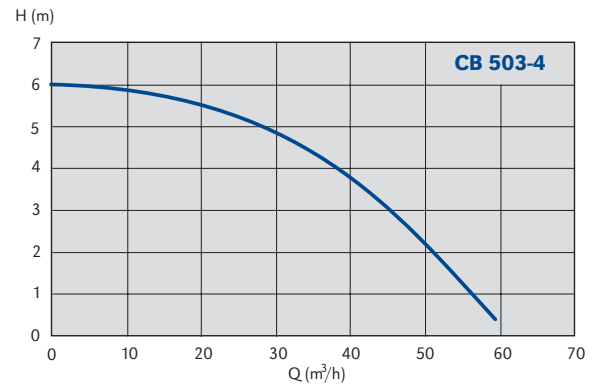
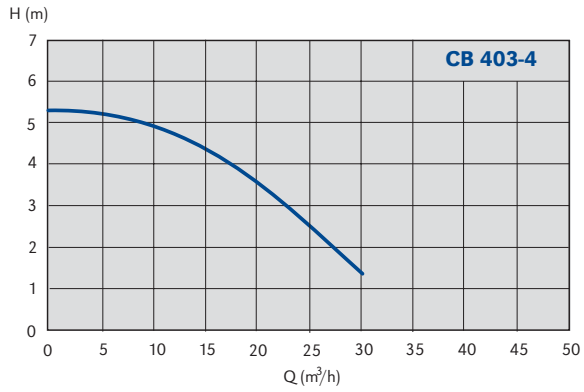
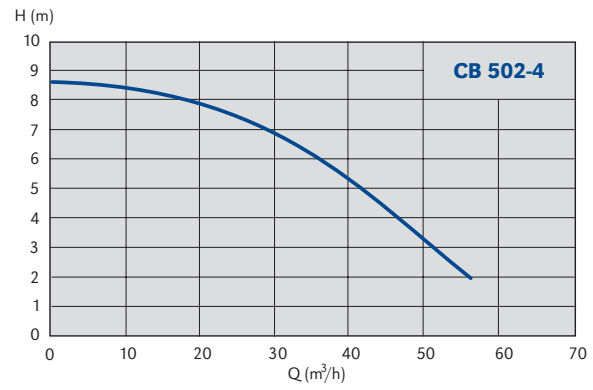
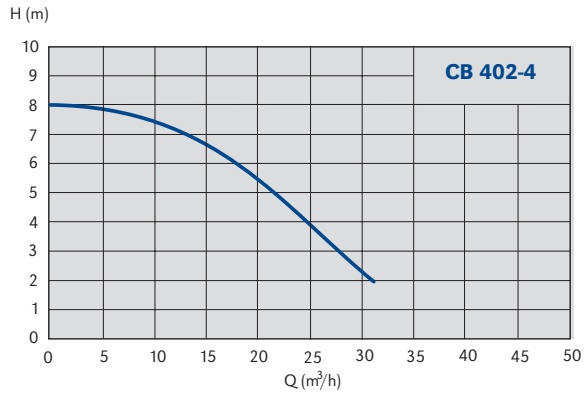
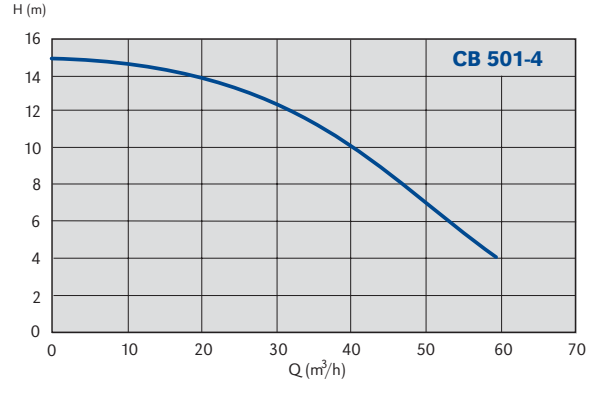
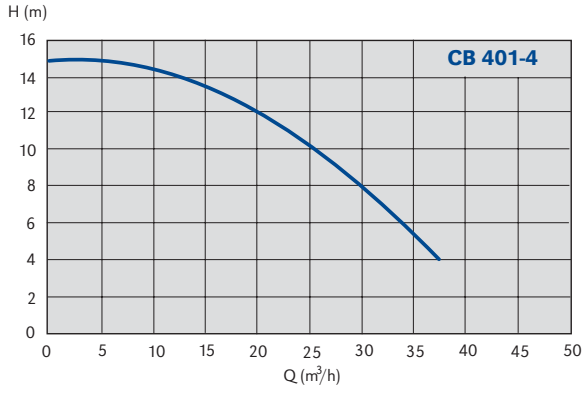

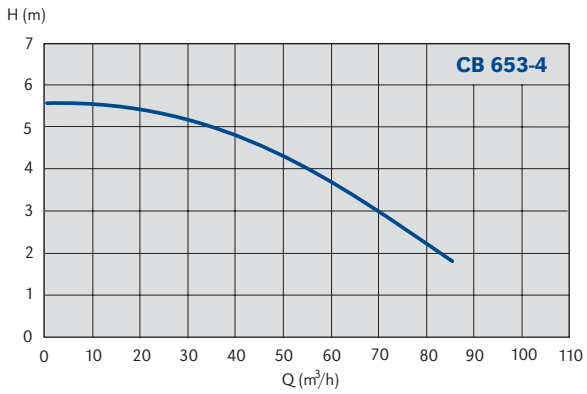
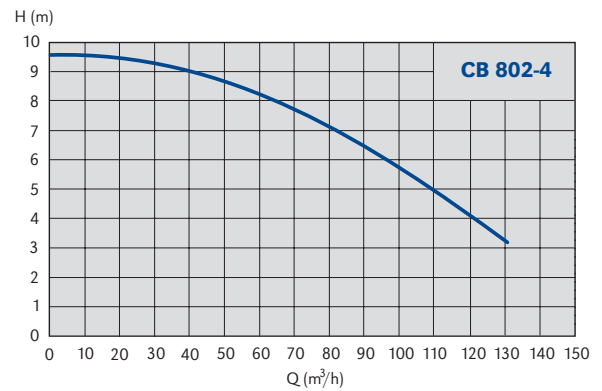
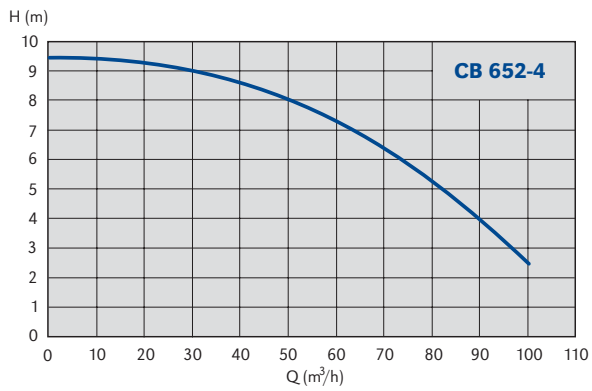
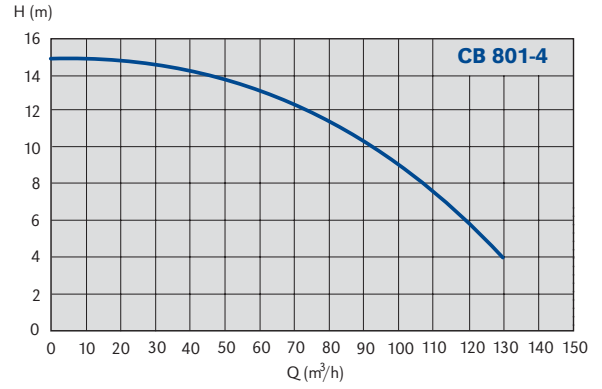
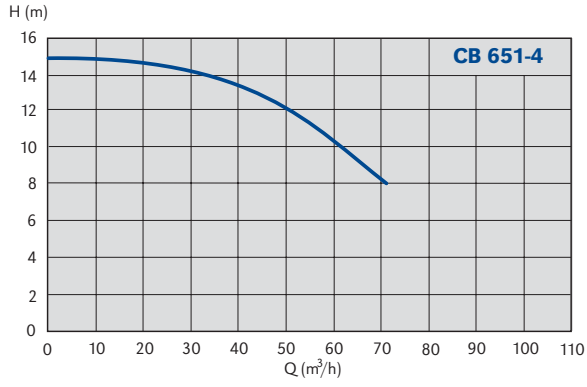

Block pumps
Blockpumpen

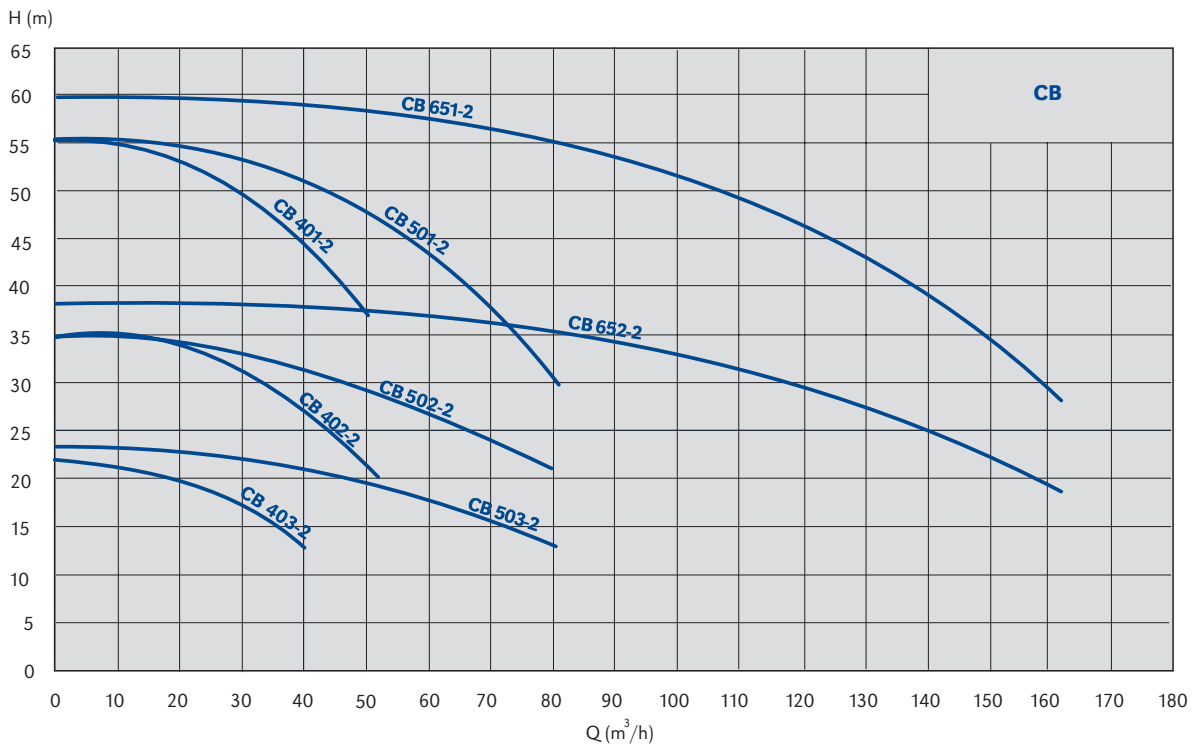
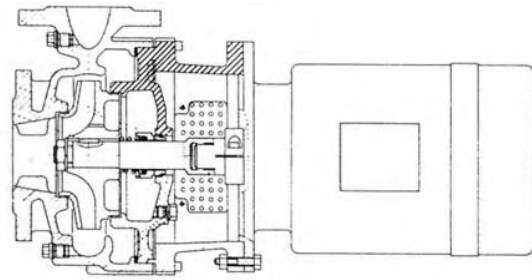
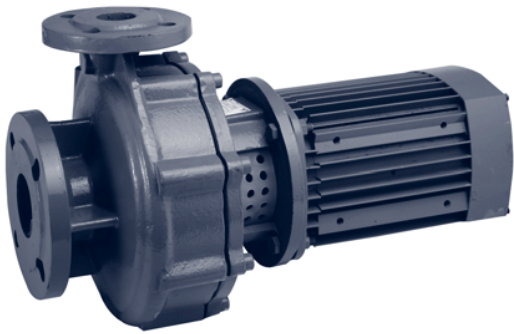

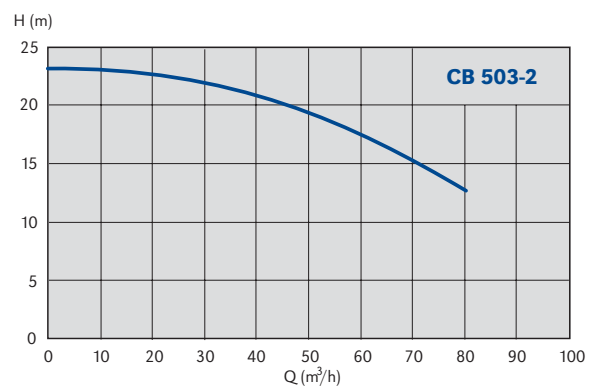
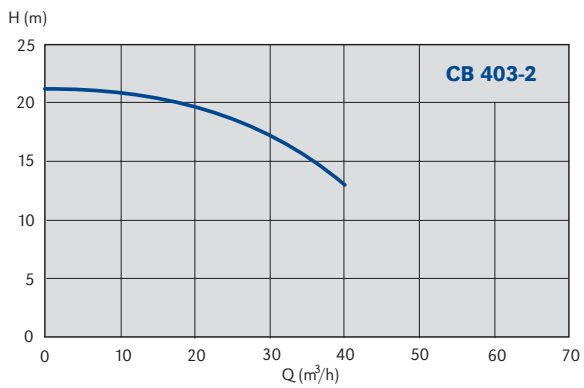
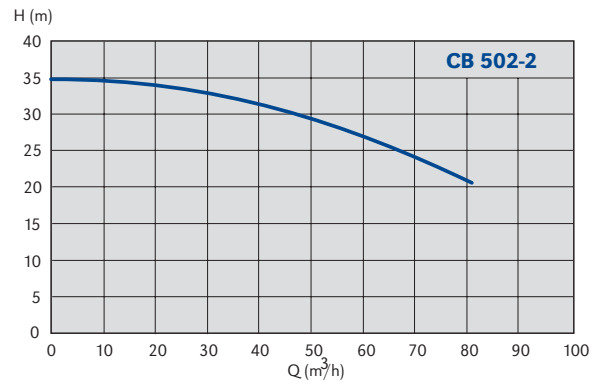
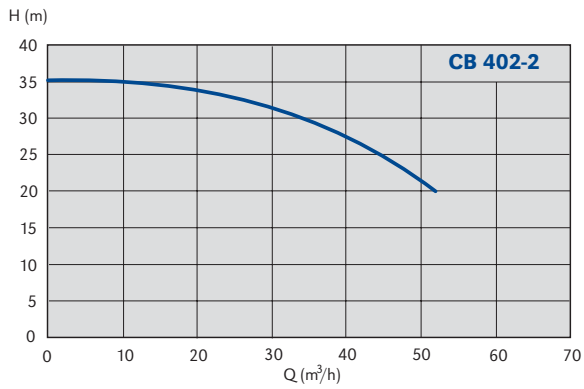
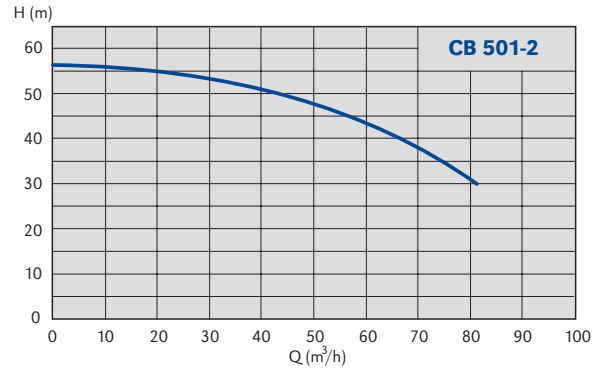
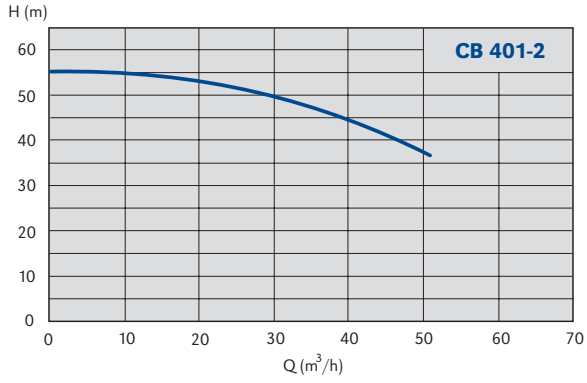

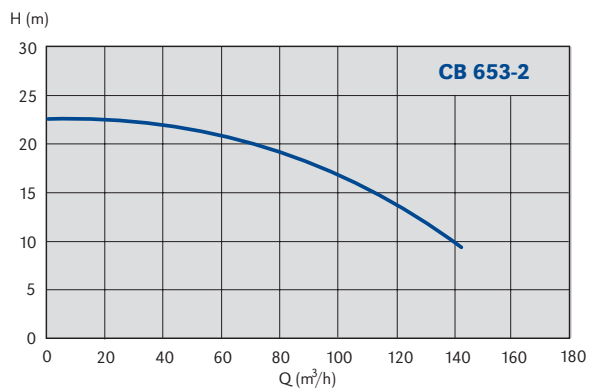
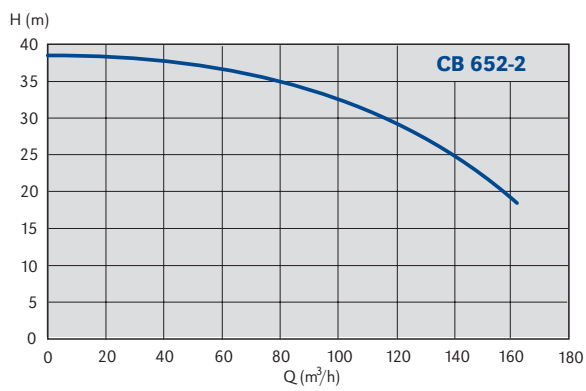
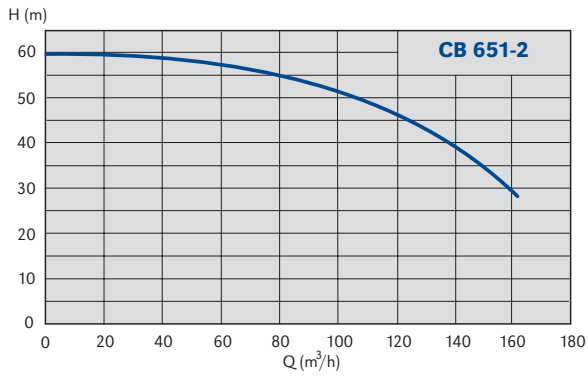

TEHNICAL DATA / TECHNISCHE DATEN

pump type pumpentyp	code artikelnummer	connection size rohranschluss DN (")	connection type rohranschluss	max. flow durchfluss Q (m ³ /h)	max. pressure druck H (m)	system pressure systemdruck PN (bar)	min. media temp. des medius T min. °C	max. media temp. des medius T max. °C	casing type werkstoffe GG/ Cast iron	single-S, double-D einzelne-E, zwillings- bauform-Z	weight gewicht (kg)	regulation geregelt yes /ja no /nein	degree of protection schutzart IP
CB 401 - 4	979520710	DN 40	flanges/flansche	36	15	PN 16	-15	140	GG/CI	S/E	42,5	optional	54
CB 402 - 4	979520711	DN 40	flanges/flansche	30	8	PN 16	-15	140	GG/CI	S/E	31	optional	54
CB 403 - 4	979520712	DN 40	flanges/flansche	30	5	PN 16	-15	140	GG/CI	S/E	39	optional	54
CB 501 - 4	979520713	DN 50	flanges/flansche	60	15	PN 16	-15	140	GG/CI	S/E	54	optional	54
CB 502 - 4	979520714	DN 50	flanges/flansche	50	8	PN 16	-15	140	GG/CI	S/E	44	optional	54
CB 503 - 4	979520715	DN 50	flanges/flansche	50	6	PN 16	-15	140	GG/CI	S/E	36	optional	54
CB 651 - 4	979520716	DN 65	flanges/flansche	90	15	PN 16	-15	140	GG/CI	S/E	64	optional	54
CB 652 - 4	979520717	DN 65	flanges/flansche	90	9	PN 16	-15	140	GG/CI	S/E	60	optional	54
CB 653 - 4	979520718	DN 65	flanges/flansche	90	5,5	PN 16	-15	140	GG/CI	S/E	42	optional	54
CB 801 - 4	979520719	DN 80	flanges/flansche	135	15	PN 16	-15	140	GG/CI	S/E	71	optional	54
CB 802 - 4	979520720	DN 80	flanges/flansche	135	9	PN 16	-15	140	GG/CI	S/E	72	optional	54
CB 401 - 2	979520471	DN 40	flanges/flansche	55	57	PN 16	-15	140	GG/CI	S/E	125	optional	54
CB 402 - 2	979520472	DN 40	flanges/flansche	47	32	PN 16	-15	140	GG/CI	S/E	68	optional	54
CB 403 - 2	979520473	DN 40	flanges/flansche	42	22	PN 16	-15	140	GG/CI	S/E	63	optional	54
CB 501 - 2	979520474	DN 50	flanges/flansche	100	57	PN 16	-15	140	GG/CI	S/E	151	optional	54
CB 502 - 2	979520475	DN 50	flanges/flansche	72	32	PN 16	-15	140	GG/CI	S/E	95	optional	54
CB 503 - 2	979520476	DN 50	flanges/flansche	72	25	PN 16	-15	140	GG/CI	S/E	72	optional	54
CB 651 - 2	979520477	DN 65	flanges/flansche	180	57	PN 16	-15	140	GG/CI	S/E	200	optional	54
CB 652 - 2	979520478	DN 65	flanges/flansche	180	37	PN 16	-15	140	GG/CI	S/E	170	optional	54
CB 653 - 2	979520479	DN 65	flanges/flansche	140	23	PN 16	-15	140	GG/CI	S/E	100	optional	54

DIMENSIONS / MAßE

pump type pumpentyp	code artikelnummer	length einbaulänge L (mm)	DN	DNt	a	f	b1	b2	h1	h2	a1	d	h3	l1	Pg	l	x
CB 401 - 4	979520710	180	65	40	100	158	128	135	182	180	200	180	138	274	16	532	100
CB 402 - 4	979520711	160	65	40	80	158	123	123	182	160	200	180	138	249	16	487	100
CB 403 - 4	979520712	140	65	40	80	158	99	105	182	140	200	157	130	234	13,5	472	100
CB 501 - 4	979520713	200	65	50	100	163	127	143	182	200	250	200	147	307	16	570	110
CB 502 - 4	979520714	180	65	50	100	163	123	130	182	180	200	180	138	249	16	511	110
CB 503 - 4	979520715	160	65	50	100	163	100	117	182	160	200	157	130	234	13,5	497	110
CB 651 - 4	979520716	225	80	65	100	167	133	152	182	225	250	200	147	307	16	574	120
CB 652 - 4	979520717	200	80	65	100	167	123	130	182	200	250	200	147	307	16	574	120
CB 653 - 4	979520718	180	80	65	100	167	105	129	182	180	200	180	138	249	16	516	120
CB 801 - 4	979520719	250	100	80	125	168	144	178	182	250	250	222	162	320	16	613	125
CB 802 - 4	979520720	225	100	80	125	170	131	154	182	225	250	200	147	307	16	602	125
CB 401 - 2	979520471	180	65	40	100	214	128	135	182	180	350	319	236	479	29	793	100
CB 402 - 2	979520472	160	65	40	80	184	123	123	182	160	300	260	200	361	21	625	100
CB 403 - 2	979520473	140	65	40	80	159	99	105	182	140	250	198	147	314	16	553	100
CB 501 - 2	979520474	225	65	50	100	219	127	143	182	225	350	318	236	523	29	842	110
CB 502 - 2	979520475	200	65	50	100	189	123	130	182	200	350	260	200	361	21	650	110
CB 503 - 2	979520476	180	65	50	100	189	100	117	182	180	300	260	200	361	21	650	110
CB 651 - 2	979520477	250	80	65	100	223	133	152	182	250	350	318	235	523	29	846	120
CB 652 - 2	979520478	225	80	65	100	223	123	130	182	225	350	318	236	479	29	802	120
CB 653 - 2	979520479	180	80	65	103	193	105	129	182	180	300	318	200	361	21	657	120

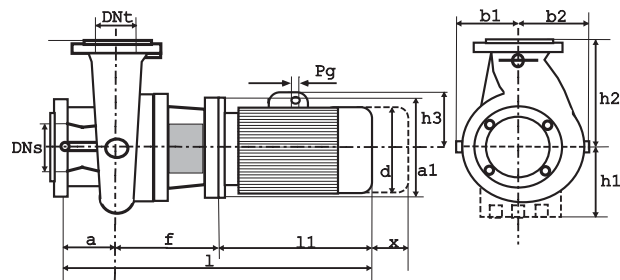

ELECTRICAL DATA / ELEKTRISCHE DATEN

pump type pumpentyp	code artikelnummer	power max. leistungsaufnahme P (W)	speed range drehzahlstufe (min-1)	FLC I nennstrom I _n (A)	electrical voltage elektroanschluss I (V)	insulating class isolationsklasse
CB 401 - 4	979520710	1500	1500	3,8	3 x 400 V	E
CB 402 - 4	979520711	1100	1500	2,9	3 x 400 V	E
CB 403 - 4	979520712	550	1500	1,6	3 x 400 V	E
CB 501 - 4	979520713	2200	1500	5,2	3 x 400 V	E
CB 502 - 4	979520714	1100	1500	2,9	3 x 400 V	E
CB 503 - 4	979520715	750	1500	2,07	3 x 400 V	E
CB 651 - 4	979520716	3000	1500	7,2	3 x 400 V	E
CB 652 - 4	979520717	2200	1500	5,2	3 x 400 V	E
CB 653 - 4	979520718	1100	1500	2,9	3 x 400 V	E
CB 801 - 4	979520719	4000	1500	9,1	3 x 400 V	E
CB 802 - 4	979520720	3000	1500	7,2	3 x 400 V	E
CB 401 - 2	979520471	11000	3000	21	3 x 400 V	E
CB 402 - 2	979520472	5500	3000	11,1	3 x 400 V	E
CB 403 - 2	979520473	3000	3000	7,1	3 x 400 V	E
CB 501 - 2	979520474	15000	3000	28,5	3 x 400 V	E
CB 502 - 2	979520475	7500	3000	14,7	3 x 400 V	E
CB 503 - 2	979520476	5500	3000	11,1	3 x 400 V	E
CB 651 - 2	979520477	22000	3000	35	3 x 400 V	E
CB 652 - 2	979520478	18500	3000	28,5	3 x 400 V	E
CB 653 - 2	979520479	7500	3000	14,7	3 x 400 V	E

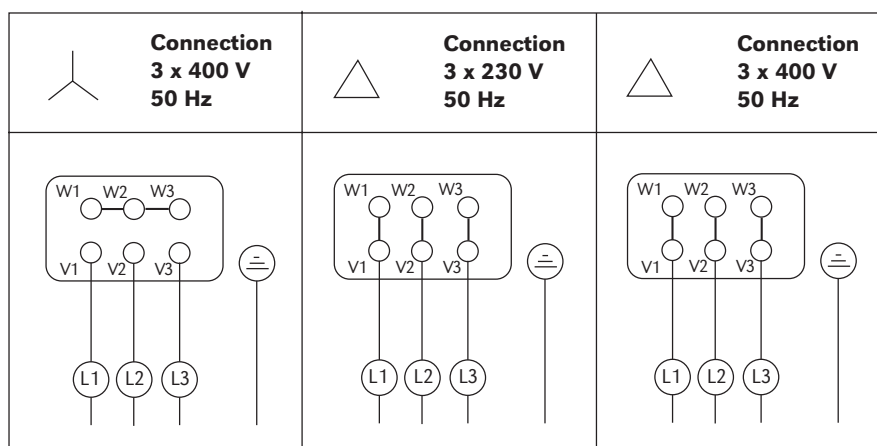



IMPPUMPS

THE HONEST PRODUCT FOR THE HONEST PRICE

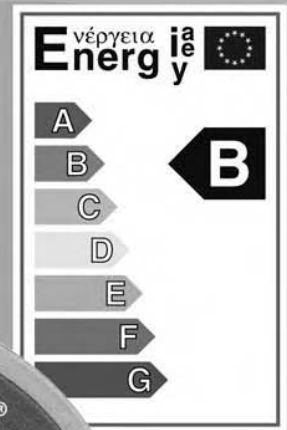

CIRCULATING
PUMP

UMWÄLZPUMPE

PV / CLP

PV / CLP



Circulating pumps for sanitary water /
Brauchwasser Zirkulationspumpen



Circulating pumps for sanitary water Brauchwasser

TEHNIICAL FEATURES / TECHNISCHE MERKMALE		PV	CLP
Connections / Nenweite	DN (")	32	32 do 100
Connection type / Rohranschluss		Flanges / Flansche	Flanges / Flansche
Flow max / Förderstrom max	Q (m ³ /h)	14	160
Pressure max / Förderhöhe	H (m)	6	60
Pressure rated / Betriebsdruck	PN (bar)	10 / 16	8 / 10
Power max / Leistungsaufnahme max	P (W)	250	22000
Electrical voltage / Elektroanschluss	V	3 x 400 AC	3 x 400 AC
Degree of protection / Schutzart	IP	54	54
Regulation / Regelung		no / nien	no / nien
Media temperature / Temperaturbereich	T(°C)	-10 do +110	-15 do +140
Insulating class / Isolationsklasse		E	E
Casing type / Werkstoffe		Bronze / Bronze	Bronze / Bronze
Duble pump / Zwillingspumpe		no / nien	no / nien
APPLICATIONS / EINSATZGEBIETE			
Heating / Warmwasserheizungen		✓	✓
Cooling / Kaltwasseranlagen		✓	✓
Sanitary water / Brauchwasser		✓	✓
Climate appliances / Klimaanlage		✓	✓
Industry / Industrieanlagen		✓	✓
Process technique / Verfahrenstechnik		✓	✓
Condensation / Kondensat			
Salt water / Meerwasser		✓	✓

Pump markings / Typenschlüssel

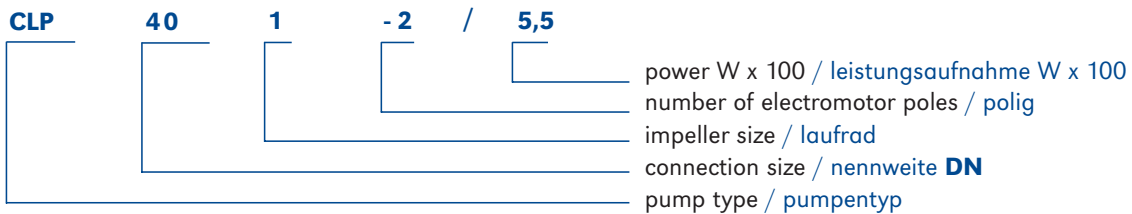
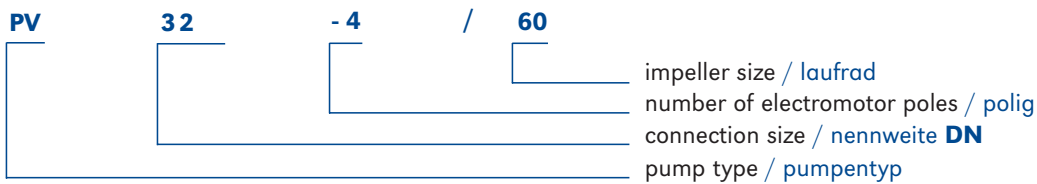

Permitted mounting positions / Einbaumöglichkeiten

PV / CLP

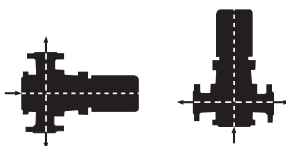

In-line pumps for circulation of sanitary water
Trockenläufer - Inline - Brauchwasserpumpen

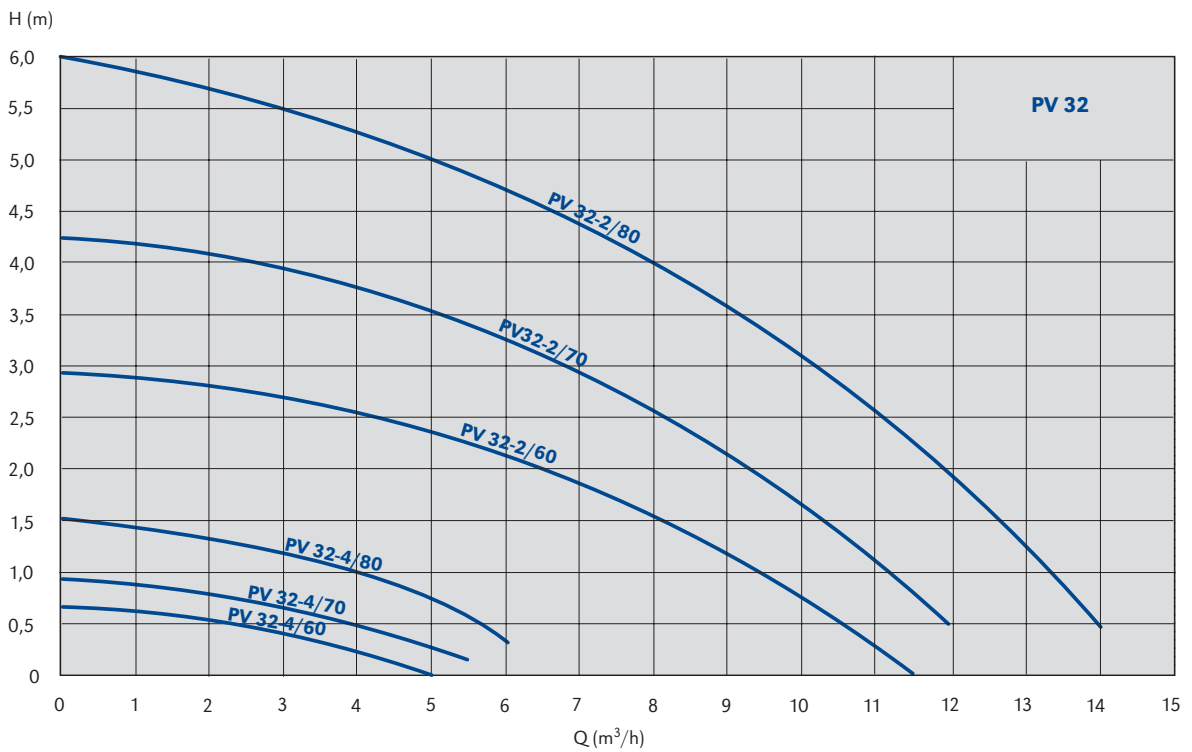
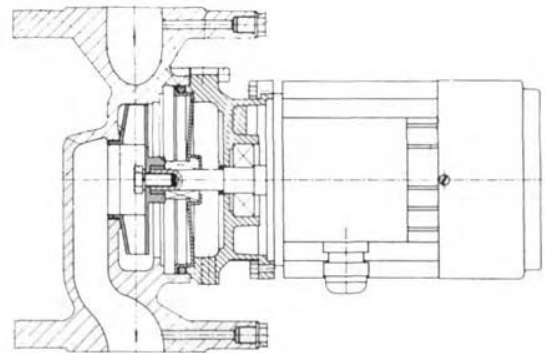
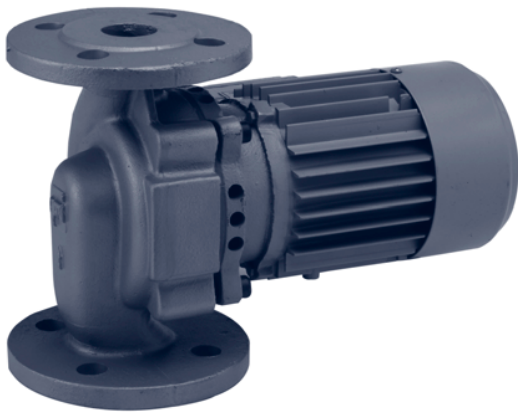

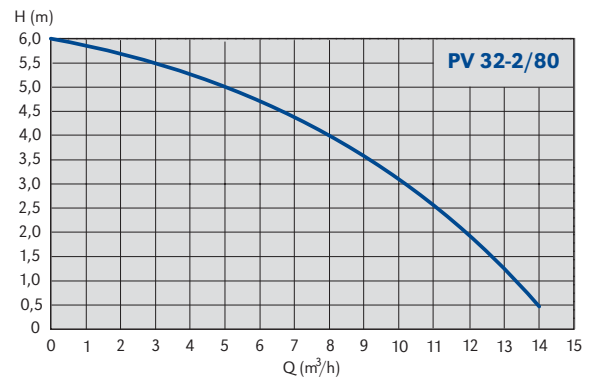
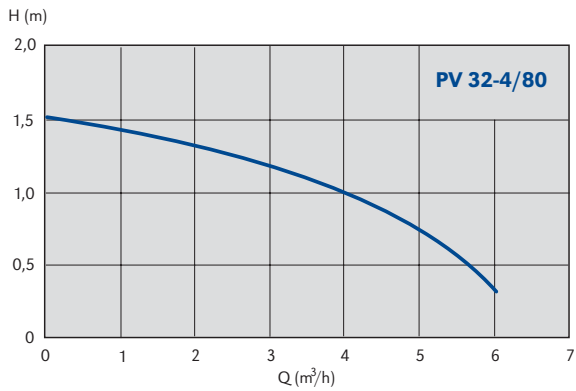
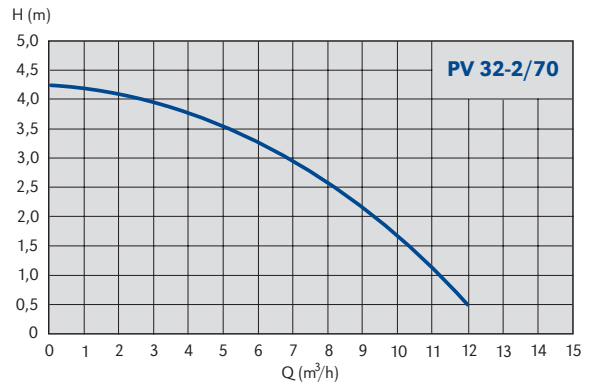
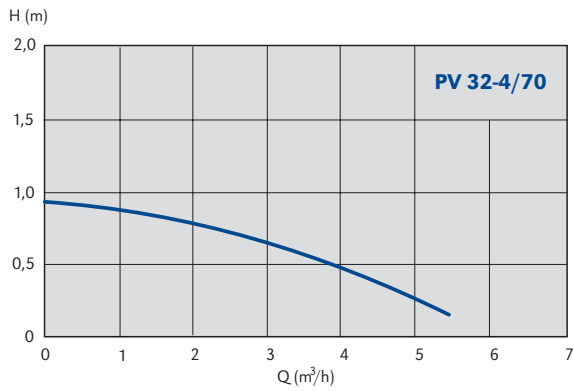
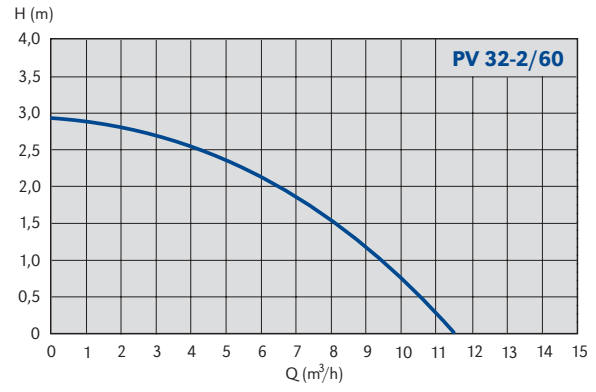
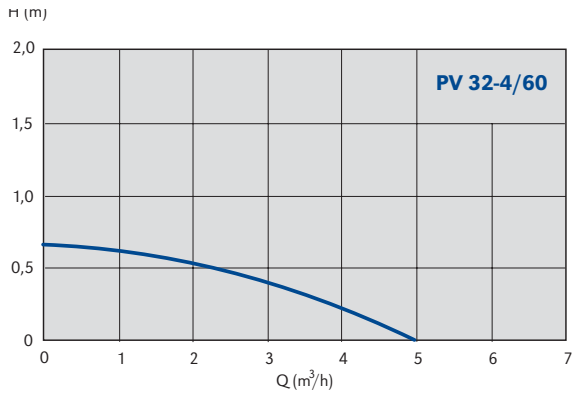

In-line pumps for circulation of sanitary water
Trockenläufer - Inline - Brauchwasserpumpen

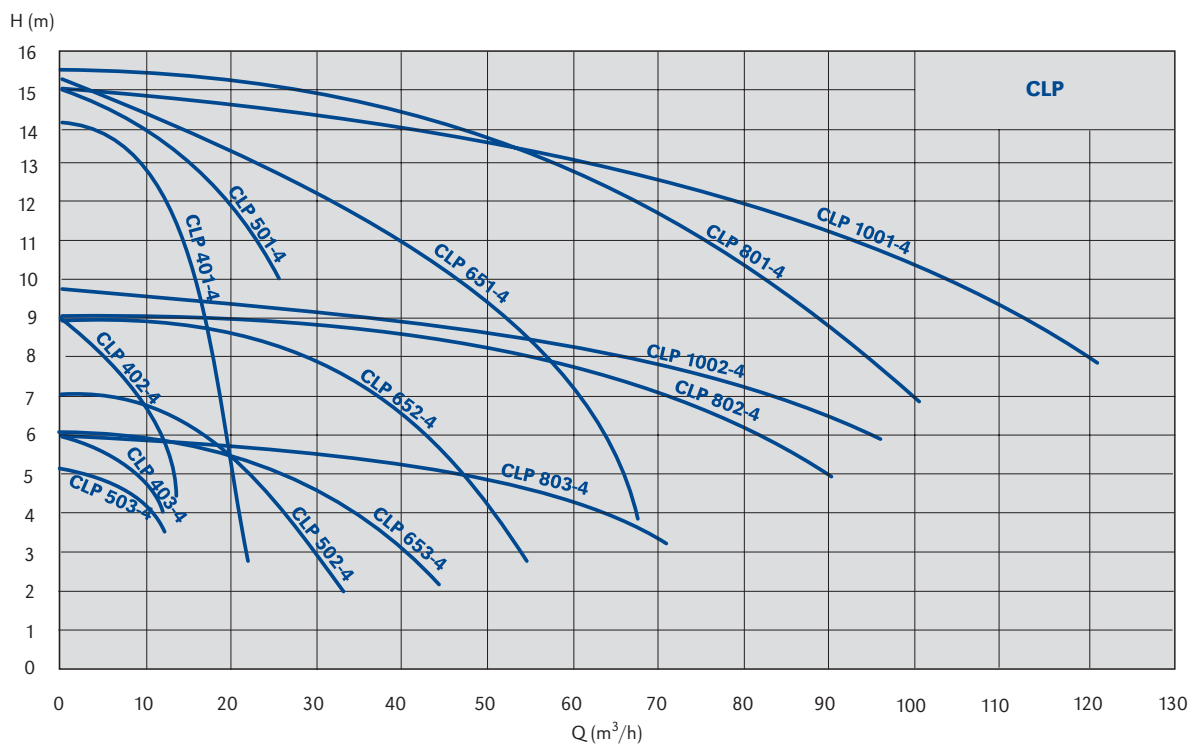
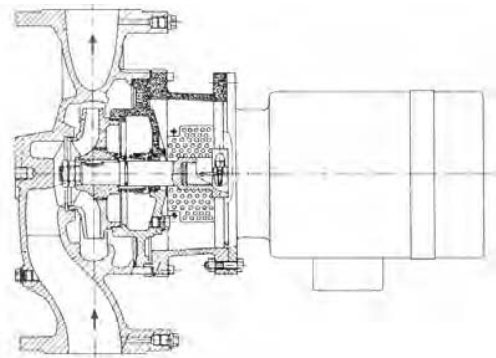
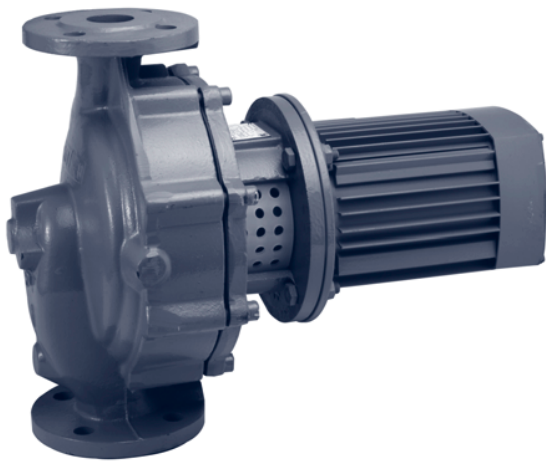

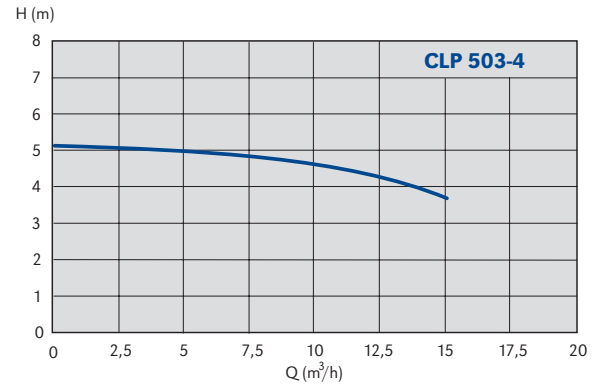
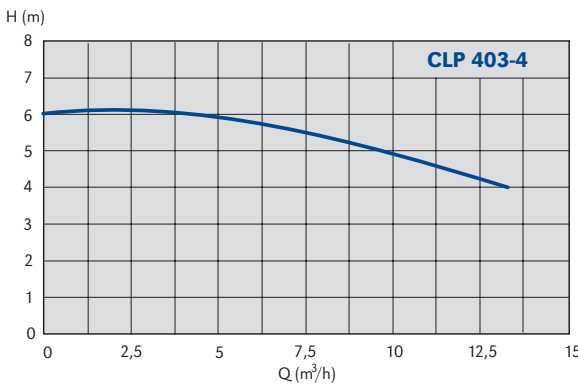
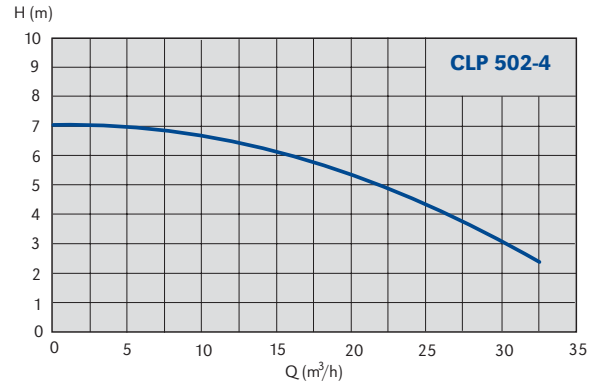
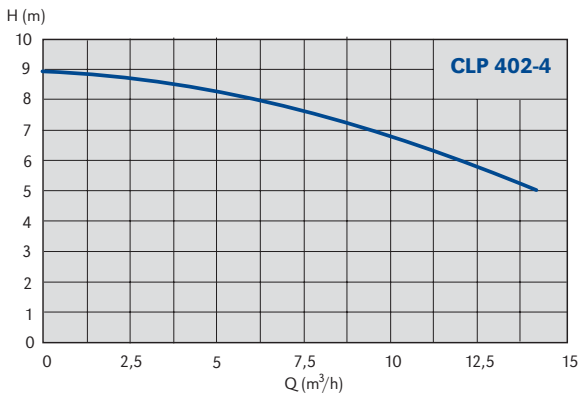
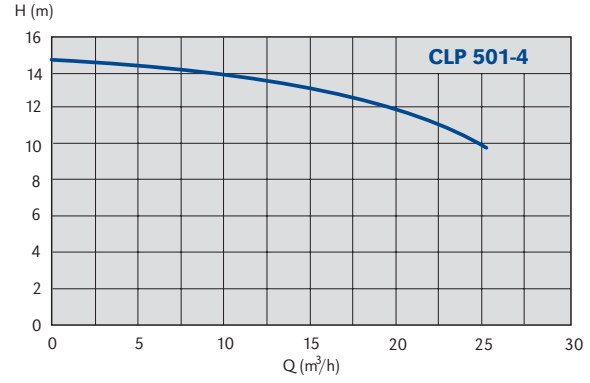
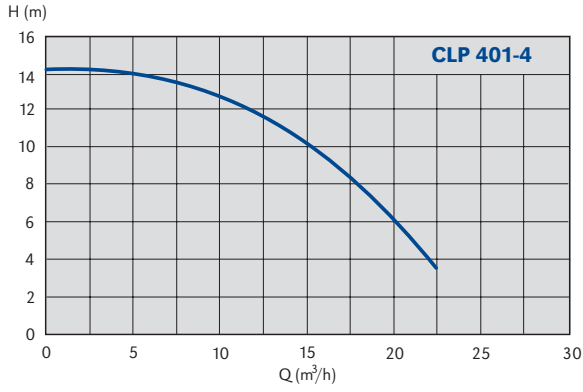

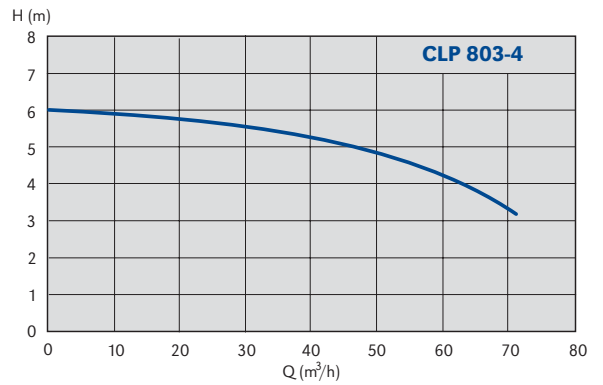
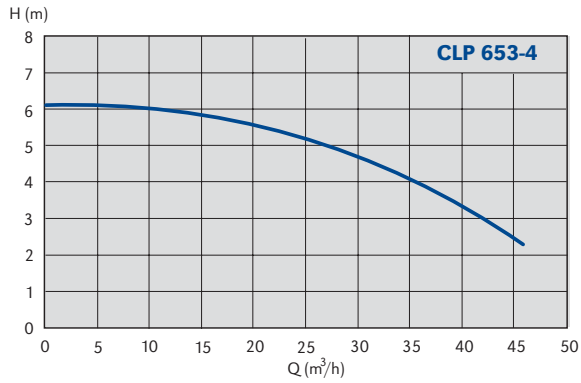
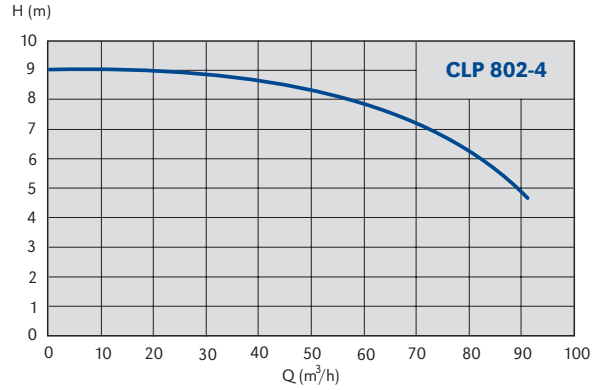
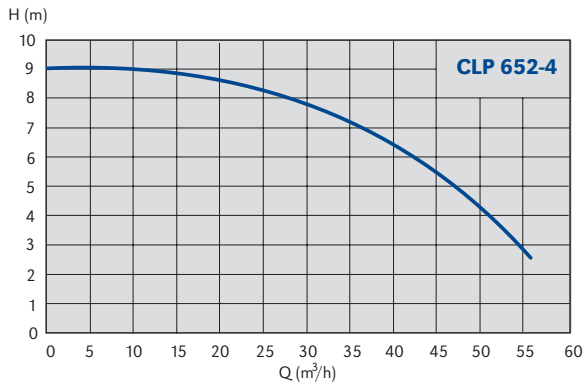
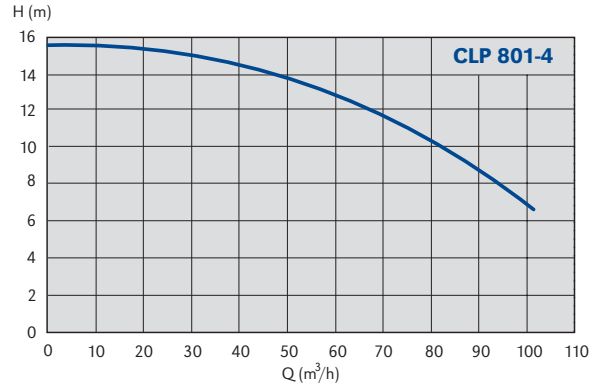
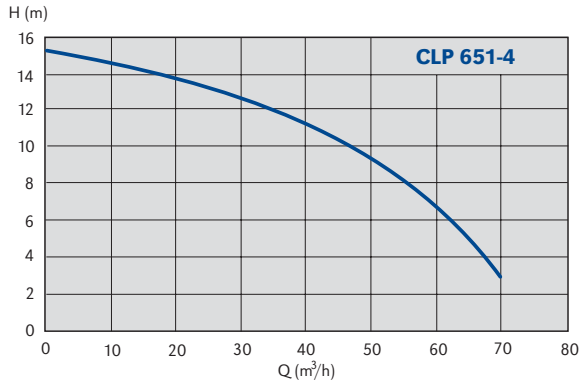

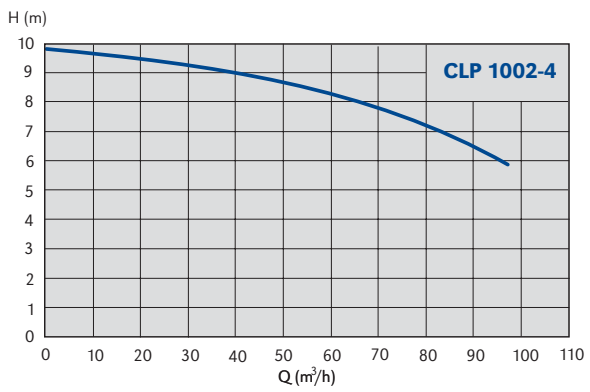
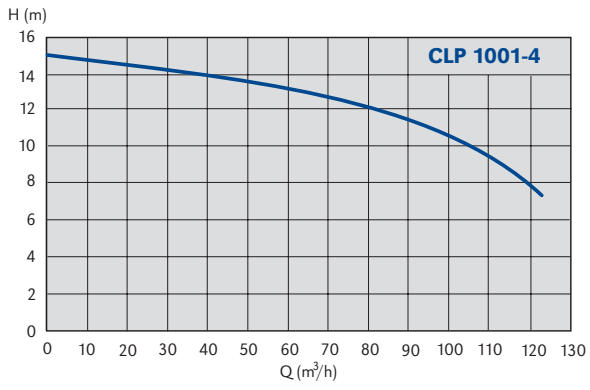

In-line pumps for circulation of sanitary water
Trockenläufer - Inline - Brauchwasserpumpen

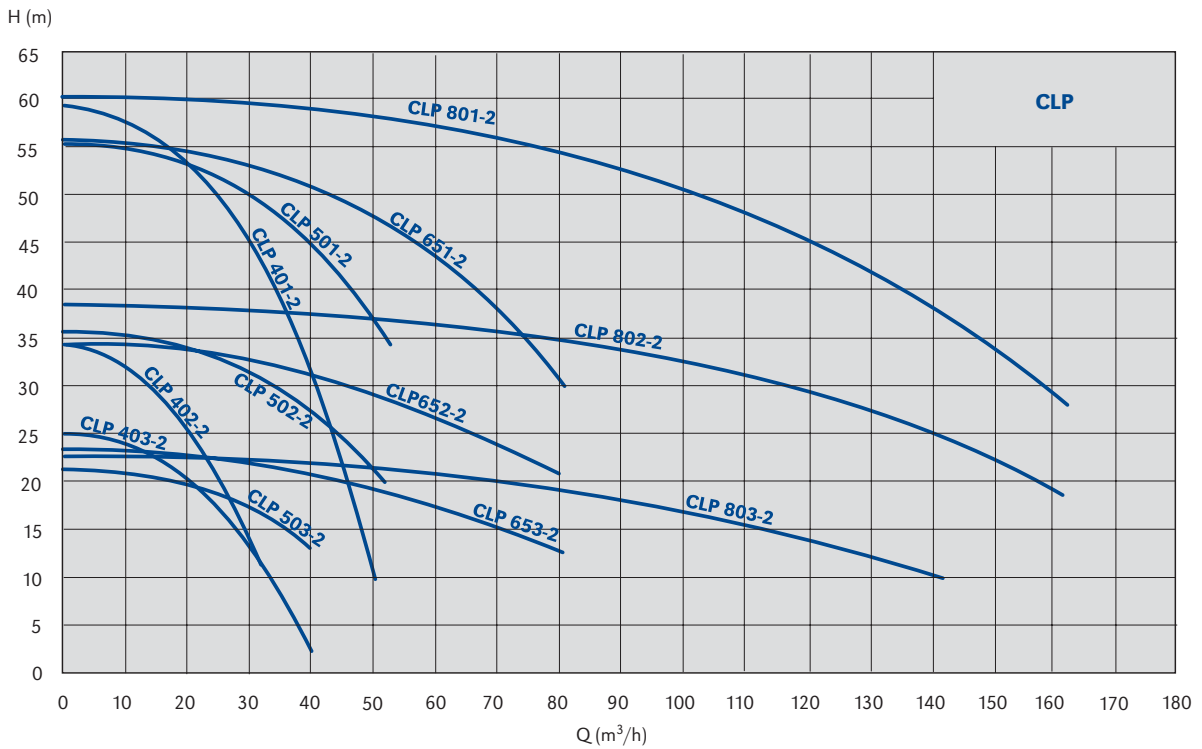
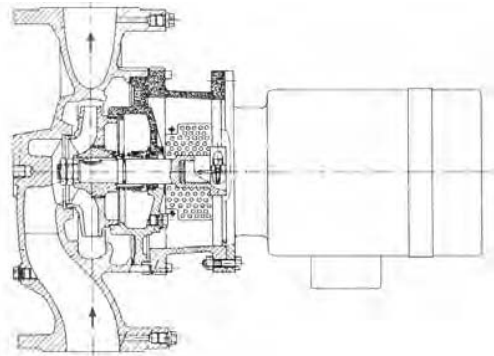
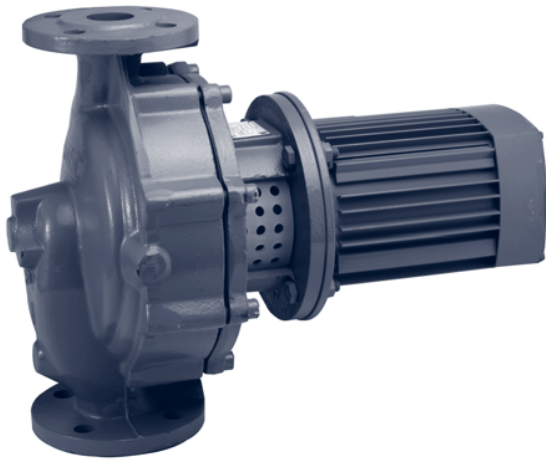

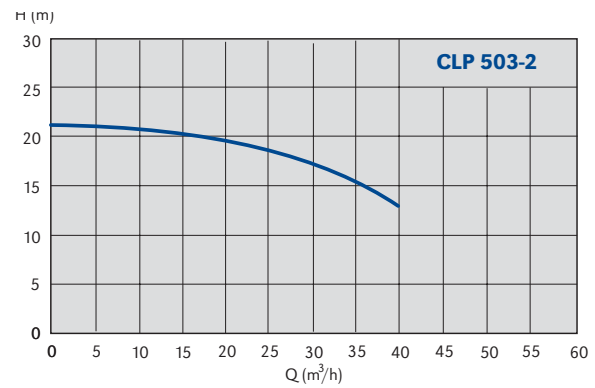
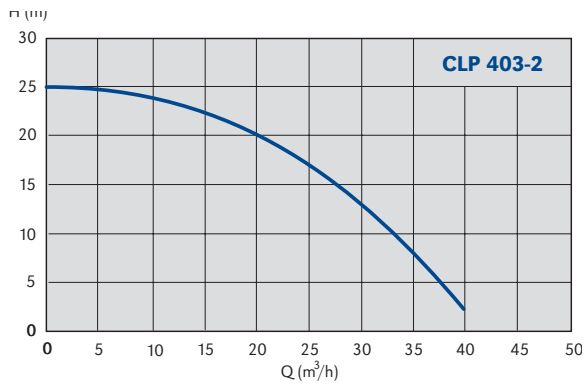
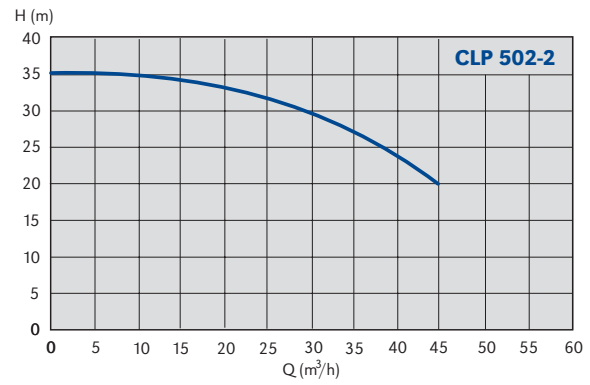
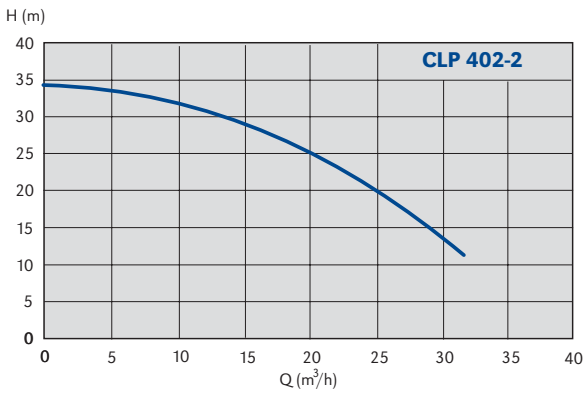
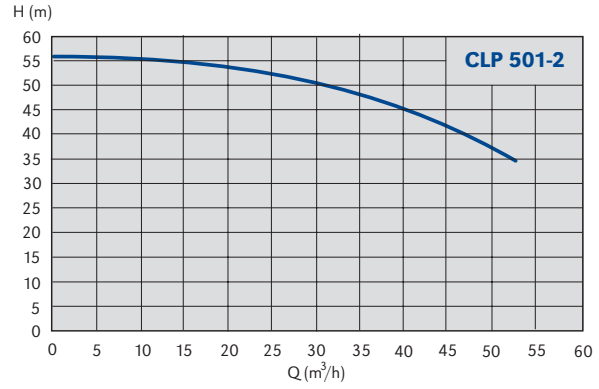
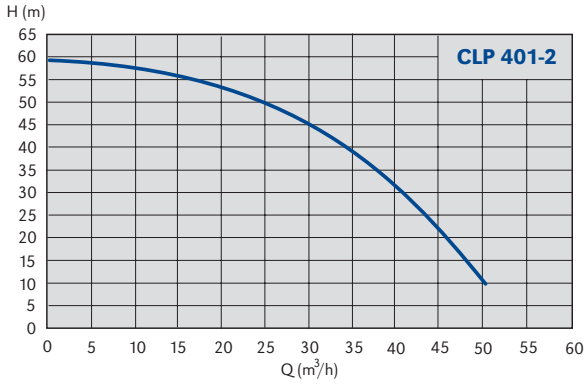

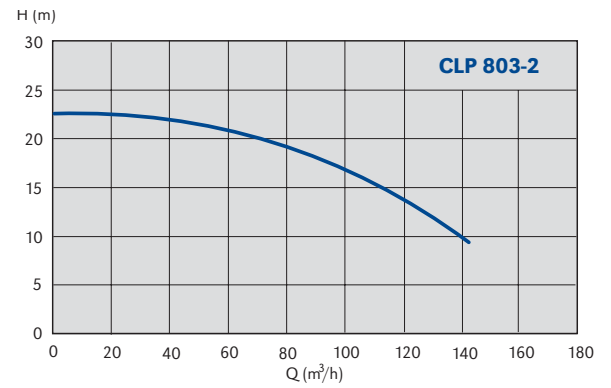
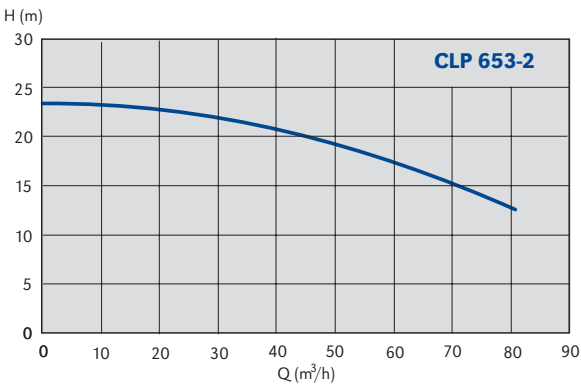
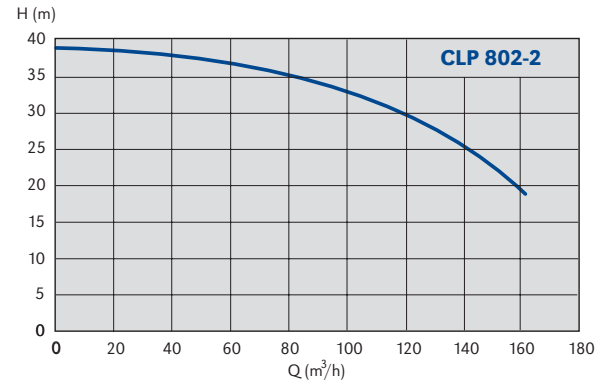
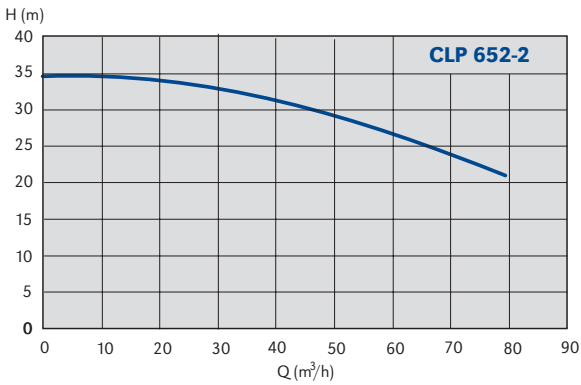
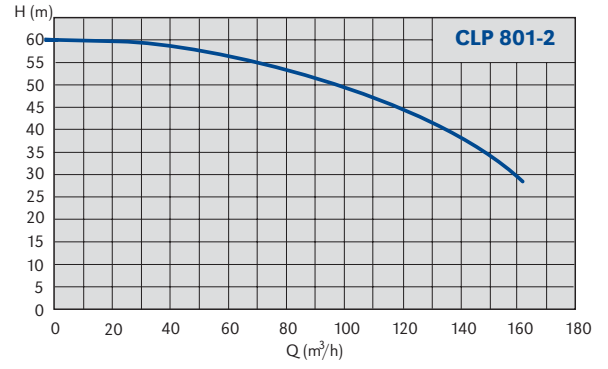
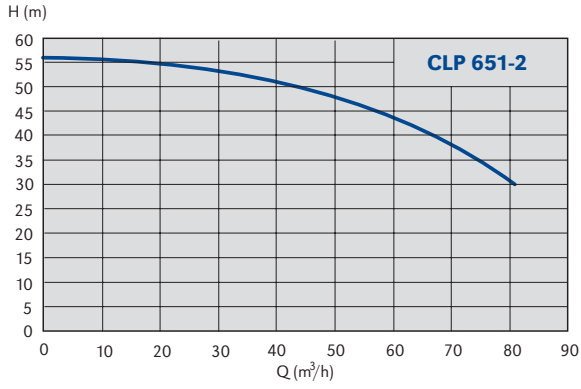

TECHNICAL DATA / TECHNISCHE DATEN

pump type pumpentyp	code artikelnummer	connection size rohranschluss DN (")	connection type rohranschluss	max. flow durchfluss Q (m ³ /h)	max. pressure druck H (m)	system pressure systemdruck PN (bar)	min. media temp. des medius T min. °C	max. media temp. des medius T max. °C	casing type werkstoffe	single-S, double-D einzelne-E, zwillings- bauform-Z	weight gewicht (kg)	regulation geregelt yes /ja no /nein	degree of protection schutzart IP
PV 32 - 4 / 60	979521353	DN 32	flanges/flansche	4	0,6	PN 16	-10	110	bronze	S/E	15	no/nein	54
PV 32 - 4 / 70	979521352	DN 32	flanges/flansche	5	0,9	PN 16	-10	110	bronze	S/E	15	no/nein	54
PV 32 - 4 / 80	979521351	DN 32	flanges/flansche	7	1,5	PN 16	-10	110	bronze	S/E	15	no/nein	54
PV 32 - 2 / 60	979521350	DN 32	flanges/flansche	8	3	PN 16	-10	110	bronze	S/E	15	no/nein	54
PV 32 - 2 / 70	979521349	DN 32	flanges/flansche	9,5	4	PN 16	-10	110	bronze	S/E	15	no/nein	54
PV 32 - 2 / 80	979521348	DN 32	flanges/flansche	13	6	PN 16	-10	110	bronze	S/E	15	no/nein	54
CLP 401 - 4	979520891	DN 40	flanges/flansche	25	15	PN 16	-15	140	bronze	S/E	45	no/nein	54
CLP 402 - 4	979520892	DN 40	flanges/flansche	18	8	PN 16	-15	140	bronze	S/E	40	no/nein	54
CLP 403 - 4	979520893	DN 40	flanges/flansche	18	6	PN 16	-15	140	bronze	S/E	22	no/nein	54
CLP 501 - 4	979520894	DN 50	flanges/flansche	36	15	PN 16	-15	140	bronze	S/E	47	no/nein	54
CLP 502 - 4	979520895	DN 50	flanges/flansche	29	8	PN 16	-15	140	bronze	S/E	44	no/nein	54
CLP 503 - 4	979520896	DN 50	flanges/flansche	29	5	PN 16	-15	140	bronze	S/E	42	no/nein	54
CLP 651 - 4	979520897	DN 65	flanges/flansche	56	15	PN 16	-15	140	bronze	S/E	60	no/nein	54
CLP 652 - 4	979520898	DN 65	flanges/flansche	54	8	PN 16	-15	140	bronze	S/E	48	no/nein	54
CLP 653 - 4	979520899	DN 65	flanges/flansche	54	6	PN 16	-15	140	bronze	S/E	40	no/nein	54
CLP 801 - 4	979520900	DN 80	flanges/flansche	85	15	PN 16	-15	140	bronze	S/E	74	no/nein	54
CLP 802 - 4	979520901	DN 80	flanges/flansche	85	9	PN 16	-15	140	bronze	S/E	66	no/nein	54
CLP 803 - 4	979520902	DN 80	flanges/flansche	80	5,5	PN 16	-15	140	bronze	S/E	51	no/nein	54
CLP 1001 - 4	979520903	DN 100	flanges/flansche	140	15	PN 16	-15	140	bronze	S/E	80	no/nein	54
CLP 1002 - 4	979520904	DN 100	flanges/flansche	140	9,5	PN 16	-15	140	bronze	S/E	79	no/nein	54
CLP 401 - 2	979520962	DN 40	flanges/flansche	13	57	PN 16	-15	140	bronze	S/E	76	no/nein	54
CLP 402 - 2	979520963	DN 40	flanges/flansche	32	32	PN 16	-15	140	bronze	S/E	70	no/nein	54
CLP 403 - 2	979520964	DN 40	flanges/flansche	32	26	PN 16	-15	140	bronze	S/E	38	no/nein	54
CLP 501 - 2	979520965	DN 50	flanges/flansche	54	57	PN 16	-15	140	bronze	S/E	130	no/nein	54
CLP 502 - 2	979520966	DN 50	flanges/flansche	50	32	PN 16	-15	140	bronze	S/E	70	no/nein	54
CLP 503 - 2	979520967	DN 50	flanges/flansche	43	21	PN 16	-15	140	bronze	S/E	66	no/nein	54
CLP 651 - 2	979520968	DN 65	flanges/flansche	100	57	PN 16	-15	140	bronze	S/E	157	no/nein	54
CLP 652 - 2	979520969	DN 65	flanges/flansche	72	32	PN 16	-15	140	bronze	S/E	99	no/nein	54
CLP 653 - 2	979520970	DN 65	flanges/flansche	72	26	PN 16	-15	140	bronze	S/E	76	no/nein	54
CLP 801 - 2	979520971	DN 80	flanges/flansche	160	57	PN 16	-15	140	bronze	S/E	210	no/nein	54
CLP 802 - 2	979520972	DN 80	flanges/flansche	160	38	PN 16	-15	140	bronze	S/E	175	no/nein	54
CLP 803 - 2	979520973	DN 80	flanges/flansche	135	22	PN 16	-15	140	bronze	S/E	103	no/nein	54

DIMENSIONS / MAßE



pump type pumpentyp	code artikelnummer	length einbaulänge L (mm)	DN	L	L1	a	b	c	d
PV 32 - 4 / 60	979521353	200	32	200	100	277	164,5	70,5	42
PV 32 - 4 / 70	979521352	200	32	200	100	277	164,5	70,5	42
PV 32 - 4 / 80	979521351	200	32	200	100	277	164,5	70,5	42
PV 32 - 2 / 60	979521350	200	32	200	100	277	164,5	70,5	42
PV 32 - 2 / 70	979521349	200	32	200	100	277	164,5	70,5	42
PV 32 - 2 / 80	979521348	200	32	200	100	277	164,5	70,5	42

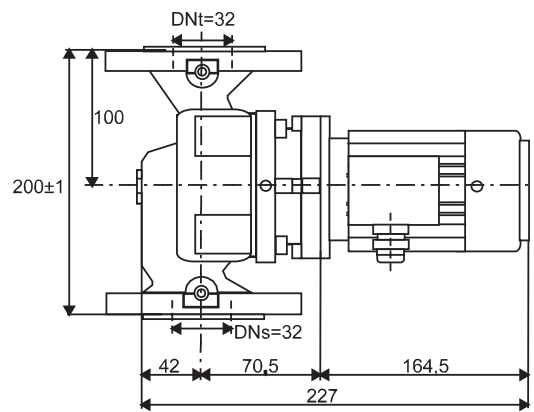

DIMENSIONS / MAßE

2

pump type pumpentyp	code artikelnummer	length einbaulänge L (mm)	DN	a	f	b1	b2	h1	h2	d	h3	l1	Pg	l	x
CLP 401 - 4	979520891	390	40	90	163	145	135	190	200	200	138	249	16	502	100
CLP 402 - 4	979520892	360	40	90	155	133	127	180	180	200	130	234	13,5	479	100
CLP 403 - 4	979520893	340	40	90	155	113	106	160	180	200	130	234	13,5	479	100
CLP 501 - 4	979520894	425	50	96	159	150	135	205	220	200	138	274	16	529	100
CLP 502 - 4	979520895	380	50	96	159	138	126	180	200	200	138	249	16	504	100
CLP 503 - 4	979520896	340	50	96	159	240	107	160	180	200	130	234	13,5	489	100
CLP 651 - 4	979520897	480	65	95	164	160	140	225	255	250	147	307	16	566	110
CLP 652 - 4	979520898	420	65	95	164	138	125	200	220	200	138	249	16	508	110
CLP 653 - 4	979520899	390	65	95	164	135	110	180	210	200	130	234	13,5	493	110
CLP 801 - 4	979520900	530	80	103	168	183	148	245	285	250	147	307	16	578	120
CLP 802 - 4	979520901	480	80	103	168	172	138	220	260	250	147	307	16	578	120
CLP 803 - 4	979520902	440	80	103	168	158	124	200	240	200	138	249	16	520	120
CLP 1001 - 4	979520903	560	100	113	169	187	152	270	290	250	162	320	16	602	125
CLP 1002 - 4	979520904	520	100	113	169	180	140	245	275	250	147	307	16	589	125
CLP 401 - 2	979520962	390	40	90	188	145	135	190	200	300	200	361	21	639	100
CLP 402 - 2	979520963	360	40	90	155	133	127	180	180	250	162	314	16	559	100
CLP 403 - 2	979520964	340	40	90	155	113	106	160	180	250	147	314	16	559	100
CLP 501 - 2	979520965	425	50	96	214	150	135	205	220	350	236	479	29	789	100
CLP 502 - 2	979520966	380	50	96	184	138	126	180	200	300	200	361	21	641	100
CLP 503 - 2	979520967	340	50	96	159	124	107	160	180	250	147	314	16	569	100
CLP 651 - 2	979520968	480	65	95	219	160	140	225	255	350	236	521	29	835	110
CLP 652 - 2	979520969	420	65	95	189	138	125	200	220	300	200	361	21	611	110
CLP 653 - 2	979520970	390	65	95	189	135	110	180	210	300	200	361	21	611	110
CLP 801 - 2	979520971	530	80	103	223	183	148	245	284	350	235	550	29	876	120
CLP 802 - 2	979520972	480	80	103	223	172	138	225	255	350	236	521	29	847	120
CLP 803 - 2	979520973	440	80	103	193	158	124	200	240	300	200	357	21	653	120

2

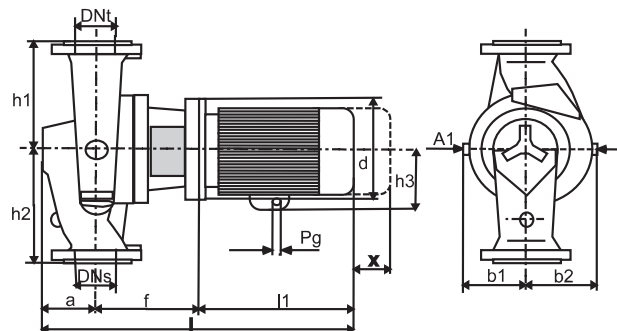

ELECTRICAL DATA / ELEKTRISCHE DATEN

	pump type pumpentyp	code artikelnummer	power max. leistungsaufnahme P (W)	speed range drehzahlstufe (min-1)	FLC I nennstrom In (A)	electrical voltage elektroanschluss I (V)	insulating class isolationsklasse
1	PV 32 - 4 / 60	979521353	180	1335	0,61	3 x 400 V	E
	PV 32 - 4 / 70	979521352	180	1335	0,61	3 x 400 V	E
	PV 32 - 4 / 80	979521351	180	1335	0,61	3 x 400 V	E
2	PV 32 - 2 / 60	979521350	250	2800	0,7	3 x 400 V	E
	PV 32 - 2 / 70	979521349	250	2800	0,7	3 x 400 V	E
	PV 32 - 2 / 80	979521348	250	2800	0,7	3 x 400 V	E
2	CLP 401 - 4	979520891	1100	1500	2,9	3 x 400 V	E
	CLP 402 - 4	979520892	750	1500	2,07	3 x 400 V	E
	CLP 403 - 4	979520893	550	1500	1,6	3 x 400 V	E
	CLP 501 - 4	979520894	1500	1500	3,8	3 x 400 V	E
	CLP 502 - 4	979520895	1100	1500	2,9	3 x 400 V	E
	CLP 503 - 4	979520896	550	1500	1,6	3 x 400 V	E
	CLP 651 - 4	979520897	2200	1500	5,2	3 x 400 V	E
	CLP 652 - 4	979520898	1100	1500	2,9	3 x 400 V	E
	CLP 653 - 4	979520899	750	1500	2,07	3 x 400 V	E
	CLP 801 - 4	979520900	3000	1500	7,2	3 x 400 V	E
	CLP 802 - 4	979520901	2200	1500	5,2	3 x 400 V	E
	CLP 803 - 4	979520902	1100	1500	2,9	3 x 400 V	E
	CLP 1001 - 4	979520903	4000	1500	9,1	3 x 400 V	E
	CLP 1002 - 4	979520904	3000	1500	7,2	3 x 400 V	E
	CLP 401 - 2	979520962	5500	3000	11,1	3 x 400 V	E
	CLP 402 - 2	979520963	4000	3000	8,8	3 x 400 V	E
	CLP 403 - 2	979520964	3000	3000	7,1	3 x 400 V	E
	CLP 501 - 2	979520965	11000	3000	21	3 x 400 V	E
	CLP 502 - 2	979520966	5500	3000	11,1	3 x 400 V	E
	CLP 503 - 2	979520967	3000	3000	7,1	3 x 400 V	E
CLP 651 - 2	979520968	15000	3000	28,5	3 x 400 V	E	
CLP 652 - 2	979520969	7500	3000	14,7	3 x 400 V	E	
CLP 653 - 2	979520970	5500	3000	11,1	3 x 400 V	E	
CLP 801 - 2	979520971	22000	3000	35	3 x 400 V	E	
CLP 802 - 2	979520972	18500	3000	28,5	3 x 400 V	E	
CLP 803 - 2	979520973	7500	3000	14,7	3 x 400 V	E	

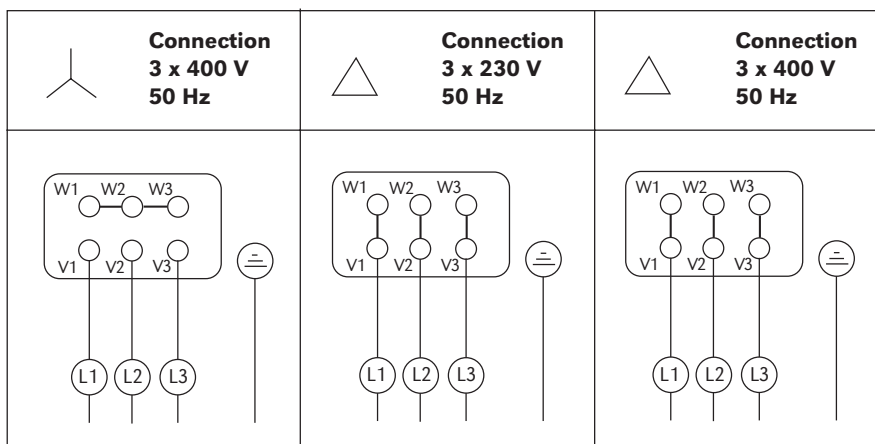
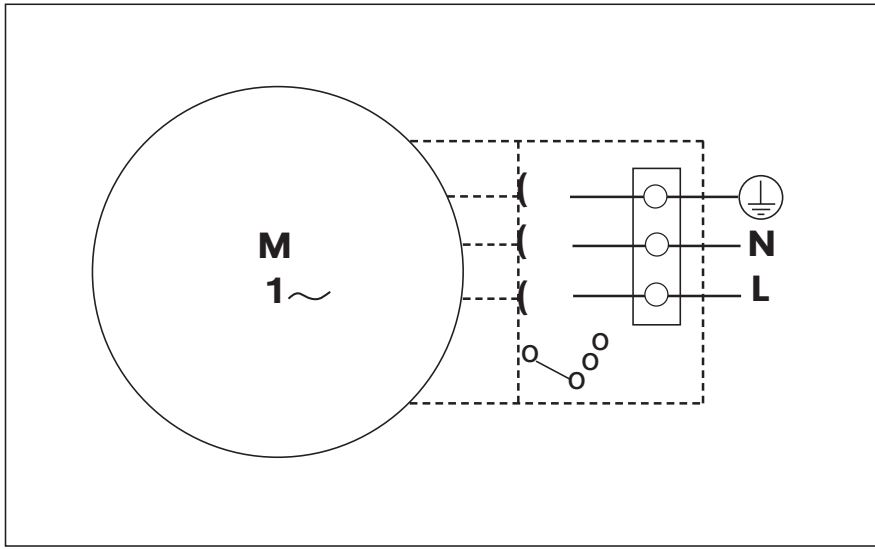

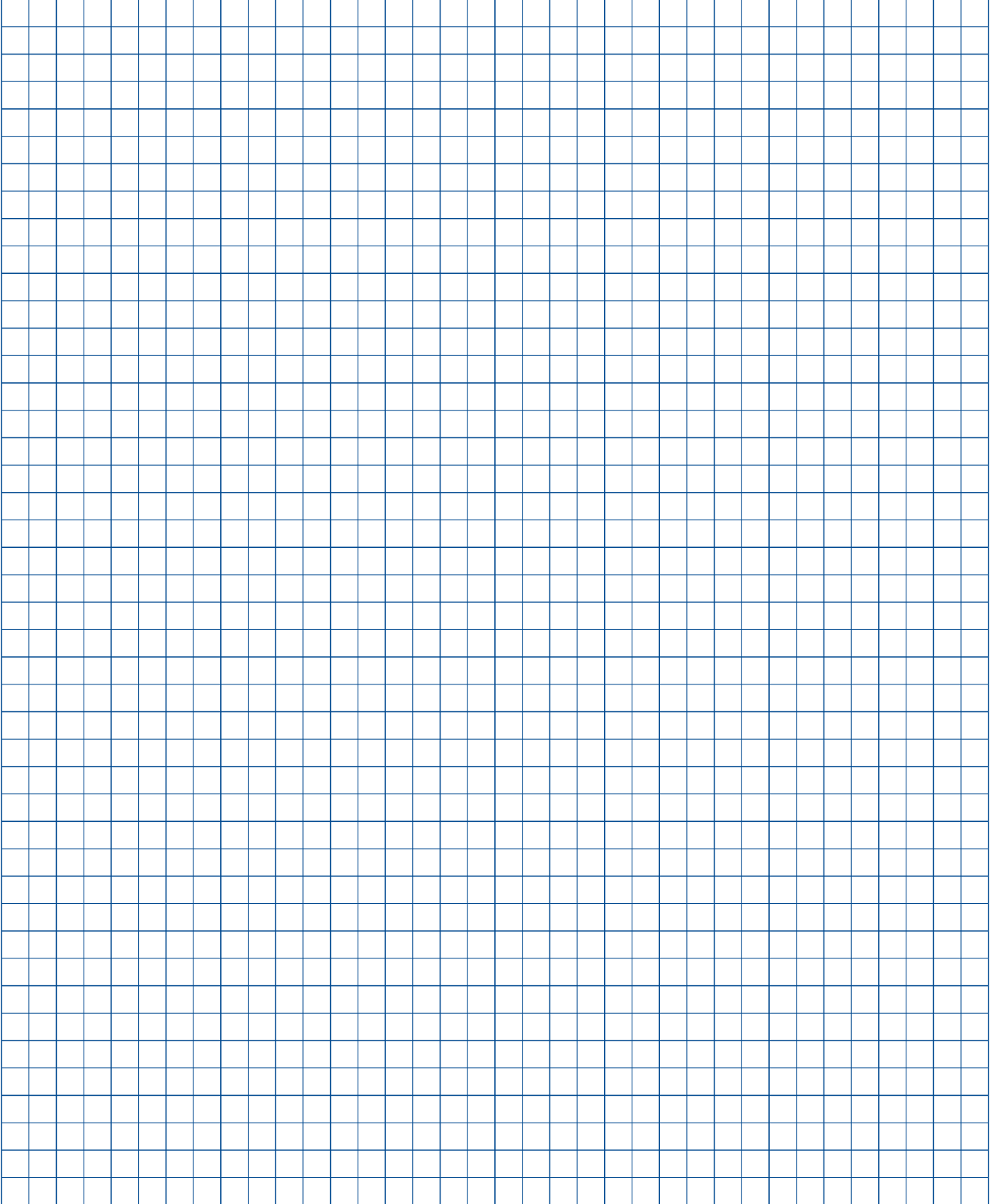

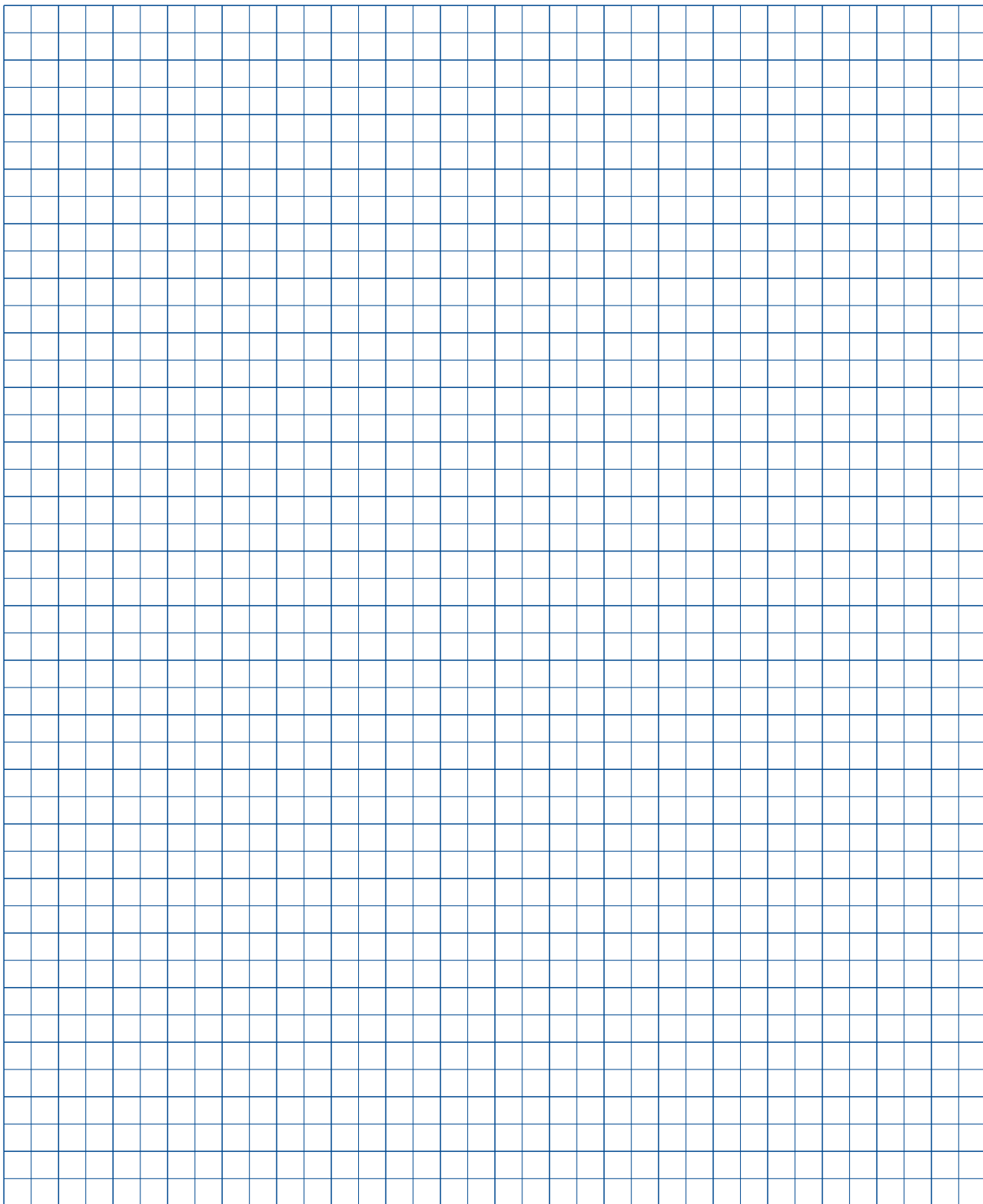



IMPPUMPS

THE HONEST PRODUCT FOR THE HONEST PRICE

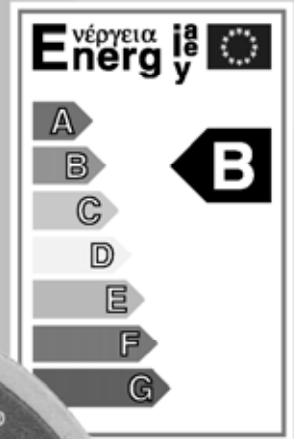

Typ:
GHN 25/40



(EU)
TF 110
230 V / 50 Hz
IP 44 class H
Max 10 bar

In (A)	Pi (W)
0,17	40 (1)
0,29	67 (2)
0,39	90 (3)

CIRCULATING
PUMP

UMWÄLZPUMPE

Who are we?

- company founded in 1946
- export more than 85% of Company's products
- worldwide sales
- whole pallet of products for HVAC applications
- real value for money
- superior service
- superior customer training

Wer sind wir?

- Gegründet im Jahr 1946
- Exportiert mehr als 85% die Firma Produkte
- Weltweit verkaufen
- Kompletten Produktpalette für Heizung, Klimatisierung und Lüftung
- "Value for money"
- Vorzüglichem Service und Kundendienst
- Die ständig für Kundenausbildung sorgt

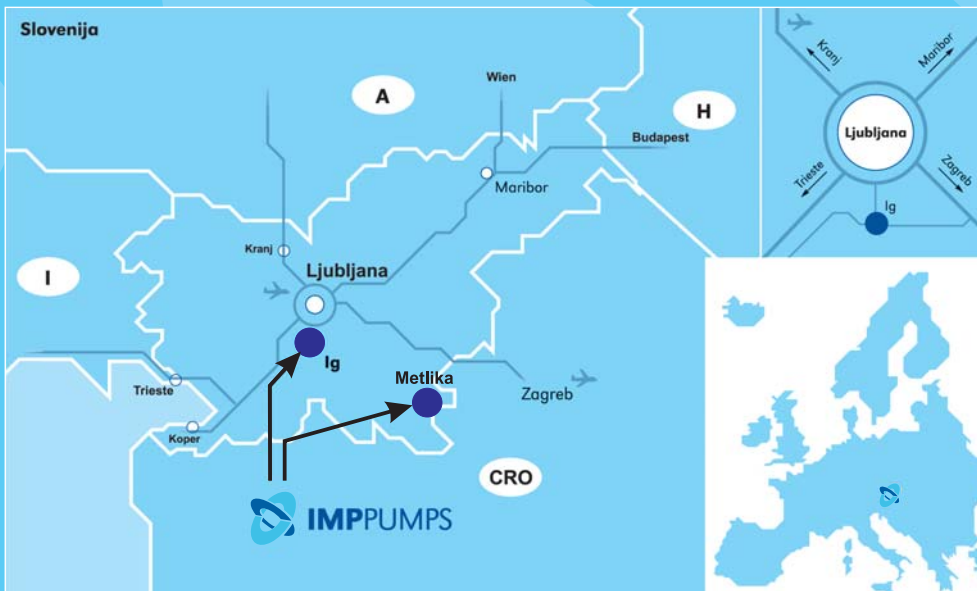

IMP PUMPS, d.o.o.
ZAGORICA 18
SI - 1292 IG SLOVENIA

TEL: +386 1 2806 400
FAX: +386 1 2806 460
E-POŠTA: info@imp-pumps.com

www.imp-pumps.com

Your IMP Pumps representative: / Ihre Ansprechpartner: